

 **Draco MultiView 4K₆₀**

Series MV42



Document MV42_en

Edition: 2020-06-10

Firmware version: 01.03

Software version: 1.1.1.0

Introduction



This manual contains important safety instructions as well as instructions for setting up the product and operating it. Please read the general safety instructions (see chapter 2, page 10) and additional notice in the respective chapters. Read carefully through the User Manual before you switch on the product.

Product identification

The model and serial number of your products are indicated on the bottom of our products. Always refer to this information when you need to contact your dealer or the support of Ihse GmbH (see chapter 11, page 118).

Trademarks and trade names

All trademark and trade names mentioned in this document are acknowledged to be the property of their respective owners.

Validity of this manual

This manual applies to all products of the series named on the cover page. Where there are differences between the various models they are clearly described.

The manufacturer reserves the right to change specifications, functions or circuitry of the series described here without notice. Information in this manual can be changed, expanded or deleted without notice. You can find the current version of the manual in the download area of our website.

Copyright

© 2020. All rights reserved. This manual may not be reproduced in any manner without the prior written consent of the manufacturer.

Available documentation

Name	Format	Description	Provision
User Manual	PDF	Provides an overview of the product together with technical data and safety instructions. Contains all instructions required to operate the product to a basic level.	Download from website
Quick Setup	Print	Provides a quick installation guide and safety instructions	Contained in the scope of delivery

Contact

IHSE GmbH
Benzstraße 1
88094 Oberteuringen
Germany
phone: +49 7546-9248-0
fax: +49 7546-9248-48
mail: info@ihse.com
website: <https://www.ihse.com>

Table of Contents

- 1 Important Information..... 8**
 - 1.1 Symbols for Warnings and Helpful Information 8
 - 1.2 Spellings 8
 - 1.3 Intended Use 9
 - 1.4 EU Declaration of Conformity..... 9
- 2 Safety instructions10**
- 3 Description.....11**
 - 3.1 Access Options.....11
 - 3.2 System Overview.....12
 - 3.2.1 Single-Head Installation12
 - 3.2.2 Dual-Head Installation.....13
 - 3.2.3 Display Modes14
 - 3.2.4 Display Order14
 - 3.3 Product Range.....15
 - 3.4 Scope of Delivery.....15
 - 3.5 Accessories16
 - 3.6 Device Views17
 - 3.6.1 Overview Draco MultiView 4K₆₀17
 - 3.6.2 Ports for CPUs, USB Devices, Service and External Keyboard.....17
 - 3.6.3 Ports for Video/Audio, DisplayPort 1.2, Single-Head18
 - 3.6.4 Ports for Video/Audio, DisplayPort 1.2, Dual-Head18
 - 3.6.5 Ports for Video/Audio, HDMI 2.0, Single-Head19
 - 3.6.6 Ports for Video/Audio, HDMI 2.0, Dual-Head19
 - 3.6.7 Ports for Network and Power Supply.....20
 - 3.7 Status Information at the Device20
 - 3.7.1 Status LED for Switching Status20
 - 3.7.2 Status LEDs for Video / Audio Input, DisplayPort 1.2, Single-Head21
 - 3.7.3 Status LEDs for Video / Audio Input, DisplayPort 1.2, Dual-Head22
 - 3.7.4 Status LEDs for Video / Audio Input, HDMI 2.0, Single-Head.....23
 - 3.7.5 Status LEDs for Video / Audio Input, HDMI 2.0, Dual-Head24
 - 3.7.6 Status LEDs of the Network and Power Supply Ports25
 - 3.8 Control Options via OSD.....26
 - 3.8.1 Command Mode26
 - 3.8.2 OSD Keyboard Control28
 - 3.8.3 OSD Menu Structure.....29
 - 3.9 Control Options via Management Software.....30
 - 3.9.1 Management Software Menu Structure.....30
 - 3.9.2 Management Software Toolbar32

3.9.3	Management Software Mouse Control	32
3.9.4	Management Software Keyboard Control	32
3.9.5	Management Software Reload Options	33
3.9.6	Management Software Context Function	33
3.9.7	Management Software Sort Function.....	34
3.9.8	Management Software Filter Function	34
4	Installation	35
4.1	Connecting Draco MV to the Sink and the Sources	35
4.2	Setting Initial Configuration in the OSD.....	36
4.3	Installing Management Software.....	36
4.4	Connecting Draco MV to the Computer	36
4.5	Starting Management Software	37
4.6	Connecting Management Software with the Draco MV	38
4.7	Device Finder	39
5	Configuration via OSD	40
5.1	Log in to the OSD	40
5.2	Log out of the OSD	41
5.3	System Settings.....	42
5.3.1	Setting OSD Options	42
5.3.2	Setting System Configuration.....	43
5.3.3	Setting Network Configuration	44
5.3.4	Setting Date and Time	47
5.3.5	Setting SNMP Function.....	49
5.4	User Settings.....	51
5.5	Setting Video Inputs and Video Outputs	52
5.5.1	Setting Video Inputs Parameters	52
5.5.2	Setting Video Outputs Parameters.....	53
5.6	Saving and Loading Configuration	54
5.6.1	Saving Active Configuration	54
5.6.2	Saving Predefined Configuration	55
5.6.3	Load Predefined Configuration	56
6	Configuration via Management Software	57
6.1	Configuring System	59
6.2	Setting Management Software Options	60
6.2.1	Setting Program Default Settings.....	60
6.2.2	Setting Font Size and Tooltip in the Toolbar	61
6.2.3	Setting Language of the Management Software	62
6.2.4	Setting Autostart of the Device Finder.....	62
6.3	System Settings.....	63
6.3.1	Setting System Configuration.....	63

- 6.3.2 Setting Network Configuration.....65
- 6.3.3 Setting Syslog Function67
- 6.3.4 Setting SNMP Function.....70
- 6.3.5 Setting Date and Time74
- 6.4 Configuration of Video Ports76
 - 6.4.1 Setting Video Inputs Parameters.....76
 - 6.4.2 Setting Video Outputs Parameters77
- 6.5 User Settings78
- 6.6 Saving Configuration.....80
 - 6.6.1 Saving Active Configuration to the Draco MV.....80
 - 6.6.2 Uploading Predefined Configurations to the Draco MV81
 - 6.6.3 Saving of Predefined Configurations Locally83
- 6.7 Activating Predefined Configuration84
- 6.8 Downloading Predefined Configuration from the Draco MV85
- 6.9 Opening Locally Saved Configuration86
- 7 Operation87**
 - 7.1 Switching a Source87
 - 7.1.1 Switching via Keyboard.....87
 - 7.1.2 Switching via External Keypad87
 - 7.1.3 Switching via OSD87
 - 7.2 Changing Display Mode.....88
 - 7.2.1 Changing Display Mode via Keyboard88
 - 7.2.2 Changing Display Mode via OSD.....88
 - 7.3 Querying Status for Diagnosis via OSD89
 - 7.3.1 Network Status.....89
 - 7.3.2 Firmware Status.....90
 - 7.3.3 Trace91
 - 7.4 Querying Status for Diagnosis via Management Software92
 - 7.4.1 Device Status.....92
 - 7.4.2 Network Status.....93
 - 7.4.3 Firmware Status.....94
 - 7.4.4 Syslog Monitoring95
 - 7.4.5 SNMP Monitoring.....97
 - 7.5 Saving Status via Management Software.....99
 - 7.6 Opening Locally Saved Status via Management Software100
 - 7.7 Updating Firmware via Service Port.....100
 - 7.8 Updating Firmware via Management Software.....101
 - 7.9 Power On and Power Down Functions via OSD103
 - 7.9.1 Power Down Draco MV.....103
 - 7.9.2 Restart MV.....104

7.9.3	Factory Reset	105
7.10	Power On and Power Down Functions via Management Software	106
7.10.1	Power Down Draco MV.....	106
7.10.2	Restart MV.....	107
7.10.3	Factory Reset	108
8	Specifications	109
8.1	Interfaces.....	109
8.1.1	DisplayPort	109
8.1.2	HDMI	109
8.1.3	USB-HID.....	110
8.1.4	USB 2.0 (transparent).....	110
8.1.5	Mini-USB	110
8.1.6	GPIO Port.....	111
8.1.7	RJ45 (Interconnect).....	111
8.1.8	3,5 mm Audio Interface (Optical Digital / Analog).....	111
8.2	Connector Pinouts	112
8.2.1	DisplayPort - Upstream.....	112
8.2.2	DisplayPort - Downstream	112
8.2.3	HDMI	112
8.2.4	USB, Type A.....	113
8.2.5	USB, Type B.....	113
8.2.6	Mini-USB, Type B	113
8.2.7	D-Sub 9 (GPIO).....	113
8.2.8	Mini-Toslink	113
8.2.9	RJ45 (Interconnect).....	114
8.3	Power Supply and Power Consumption.....	114
8.4	Environmental Conditions and Emissions	114
8.5	Dimensions.....	114
8.6	Weight.....	114
8.7	MTBF	115
9	Maintenance.....	115
10	Troubleshooting	116
10.1	Network Error	116
10.2	Failure at the Draco MV.....	116
10.3	Failure at the USB-HID Port.....	116
10.4	Video Interference	116
10.5	Blank Screen	117
11	Technical Support.....	118
11.1	Support Checklist	118
11.2	Shipping Checklist.....	118

12	Certificates/Directives	119
12.1	North American Regulatory Compliance	119
12.2	WEEE	119
12.3	RoHS	119
13	EU Declaration of Conformity	120
14	Glossary	121

1 Important Information

1.1 Symbols for Warnings and Helpful Information

The meaning of the symbols used for warnings and helpful information in this manual is described below:

NOTICE

NOTICE identifies information, if not observed, endangers the functionality of your device or the security of your data.



This symbol indicates information about special features on the device or when using device and function variants.



This symbol indicates instructions for procedures recommended by the manufacturer for an effective utilization of the device potential.

1.2 Spellings

Uniform spellings are used in this manual for better readability or easier assignment.

The following spellings are used for products:

Product	Description
Draco MultiView 4K ₆₀	Draco MV
Draco MV-Tool	Management software
Source	Computer, CPU
Sink	Console (monitor, keyboard, mouse)

The following spellings are used for keyboard commands:

Keyboard command	Description
<key>	Description of a key on the keyboard
<key> + <key>	Press keys simultaneously
<key>, <key>	Press keys successively
2x <key>	Press key quickly, twice in a row (like a mouse double-click)

The following spellings are used for software descriptions:

Spelling	Description
Bold print	Description of terms that are used in the device software
Menu item	Description of a menu item in the software
Menu item > Menu item	Select menu items successively

1.3 Intended Use

The Draco MV is used to display video signals of up to four sources (computer, CPU) at one console at monitor (Single-Head variant) or two monitors (Dual-Head variant). A redundant display on a second console is possible.

The operation of the sources can be executed or keyboard commands or a special keyboard.

NOTICE

Possible radio interference in a domestic environment

This is a Class A product. In a domestic environment, this product may cause radio interference in which case the user may be required to take adequate measures.

The safety instructions and installation instructions noted in this manual shall be considered in detail. Compliance with the specifications for cable lengths and types is mandatory.

1.4 EU Declaration of Conformity

For information about the Declaration of Conformity refer to chapter 13, page 120. A copy of the original, product-specific EU Declaration of Conformity can be requested. For contact details, see page 2 of this manual.

2 Safety instructions

To ensure reliable and safe long-term operation of your device please note the following guidelines:

- Read this user manual carefully.
- Only use the device according to this user manual. Failure to follow the instructions described can damage the device or endanger the security of your data.
- Take any required ESD precautions.

Installation location

While operating the device can get warm. Damage to the device can occur in a damp environment.

- Use the device only in dry, indoor environments.
- Use the device only in a room with adequate ventilation.
- Existing ventilation openings on the device must always be free.
- Place all power outlets easily accessible and directly next to each other.

Connection

- Check the device for visible damage before connecting it.
- Only connect the device if the device and the ports are not damaged.
- Place all power outlets easily accessible and directly next to each other.

Disconnect the device from the circuit

NOTICE

The cable plugs on the device side can contain a lock. In the event of a necessary quick disconnection from the circuit:

- all corresponding cable plugs have to be removed from the socket,
- or set the power switch of the power outlets (if available) to the “Off” position.

3 Description

3.1 Access Options

You have following options to configure and operate the Draco MV:

Access option	Description
OSD	Firmware contained in Draco MV, no additional PC necessary: Via OSD (On-Screen-Display) you can configure the basic settings of the Draco MV operating system and query several status. The Draco MV includes a command mode that allows to open the OSD and to control several functions by keyboard commands during operation.
Draco MV-Tool	The Draco MV-Tool (management software) is available as a single executable program file that does not require a separate installation. Advanced settings can be configured on the Draco MV operating system using the management software: <ul data-bbox="544 712 1023 851" style="list-style-type: none">• Advanced configuration• Extended monitoring options• System update (firmware update)• Local backup option

3.2 System Overview

3.2.1 Single-Head Installation

A Draco MV system with Single-Head consists of a Draco MV, one or more sources (computer, CPU) and one sink (console with monitor, keyboard, and mouse). The Draco MV is directly connected to the sources and sink via connecting cables.

The audio signals of all sources are transmitted to the Draco MV simultaneously. However, only the audio signal of the active source is output.



Redundant video and audio output:

A second monitor can be installed at the redundant video output. The display mode, the sequence, and the content on monitor 2 correspond to that on monitor 1.

When a second loudspeaker is connected to the redundant audio output, also the audio signal of the active source is output.

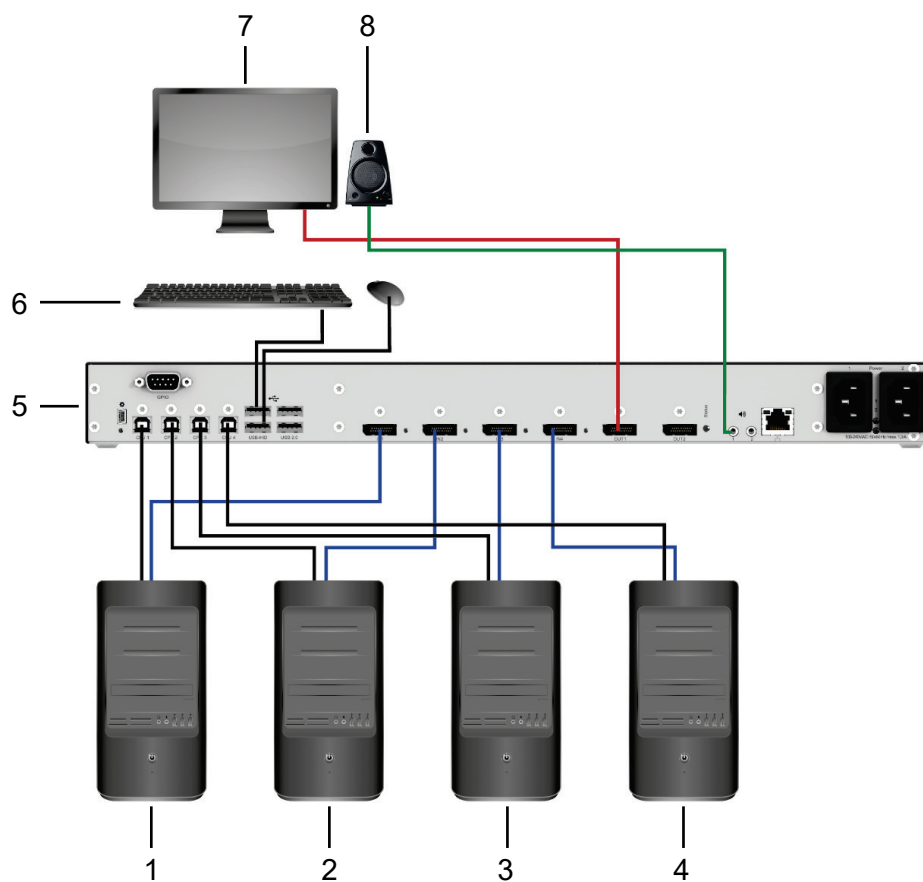

Fig. 1 System overview (example = Single-Head installation)

- | | |
|---------|--|
| 1 CPU 1 | 5 Draco Multiview 4K ₆₀ |
| 2 CPU 2 | 6 USB-HID devices (e.g. keyboard, mouse) |
| 3 CPU 3 | 7 Video (monitor) |
| 4 CPU 4 | 8 Audio (e.g. speaker) |

3.2.2 Dual-Head Installation

A Draco MV system with Dual-Head consists of a Draco MV, one or more sources (computer, CPU) and one sink (console with 2 monitor, keyboard, and mouse). The Draco MV is directly connected to the sources and sink via connecting cables.

The audio signals of all sources are transmitted to the Draco MV simultaneously. However, only the audio signal of the active source is output.



Redundant video and audio output:

Additional output devices (up to 2 monitors and 2 loudspeakers) can optionally be connected to the redundant video and audio outputs. For example, video signal 1 of console 2 corresponds to the video signal 1 of console 1. The audio signal 1 of console 2 also corresponds to the audio signal 1 of console 1.

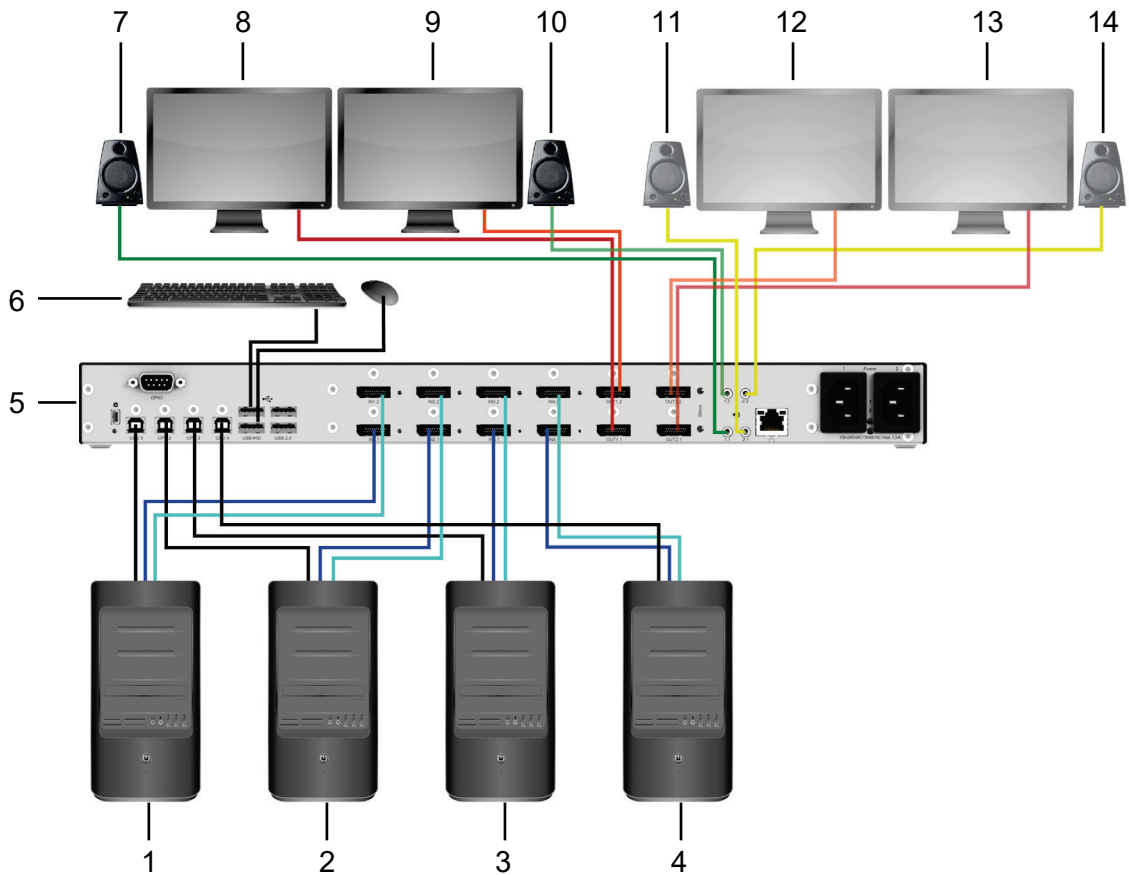

Fig. 2 System overview (example = Dual-Head installation)

- | | |
|---|--|
| 1 CPU 1 | 9 Console 1, video 2 (monitor 2) |
| 2 CPU 2 | 10 Console 1, audio 2 (e.g. speaker) |
| 3 CPU 3 | 11 Console 2, audio 1 (e.g. speaker)
(redundancy) |
| 4 CPU 4 | 12 Console 2, video 1 (monitor 1)
(redundancy) |
| 5 Draco Multiview 4K ₆₀ | 13 Console 2, video 2 (monitor 2)
(redundancy) |
| 6 Console 1, USB-HID devices (e.g. keyboard, mouse) | 14 Console 2, audio 2 (e.g. speaker)
(redundancy) |
| 7 Console 1, audio 1 (e.g. speaker) | |
| 8 Console 1, video 1 (monitor 1) | |

3.2.3 Display Modes

On a monitor various display modes of video signals are available

- Video signal of only one source (Fullscreen)
- Video signal of up to four sources (Multiview 4:1, Quad Split)
- Video signal of up to four sources (MultiView 4:1, Picture-in-Picture)

The display mode can be set or changed via OSD or via management software.



Fig. 3 Display modes

3.2.4 Display Order

Display Mode Quad Split

In display mode Quad Split the arrangement of the displayed sources is always retained after switching to another source. When switched from source 1 to source 3, screen 3 is activated and the mouse can be used within this screen.

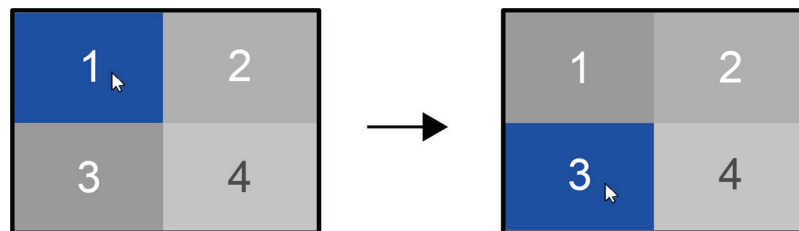

Fig. 4 Display mode Quad Split - example for display order after switching

Display Mode Picture-in-Picture (PiP)

In display mode Picture-in-Picture the arrangement of the displayed sources is changed after switching to another source. When switched from source 1 to source 3, screen 3 is displayed in the active screen area and the mouse can be used within this screen. The arrangement of the screens shown on the right corresponds to the sources in numerically ascending order.

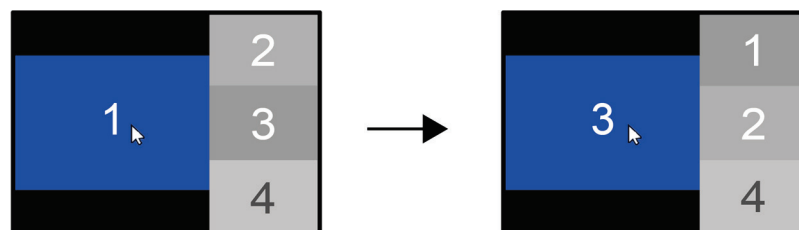

Fig. 5 Display Mode Picture-in-Picture - example for display order after switching

3.3 Product Range

Part No.	Description	
MV42-DPSH	Input	Up to 4x DP 1.2 with total 4K60, 4x USB
	Output	Up to 2x DP 1.2 with total 4K60, 2x USB-HID and 2x USB 2.0 Up to 2x audio (3,5 mm, optical digital / analog)
MV42-DPDH	Input	Up to 8x DP 1.2 with total 4K60, 4x USB
	Output	Up to 4x DP 1.2 with total 4K60, 2x USB-HID and 2x USB 2.0 Up to 4x audio (3,5 mm, optical digital / analog)
MV42-H2SH	Input	Up to 4x HDMI 2.0 with total 4K60, 4x USB
	Output	Up to 2x HDMI 2.0 with total 4K60, 2x USB-HID and 2x USB 2.0 Up to 2x audio (3,5 mm, optical digital / analog)
MV42-H2DH	Input	Up to 8x HDMI 2.0 with total 4K60, 4x USB
	Output	Up to 4x HDMI 2.0 with total 4K60, 2x USB-HID and 2x USB 2.0 Up to 4x audio (3,5 mm, optical digital / analog)

3.4 Scope of Delivery

The scope of delivery contains the following items:

Product type	Scope of delivery
MV42-DPSH	<ul style="list-style-type: none"> • Draco MultiView 4K₆₀ • 2x Europe power cord 2,0 m • 4x DisplayPort cable 2,0 m • 4x USB cable Type A-B, 1,8 m • Quick Setup
MV42-DPDH	<ul style="list-style-type: none"> • Draco MultiView 4K₆₀ • 2x Europe power cord 2,0 m • 8x DisplayPort cable 2,0 m • 4x USB cable Type A-B, 1,8 m • Quick Setup
MV42-H2SH	<ul style="list-style-type: none"> • Draco MultiView 4K₆₀ • 2x Europe power cord 2,0 m • 4x HDMI cable 1,8 m • 4x USB cable Type A-B, 1,8 m • Quick Setup
MV42-H2DH	<ul style="list-style-type: none"> • Draco MultiView 4K₆₀ • 2x Europe power cord 2,0 m • 8x HDMI cable 1,8 m • 4x USB cable Type A-B, 1,8 m • Quick Setup



If anything is missing, contact your dealer.

3.5 Accessories

Part No.	Description
247-U1	USB cable 1.8 m (Type A to B)
247-U2	USB cable 3.0 m (Type A to B)
436-HD	HDMI cable 1.8 m
436-DP	DisplayPort cable 1.8 m
436-USB20	USB extension cable 3.0 m (Type A to A)
455-CK	Stereo jack cable 1.6 m (3.5 mm Stereo)
474-6RMK	19"/1U rack mount kit for 6-fold chassis

3.6 Device Views

The following views of the Draco MultiView 4K₆₀ illustrate the currently available variants:

3.6.1 Overview Draco MultiView 4K₆₀



Fig. 6 Front side

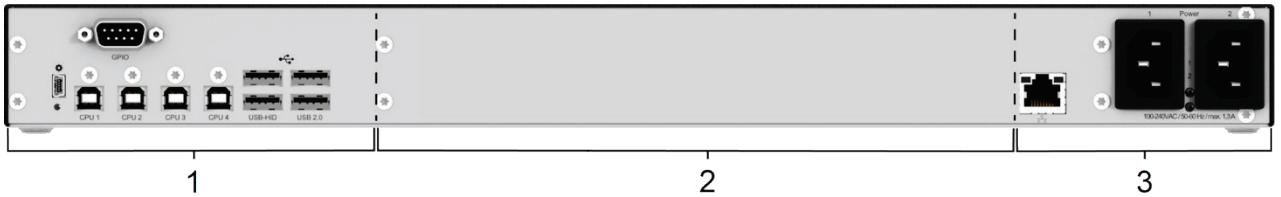

Fig. 7 Connection side

- 1 Ports for USB, service, and external keyboard
- 2 Ports for video/audio inputs and outputs (see below)
- 3 Ports for network and power supply

3.6.2 Ports for CPUs, USB Devices, Service and External Keyboard

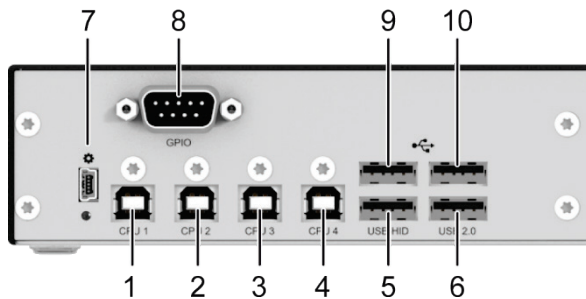

Fig. 8 Connection side

- 1 From CPU 1: USB-HID and USB 2.0
- 2 From CPU 2: USB-HID and USB 2.0
- 3 From CPU 3: USB-HID and USB 2.0
- 4 From CPU 4: USB-HID and USB 2.0
- 5 Port 1 for USB-HID device
- 6 Port 1 for USB 2.0 device
- 7 Service port
- 8 Port for external keyboard
- 9 Port 2 for USB-HID device
- 10 Port 2 for USB 2.0 device

3.6.3 Ports for Video/Audio, DisplayPort 1.2, Single-Head

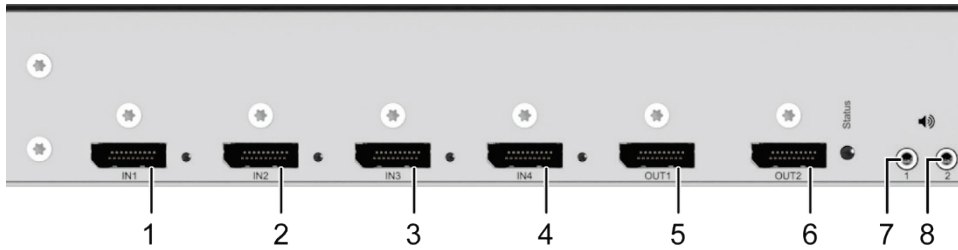

Fig. 9 Connection side

- | | |
|-----------------------------|---|
| 1 DP 1.2 Input 1 from CPU 1 | 5 DP 1.2 Output 1 to CON 1 |
| 2 DP 1.2 Input 1 from CPU 2 | 6 DP 1.2 Output 1 to CON 2 (redundancy) |
| 3 DP 1.2 Input 1 from CPU 3 | 7 Audio output 1 |
| 4 DP 1.2 Input 1 from CPU 4 | 8 Audio output 2 (redundancy) |

3.6.4 Ports for Video/Audio, DisplayPort 1.2, Dual-Head

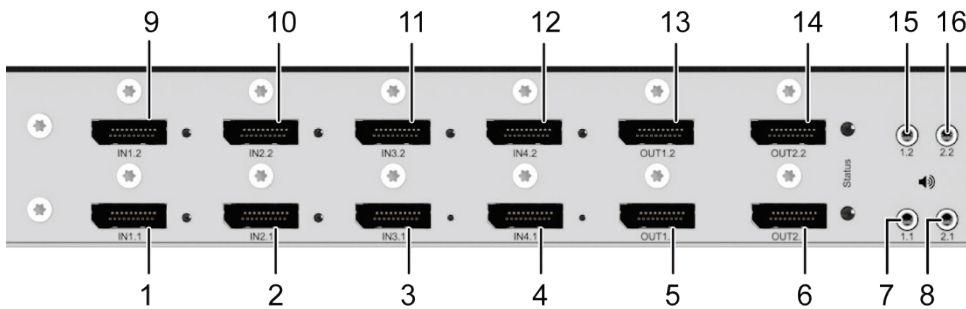

Fig. 10 Connection side

- | | |
|---|--|
| 1 DP 1.2 Input 1 from CPU 1 | 9 DP 1.2 Input 2 from CPU 1 |
| 2 DP 1.2 Input 1 from CPU 2 | 10 DP 1.2 Input 2 from CPU 2 |
| 3 DP 1.2 Input 1 from CPU 3 | 11 DP 1.2 Input 2 from CPU 3 |
| 4 DP 1.2 Input 1 from CPU 4 | 12 DP 1.2 Input 2 from CPU 4 |
| 5 DP 1.2 Output 1 to CON 1 | 13 DP 1.2 Output 2 to CON 1 |
| 6 DP 1.2 Output 1 to CON 2 (redundancy) | 14 DP 1.2 Output 2 to CON 2 (redundancy) |
| 7 Audio output 1.1 | 15 Audio output 1.2 |
| 8 Audio output 2.1 (redundancy) | 16 Audio output 2.2 (redundancy) |

3.6.5 Ports for Video/Audio, HDMI 2.0, Single-Head

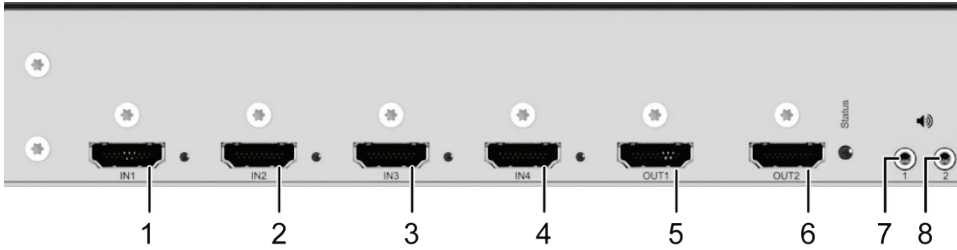

Fig. 11 Connection side

- | | |
|-------------------------------|---|
| 1 HDMI 2.0 Input 1 from CPU 1 | 5 HDMI 2.0 Output 1 to CON 1 |
| 2 HDMI 2.0 Input 1 from CPU 2 | 6 HDMI 2.0 Output 1 to CON 2 (redundancy) |
| 3 HDMI 2.0 Input 1 from CPU 3 | 7 Audio output 1 |
| 4 HDMI 2.0 Input 1 from CPU 4 | 8 Audio output 2 (redundancy) |

3.6.6 Ports for Video/Audio, HDMI 2.0, Dual-Head

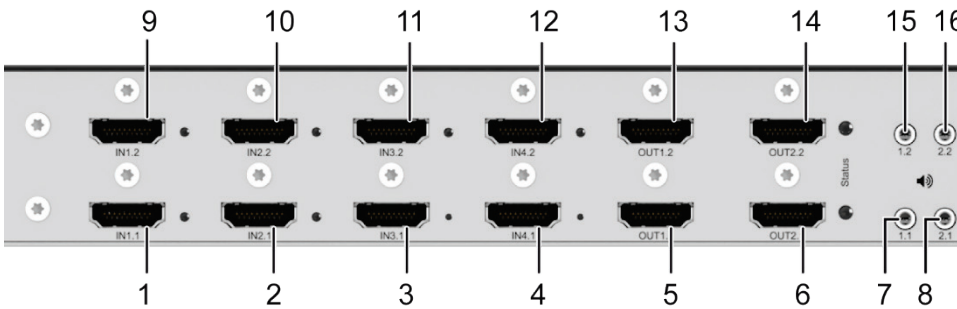

Fig. 12 Connection side

- | | |
|---|--|
| 1 HDMI 2.0 Input 1 from CPU 1 | 9 HDMI 2.0 Input 2 from CPU 1 |
| 2 HDMI 2.0 Input 1 from CPU 2 | 10 HDMI 2.0 Input 2 from CPU 2 |
| 3 HDMI 2.0 Input 1 from CPU 3 | 11 HDMI 2.0 Input 2 from CPU 3 |
| 4 HDMI 2.0 Input 1 from CPU 4 | 12 HDMI 2.0 Input 2 from CPU 4 |
| 5 HDMI 2.0 Output 1 to CON 1 | 13 HDMI 2.0 Output 2 to CON 1 |
| 6 HDMI 2.0 Output 1 to CON 2 (redundancy) | 14 HDMI 2.0 Output 2 to CON 2 (redundancy) |
| 7 Audio output 1.1 | 15 Audio output 1.2 |
| 8 Audio output 2.1 (redundancy) | 16 Audio output 2.2 (redundancy) |

3.6.7 Ports for Network and Power Supply

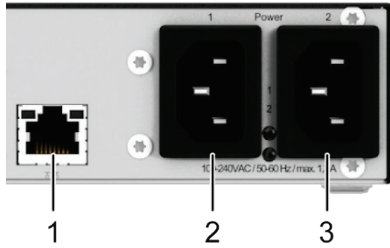

Fig. 13 Connection side

- | | | | |
|---|-------------------------|---|--------------------------------------|
| 1 | Port for network (RJ45) | 3 | Port for power supply 2 (redundancy) |
| 2 | Port for power supply 1 | | |

3.7 Status Information at the Device

The Draco MV is equipped with the following LEDs for status information:

3.7.1 Status LED for Switching Status

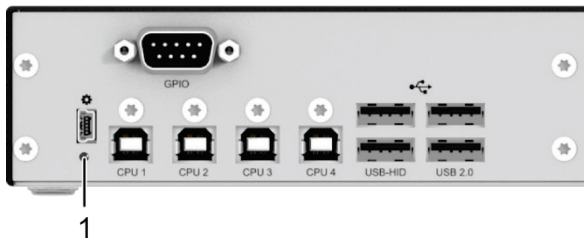

Fig. 14 Connection side

Status LED for switching status

Pos.	LED	Status	Description
1	Status (red)	1x flashing	Switched to CPU 1
		2x flashing	Switched to CPU 2
		3x flashing	Switched to CPU 3
		4x flashing	Switched to CPU 4

3.7.2 Status LEDs for Video / Audio Input, DisplayPort 1.2, Single-Head

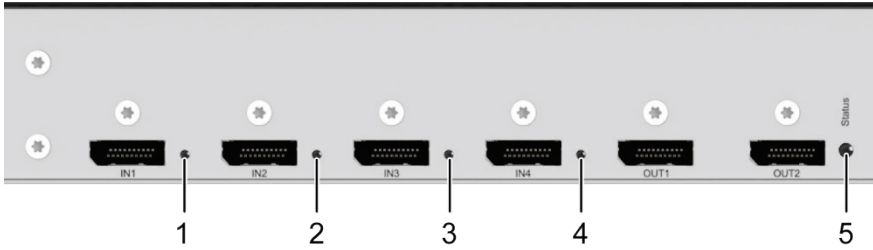





Fig. 15 Connection side

- | | | | |
|---|------------------------------|---|------------------------------|
| 1 | Status LED, input from CPU 1 | 4 | Status LED, input from CPU 4 |
| 2 | Status LED, input from CPU 2 | 5 | Status LED, operating status |
| 3 | Status LED, input from CPU 3 | | |

Status LEDs for video / audio input and system status

Pos.	LED	Status	Description
1-4	Status (green)	Off	No connection to the source (computer, CPU) or connection available, but connection not activated
		On	Connection to the source (computer, CPU) available, connection activated and data traffic active
5	Operating status (multi-color)	Off	System is off, no power supply voltage
		Solid  > off	System is booting
		Flashing 	System is ready
		Solid  > off > flashing 	System is shutting down

3.7.3 Status LEDs for Video / Audio Input, DisplayPort 1.2, Dual-Head

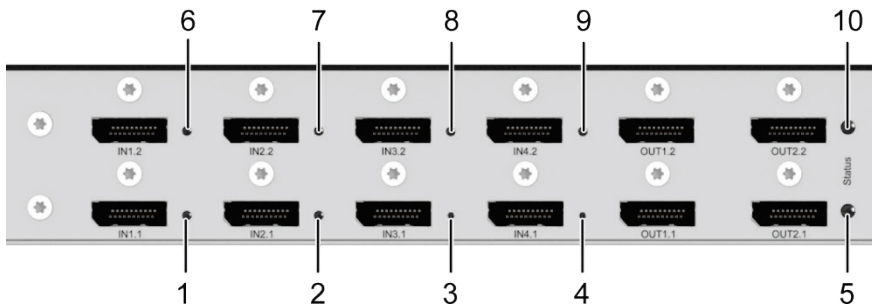





Fig. 16 Connection side

- | | | | |
|---|--------------------------------|----|--------------------------------|
| 1 | Status LED, input 1 from CPU 1 | 6 | Status LED, input 2 from CPU 1 |
| 2 | Status LED, input 1 from CPU 2 | 7 | Status LED, input 2 from CPU 2 |
| 3 | Status LED, input 1 from CPU 3 | 8 | Status LED, input 2 from CPU 3 |
| 4 | Status LED, input 1 from CPU 4 | 9 | Status LED, input 2 from CPU 4 |
| 5 | Status LED, operating status 1 | 10 | Status LED, operating status 2 |

Status LEDs for video / audio input and system status

Pos.	LED	Status	Description
1-4, 6-9	Status (green)	Off	No connection to the source (computer, CPU) or connection available, but connection not activated
		On	Connection to the source (computer, CPU) available, connection activated and data traffic active
5, 10	Operating status (multi-color)	Off	System is off, no power supply voltage
		Solid  > off	System is booting
		Flashing 	System is ready
		Solid  > off > flashing 	System is shutting down

3.7.4 Status LEDs for Video / Audio Input, HDMI 2.0, Single-Head

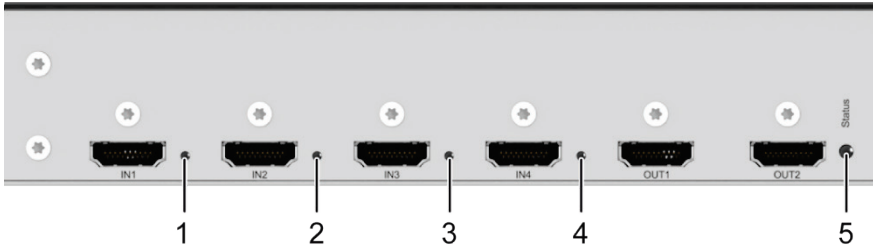





Fig. 17 Connection side

- | | | | |
|---|------------------------------|---|------------------------------|
| 1 | Status LED, input from CPU 1 | 4 | Status LED, input from CPU 4 |
| 2 | Status LED, input from CPU 2 | 5 | Status LED, operating status |
| 3 | Status LED, input from CPU 3 | | |

Status LEDs for video / audio input and system status

Pos.	LED	Status	Description
1-4	Status (green)	Off	No connection to the source (computer, CPU) or connection available, but connection not activated
		On	Connection to the source (computer, CPU) available, connection activated and data traffic active
5	Operating status (multi-color)	Off	System is off, no power supply voltage
		Solid  > off	System is booting
		Flashing 	System is ready
		Solid  > off > flashing 	System is shutting down

3.7.5 Status LEDs for Video / Audio Input, HDMI 2.0, Dual-Head

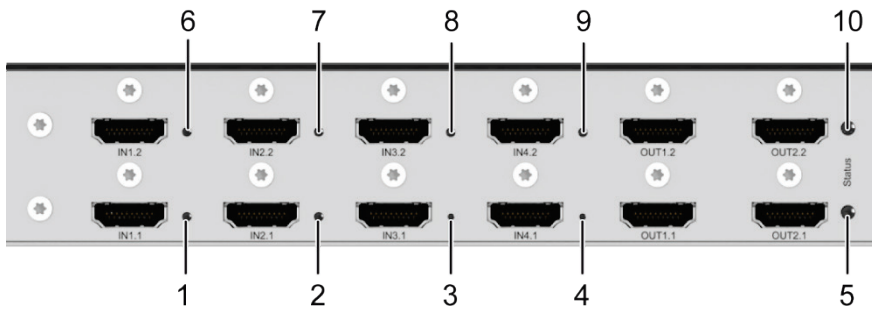





Fig. 18 Connection side

- | | | | |
|---|--------------------------------|----|--------------------------------|
| 1 | Status LED, input 1 from CPU 1 | 6 | Status LED, input 2 from CPU 1 |
| 2 | Status LED, input 1 from CPU 2 | 7 | Status LED, input 2 from CPU 2 |
| 3 | Status LED, input 1 from CPU 3 | 8 | Status LED, input 2 from CPU 3 |
| 4 | Status LED, input 1 from CPU 4 | 9 | Status LED, input 2 from CPU 4 |
| 5 | Status LED, operating status 1 | 10 | Status LED, operating status 2 |

Status LEDs for video / audio input and system status

Pos.	LED	Status	Description
1-4, 6-9	Status (green)	Off	No connection to the source (computer, CPU) or connection available, but connection not activated
		On	Connection to the source (computer, CPU) available, connection activated and data traffic active
5, 10	Operating status (multi-color)	Off	System is off, no power supply voltage
		Solid  > off	System is booting
		Flashing 	System is ready
		Solid  > off > flashing 	System is shutting down

3.7.6 Status LEDs of the Network and Power Supply Ports

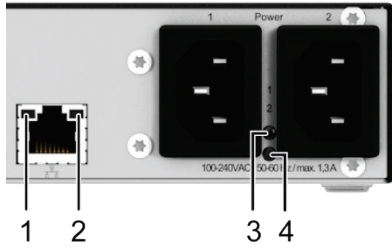

Fig. 19 Connection side

- | | | | |
|---|-------------------------------------|---|-------------------------------|
| 1 | Status LED 1 for network connection | 3 | Status LED 1 for power supply |
| 2 | Status LED 2 for network connection | 4 | Status LED 2 for power supply |

Status LEDs of the network port

Pos.	LED	Status	Description
1	Activity status (green)	Off	No network connection available
		Flashing	Network connection available
2	Link status (orange)	Off	No network connection available or no data transfer
		On	Network connection available, data transfer active

Status LEDs of the power supply port

Pos.	LED	Status	Description
3	DC Input (green)	Off	No power supply voltage available
		On	Power supply available
	DC Input (red)	Off	No power supply voltage available
		On	Power supply available
4	DC Input (green)	Off	No power supply voltage available
		On	Power supply available
	DC Input (red)	Off	No power supply voltage available
		On	Power supply available

3.8 Control Options via OSD

3.8.1 Command Mode

The Draco MV includes a command mode that allows to configure several functions to be controlled by keyboard commands during normal operation.

To access the command mode, use a 'Hot Key' sequence at the keyboard plugged in the Draco MV and press <Esc> to exit the command mode. While in command mode, the LEDs **Caps Lock** and **Scroll Lock** on the keyboard will flash.

The following spellings are used for keyboard commands:

Keyboard command	Description
<key>	Description of a key on the keyboard
<key> + <key>	Press keys simultaneously
<key>, <key>	Press keys successively
2x <key>	Press key quickly, twice in a row (like a mouse double-click)

NOTICE

In command mode, USB-HID devices will cease. Only selected keyboard commands are available.

If there is no keyboard command executed within 10 s after activating the command mode, it will be deactivated automatically.

The following keyboard commands are used to enter and to exit the command mode and to change the 'Hot Key'.

Function	Keyboard command
Enter command mode (default)	2x <Right Shift> (bzw. 'Hot Key')
Exit command mode	<Esc>
Change 'Hot Key'	<current 'Hot Key'>, <c>, <new 'Hot Key'-Code>, <Enter>

'Hot Key'-Code

The 'Hot Key' to enter command mode can be changed. The following table lists the 'Hot Key' codes for the available 'Hot Keys'.

'Hot Key'-Code	'Hot Key'
0	Free selectable
2	2x <Scroll>
3	2x <Left Shift>
4	2x <Left Ctrl>
5	2x <Left Alt>
6	2x <Right Shift>
7	2x <Right Ctrl>
8	2x <Right Alt>

NOTICE

When installing the Draco MV with additional KVM devices (e.g. matrix, extender or U-Switch) different 'Hot Keys' for the individual devices have to be defined.

Set freely selectable 'Hot Key' (exemplary)

To set a freely selectable 'Hot Key' (e.g. 2x <Space>), use the following keyboard sequence:

```
<current 'Hot Key'>, <c>, <0>, <Space>, <Enter>
```

Set 'Hot Key' for direct OSD access

Next to the 'Hot Key' for standard functions, a second 'Hot Key' can be exclusively set for opening the OSD directly.

To select a 'Hot Key' from the 'Hot Key' table for a direct opening of the OSD, use the following keyboard sequence:

```
<current 'Hot Key'>, <f>, <'Hot Key'-Code>, <Enter>
```

To select a freely selectable 'Hot Key' (e.g. <Space>) for opening OSD directly, use the following keyboard sequence:

```
<current 'Hot Key'>, <f>, <0>, <Space>, <Enter>
```

Delete 'Hot Key' for direct OSD access

To delete the 'Hot Key' for direct OSD access, use the following keyboard sequence

```
<aktueller 'Hot Key'>, <f>, <0>, <Del>, <Enter>
```

Reset 'Hot Key'

To set a 'Hot Key' back to default settings, press the key combination <Right Shift> + within 5 s after plugging in a keyboard.

3.8.2 OSD Keyboard Control

The following keyboard commands are used to open and to exit the OSD:

Keyboard command	Function
<Hotkey>, <o>	Open OSD
<ESC>	Exit OSD (in main menu)
<Left Shift> + <ESC>	Exit OSD (within the menus)

NOTICE

If the OSD is closed with one of the keyboard commands mentioned above, possible changes are not saved. For information on saving changes, see configuration descriptions from chapter 5.6, from page 54.

The following keyboard commands are available for the navigation and configuration within the menus:

Keyboard command	Function
<Cursor Left>	Left cursor - only within an input field
<Cursor Right>	Right cursor - only within an input field
<Cursor Up>	In input fields: Line up (with wrap around)
	In menus: Line up (without wrap around)
<Cursor Down>	In input fields: Line down (with wrap around)
	In menus: Line down (without wrap around)
<Page Up>	Previous page in menus with more than one page
<Page Down>	Next page in menus with more than one page
<Tab>	Next input field
<Left Shift> + <Tab>	Previous input field
<+>	Next option in selection fields
<->	Previous option in selection fields
<Space>	Switching in selection fields between two conditions, e. g. between ON / OFF or Y (Yes) / N (No)
<Enter>	In menu with input fields: Save data
	In menus: Select menu item
	With buttons: Confirm selected button
<Esc>	In menu with input fields: Cancel data input without saving
	In menus with selection fields: Go back to the superior menu

3.8.3 OSD Menu Structure

The general layout of the OSD is structured into three areas:

- Upper status area (topmost two text lines)
- Working area
- Lower status area (lowest two text lines)

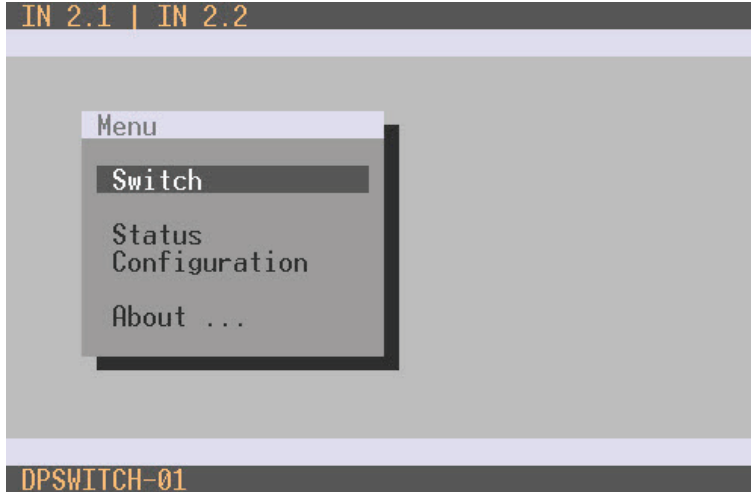

Fig. 20 Landing page of the OSD

The following functions are available in most of the menus:

Button	Function
Cancel	Reject changes
Okay	Confirm changes (temporary storage of the active configuration in the volatile memory of the Draco MV).

NOTICE

Possible loss of configuration changes

By clicking the **Okay** button, changes are overtaken to the active configuration and saved in the volatile memory of the Draco MV. In the event of a sudden power failure, these changes would be lost. To save changes permanently:

- save the changed configuration as an active (**Save**) or as a predefined configuration (**Save as...**) (from chapter 5.6, page 54) or perform a restart (see chapter 7.9.2, page 104).

3.9 Control Options via Management Software

3.9.1 Management Software Menu Structure

The menu structure of the management software is subdivided into various sections:

- Menu bar (top line)
- Toolbar (second line)
- Tab bar (third line)
- Task area (left menu section)
- Working area (right menu section)
- Status bar (bottom line)

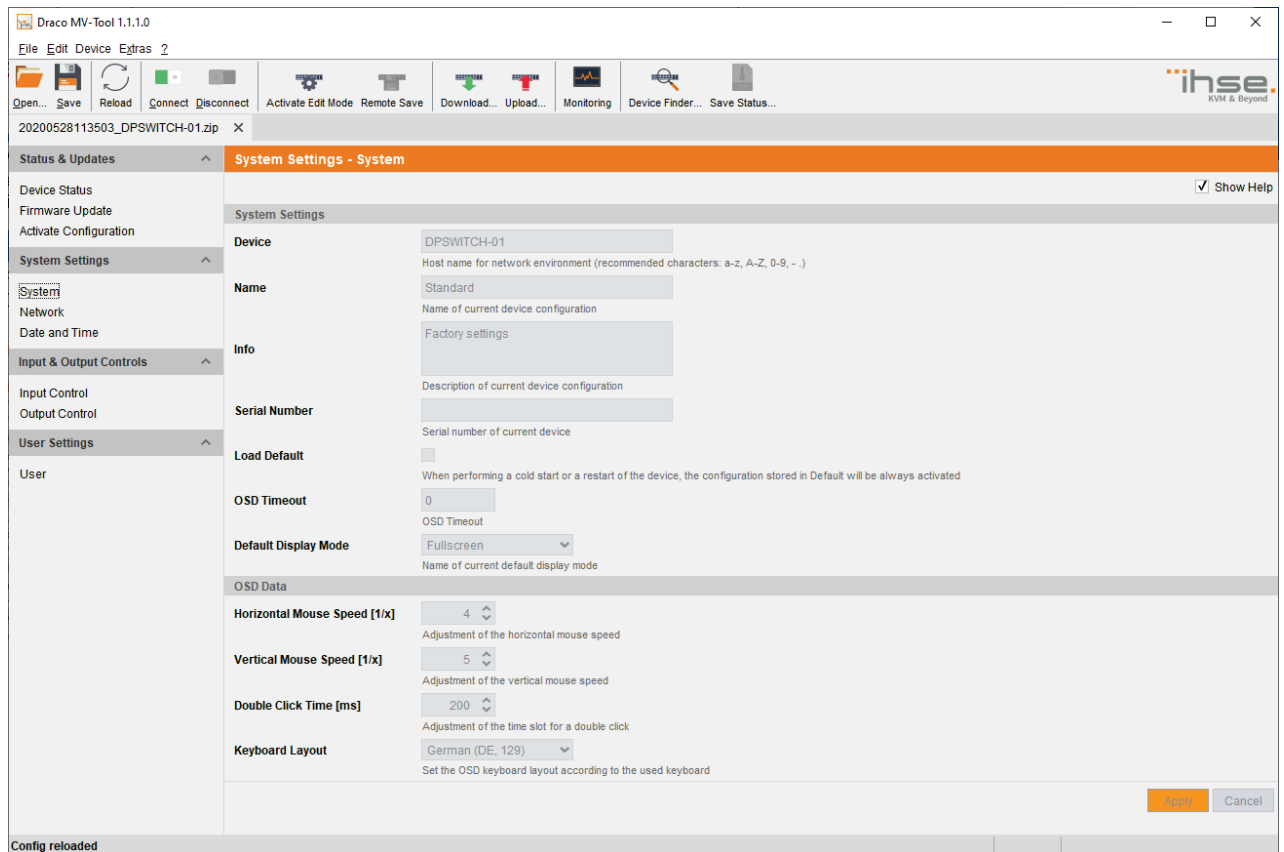

Fig. 21 Example (System Settings - System)

The following functions are available in most of the menus:

Button	Function
Apply	Confirm changes (temporary storage of the active configuration in the volatile memory of the Draco MV)
Cancel	Reject changes

NOTICE

Possible loss of changes

By clicking the **Apply** button, changes are overtaken to the active configuration and saved in the volatile memory of the Draco MV. In the event of a sudden power failure, these changes would be lost. To save changes permanently:

- save the changed configuration as an active or as a predefined configuration (see from chapter 6.6, page 80) or perform a restart (see chapter 7.10.2, page 107).

Information for operating and for support functions

The operation of the management software is intuitive and corresponds to the user interface of common operating systems.

The management software contains its own support function. The integrated help texts in the working area of the management software can be activated or deactivated by the checkbox in the upper right corner. Auxiliary names (tooltips) for the menu items can be activated in the options.

After calling up a function from the task area, a menu opens in the work area of the management software, sometimes with several sub-pages (tabs). An online help is available for these functions, which can be called up by pressing the **F1** key on the keyboard. An internet connection and a browser are required for opening the online help (pdf).

3.9.2 Management Software Toolbar

Some functions are only available if a connection to the Draco MV has been established (online mode). The respective functions are marked here with (online).

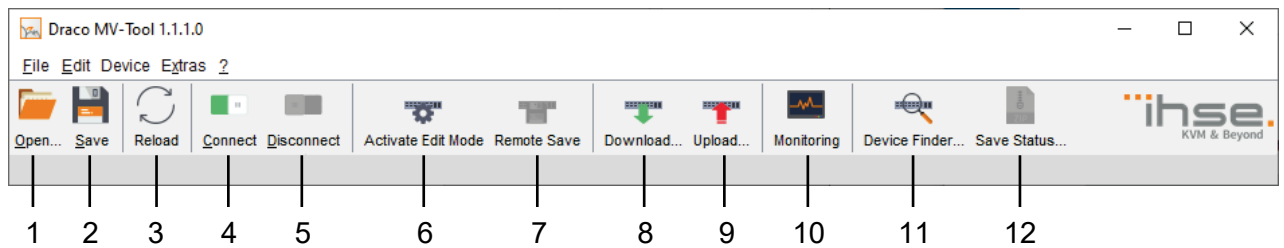

Fig. 22 Toolbar

- | | | | |
|---|--|----|--|
| 1 | Load local saved configuration | 8 | Show predefined configuration saved on Draco MV (online) |
| 2 | Save configuration local | 9 | Save predefined configuration on Draco MV (online) |
| 3 | Actualize configuration | 10 | Monitoring (online) |
| 4 | Connect to Draco MV, switches to online mode | 11 | Overview of devices in the subnet (online) |
| 5 | Disconnect from Draco MV, switches to offline mode | 12 | Save status local (online) |
| 6 | Edit mode | | |
| 7 | Save active configuration (online) | | |

3.9.3 Management Software Mouse Control

The following mouse commands are selectable for menu functions:

Mouse command	Function
Left mouse button	Menu selection, marking
Double-click left mouse button	Open function specific selection menus
Right mouse button	Open context specific selection menus

3.9.4 Management Software Keyboard Control

The following keyboard commands are available for the navigation and configuration within the menus:

Keyboard command	Function
<Cursor Left>	Cursor to the left
<Cursor Right>	Cursor to the right
<Cursor Up>	Line up
<Cursor Down>	Line down
<Page Up>	In input or status menus with more than one page: previous page
<Page Down>	In input or status menus with more than one page: next page
<Tab>	In input menus: previous field
<Left Shift> + <Tab>	In input menus: next field
<Space>	<ul style="list-style-type: none"> Switch in selection fields between two conditions (checkmark or not). Open already marked fields with editing or selecting possibility.

Keyboard command	Function
<Enter>	<ul style="list-style-type: none"> Select menu item In menus: Save data
<Ctrl> + <Tab>	<ul style="list-style-type: none"> Leave tables Jump from tables into the next field
<Ctrl> + <Left Shift> + <Tab>	<ul style="list-style-type: none"> Leave tables Jump from tables into the previous field



Various functions within the menus in the menu bar can be executed with the provided keyboard commands (e.g. press <Strg> + <S> to execute **Save**) that are listed to the right of the respective menu item.

3.9.5 Management Software Reload Options

The information shown in the management software can be reloaded in different ways:

- Press the <F5> key on the used keyboard.
- Click the **Reload** menu item in the toolbar.
- Click **Edit >Reload** in the drop-down menu of the menu bar.

3.9.6 Management Software Context Function

The management software offers several context functions that support user-friendly and effective operation. The context functions are described in the respective chapters.

Context function	Action	Results
Execute context function	Click with the right mouse button on a field.	A context menu opens and displays functions available for the corresponding field (if existing).
	Click with the left mouse button on the desired function.	The desired function will be executed.

3.9.7 Management Software Sort Function

Lists and tables in the management software offer a sorting function for fast and smooth search. An active filter is indicated by an arrow in the header.

Sort function	Action	Result
Ascending sort	Click with the left mouse button once on the header of the column to be sorted.	<ul style="list-style-type: none"> The column is sorted in ascending order. The sort status is indicated by an arrow pointing upwards.
Descending sort	Click with the left mouse button twice on the header of the column to be sorted.	<ul style="list-style-type: none"> The column is sorted in descending order. The sort is displayed by an arrow that points downwards.
Cancel sort	Click with the left mouse button once or twice on the head of the sorted column.	The arrow displayed disappears.

3.9.8 Management Software Filter Function

Lists and tables in the management software offer a filter function that supports a fast and smooth search. The filter entry field is located above the header. An active filter is indicated by a green filter symbol in the filter entry field.

Filter function	Action	Results
Activate filter	Click with the left mouse button in the filter entry field above the header. Write the word or part of a word to be filtered.	<ul style="list-style-type: none"> The filter results are shown immediately. The filter symbol is displayed in green.
Cancel filter	Delete the text in the filter entry field.	<ul style="list-style-type: none"> The list or table shows the complete content. The filter symbol is displayed in grey.

4 Installation

NOTICE

Please verify that interconnect cables, interfaces, and handling of the devices comply with the requirements (see chapter 8, page 109).



First-time users are recommended to set up the system in a test environment that is limited to a single room. This makes it easier to identify and solve any cabling problems, and experiment with your system more conveniently.

Requirements: Release of Network Ports

The following ports are used by the Draco MV depending on the configuration and have to be released at the security gateway, if necessary. The ports only will have to be released if you want to use the respective function.

Function	Port
DNS	53
SNTP	123 / UDP
SNMP	161/162 / both UDP
Syslog	514 / UDP
API	7055 / TCP (7065 for SSL)
Broadcast	7056 / UDP (7066 for SSL)

4.1 Connecting Draco MV to the Sink and the Sources



To achieve the best possible performance and results with the Draco MV system, we recommend using the supplied cables. If you need a replacement, please use the spare parts specified for this device, which can be found in the accessories list (see chapter 3.5, page 16).



To power up the system, the following sequence is recommended:
Monitor - Draco MV - source.

Connecting the Console

1. Connect the monitor to the video output (DisplayPort or HDMI) of the Draco MV.
2. Connect the USB-HID devices (e.g. keyboard and mouse) to the USB-HID port of the Draco MV.
3. Optional: connect the audio output of the Draco MV with suitable speakers or an audio amplifier.
4. Establish the power supply to the Draco MV.

Connecting the Draco MV

1. Connect up to four CPUs to the Draco MV with the supplied cables.
2. Connect audio-video connections of up to four CPUs to the audio / video inputs (DisplayPort or HDMI) of the Draco MV.
3. Start the system.

4.2 Setting Initial Configuration in the OSD

1. Open the OSD with the following keyboard command `<'Hot Key'>, <o>`.
2. Login with administrator rights in the main menu under **Configuration** (see chapter 5.1, page 40)
3. Configure initially as requested (see from chapter 5.3, from page 42).

4.3 Installing Management Software

Requirements

If you want to use the management software, the following requirements have to be fulfilled:

- Computer with an executable management software and an installed Java Runtime Environment (JRE, version 1.7 or higher)
- management software
- Available network connection between the management software and Draco MV.



Contact your system administrator concerning JRE and network connection.

Installing management software

The management software is available as a single executable program file that does not require a separate installation.

➔ Copy the program file to a directory on your computer of your choice.



If you do not have the program file, contact your dealer.

4.4 Connecting Draco MV to the Computer

NOTICE

For a connection between computer and Draco MV via switch or hub, a parallel assembled network cable is required.

Use only a network connection between computer and the Draco MV that is not primarily used for transmitting audio data.

➔ Connect the network cable to the RJ45 ports of computer and Draco MV.

4.5 Starting Management Software

- Open the management software by a double-click on the program icon or the file in the directory.

The management software starts in the offline mode.

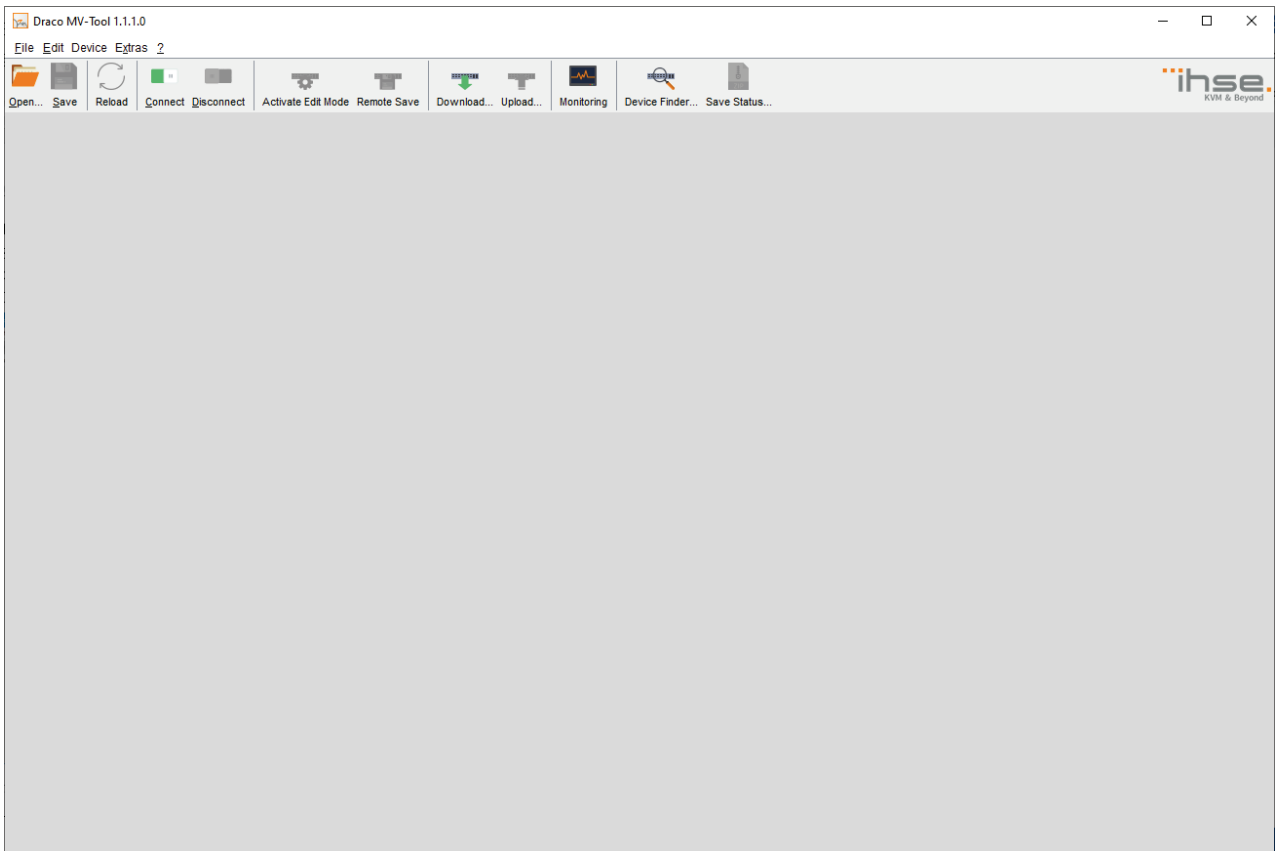

Fig. 23 Landing page in offline mode

4.6 Connecting Management Software with the Draco MV



At least FTP rights are required.

1. Click the **Connect** menu item in the tool bar.
An access window appears.
2. Enter the IP address according to the network configuration of the Draco MV (see chapter 5.3.3, page 44).
By default, the IP address of the Draco MV is 192.168.100.095 and DHCP is deactivated.
3. Enter the username and password of the administrator (see chapter 5.4, page 51).
4. Click the **Login** button to confirm your entries.

Connect

Hostname / IP Address 192.168.100.95

User admin

Password *****

Login Cancel

Fig. 24 Menu **Connect**



The data must be entered each time the network connection is re-established
Alternately, the data can be entered and stored in the management software under **Extras > Options** (see chapter 6.2.1, page 60).

4.7 Device Finder

The Device Finder offers the possibility to find all Draco MV that are in the same subnetwork. This is useful, for example, if the IP address of a specific Draco MV is unknown and should be accessed via IP.

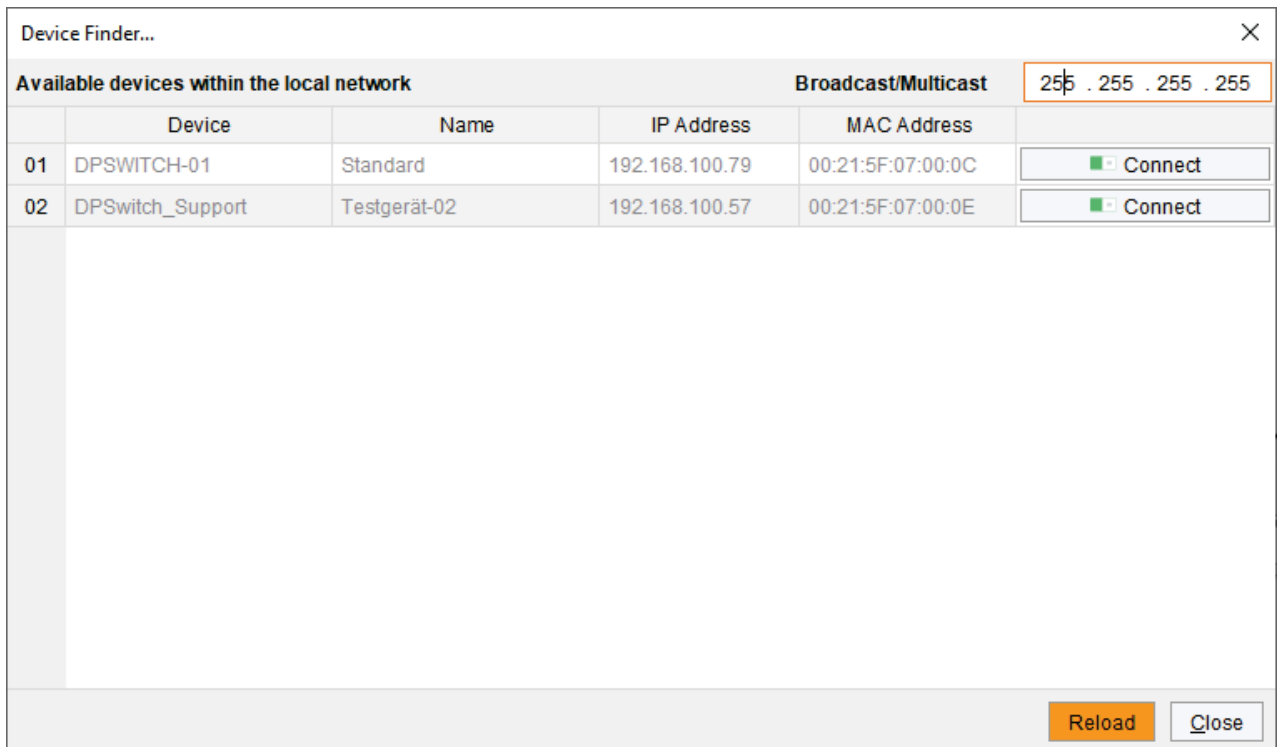

Fig. 25 Menu **Device Finder**

The following device information is shown in the Device Finder:

Information	Description
Device	Name of device
Name	Name of the active configuration
IP address	Current IP address of the device
MAC Address	MAC address of the device



The last column of the Device Finders can be used to access the respective Draco MV directly clicking the **Connect** button.

To start the Device Finder, proceed as follows:

- ➔ Select the **Device Finder** menu item in the toolbar.

5 Configuration via OSD

NOTICE

Possible loss of configuration changes

By clicking the **Okay** button, changes are overtaken to the active configuration and saved in the volatile memory of the Draco MV. In the event of a sudden power failure, these changes would be lost. To save changes permanently:

- save the changed configuration as an active (**Save**) or as a predefined configuration (**Save as...**) (from chapter 5.6, page 54) or perform a restart (see chapter 7.9.2, page 104).

NOTICE

A change in system-relevant parameters (e.g. change in the IP address) is immediately displayed in the OSD. To initialize system-relevant configuration changes on the Draco MV, the Draco MV must be restarted. The restart of the Draco MV may take several minutes, and the Draco MV is not available during the restart.

5.1 Log in to the OSD

Requirements:

- You have opened the OSD and you are in the main menu.

All configuration settings require a login with administrator rights.

➔ For administrator access to the configuration menu, log in with the following login data:

Field	Entry
User	admin
Password	admin

NOTICE

For security reasons, please change the administrator password as soon as possible (see chapter 5.4, page 51).

1. Press the **<F10>** key in the main menu of the OSD.

The login mask appears.

2. Enter the login data of the administrator.

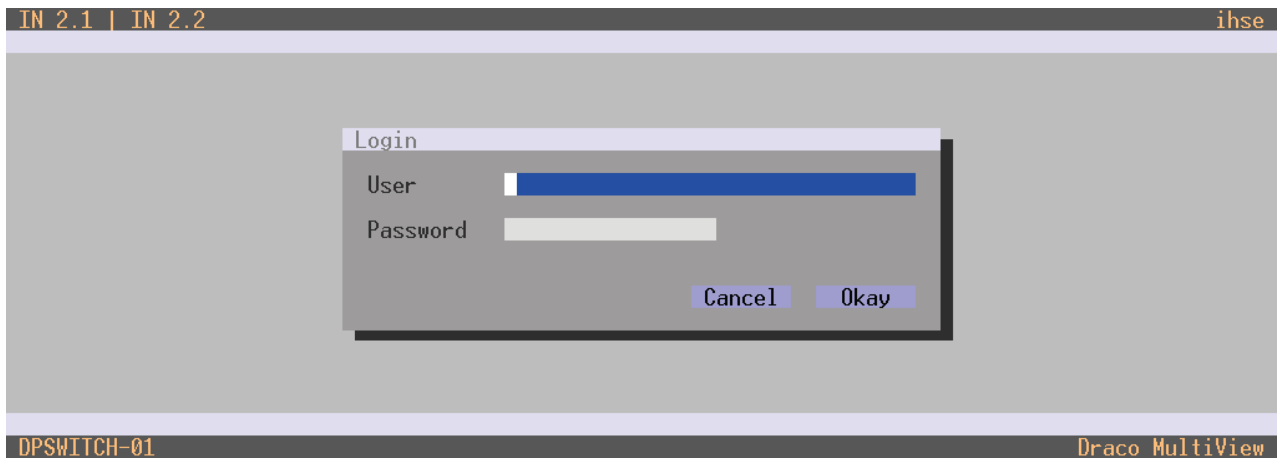

Fig. 26 Menu **Configuration - Login**

5.2 Log out of the OSD

- To log out a user, press the **<F10>** key again.

5.3 System Settings

Various options for system setting are available in the configuration menu. In addition, the options for saving, restarting, shutting down and resetting to factory settings are available in this menu.

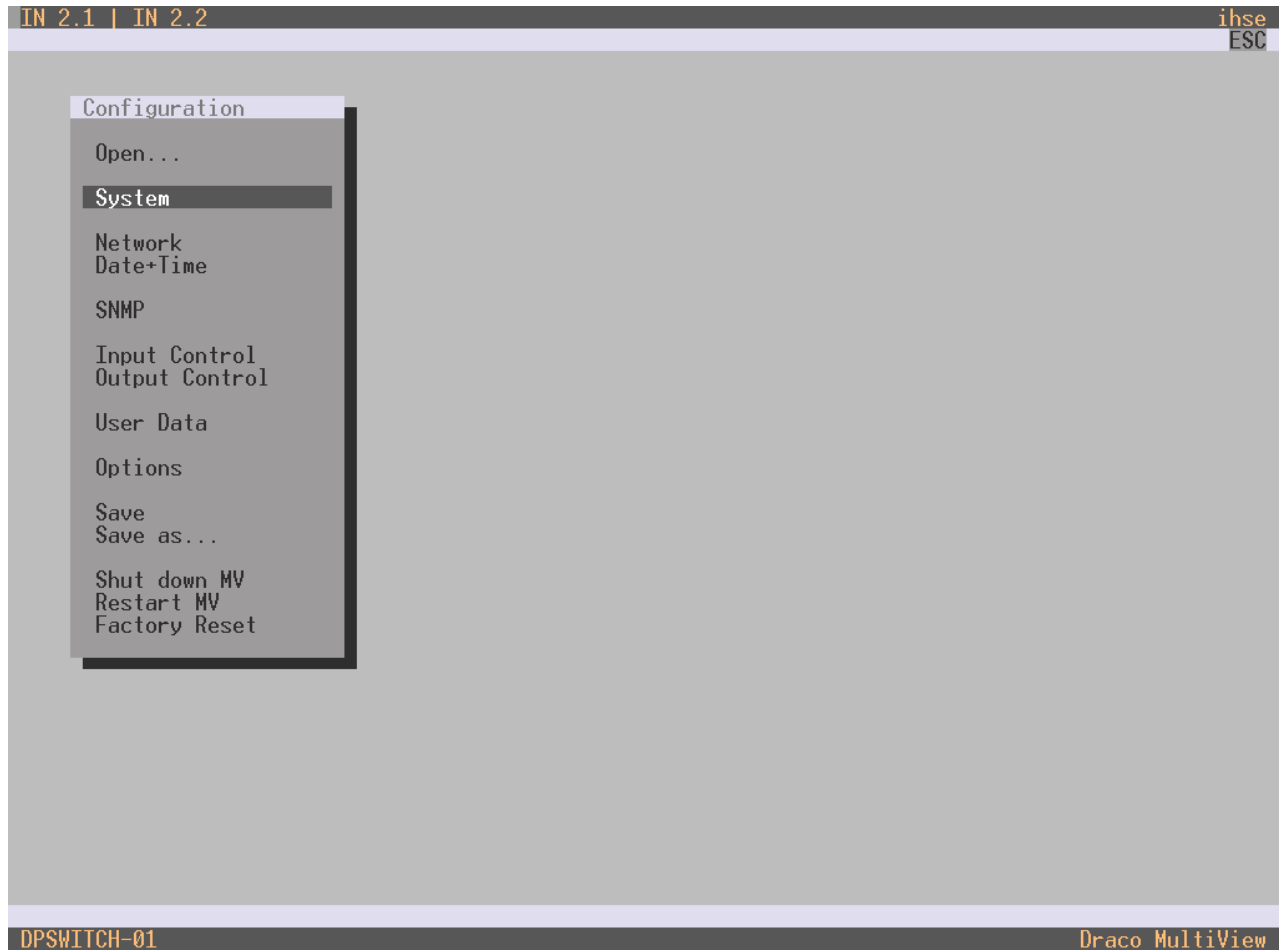

Fig. 27 Menu Configuration

5.3.1 Setting OSD Options

The OSD can be displayed transparently over the screen contents. The transparency is set in this menu.

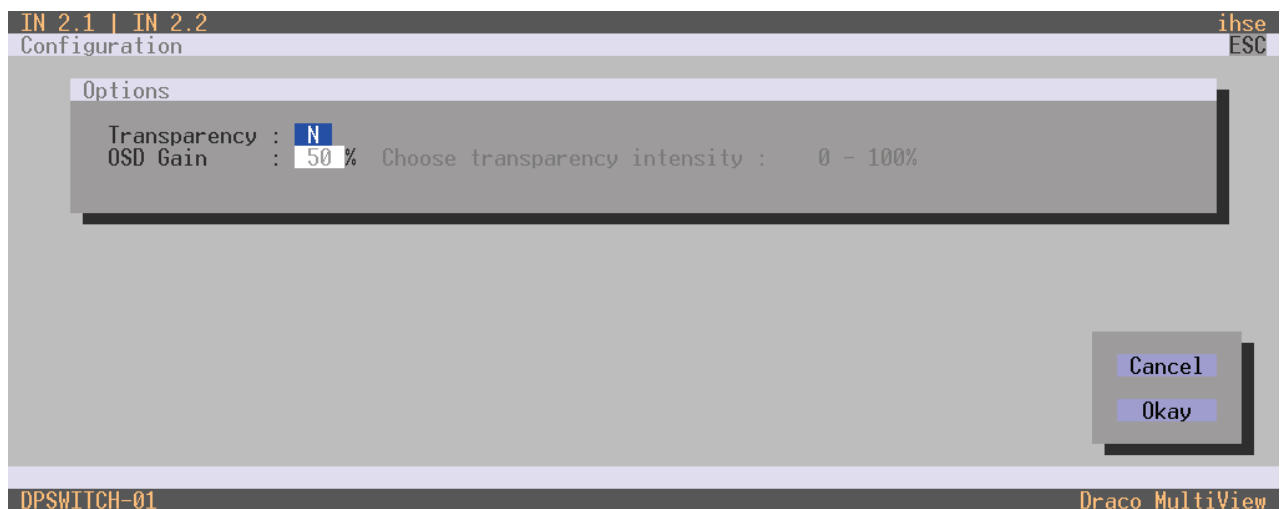

Fig. 28 Menu Configuration - Options

5.3.2 Setting System Configuration

The parameters for the system configuration are set in this menu:

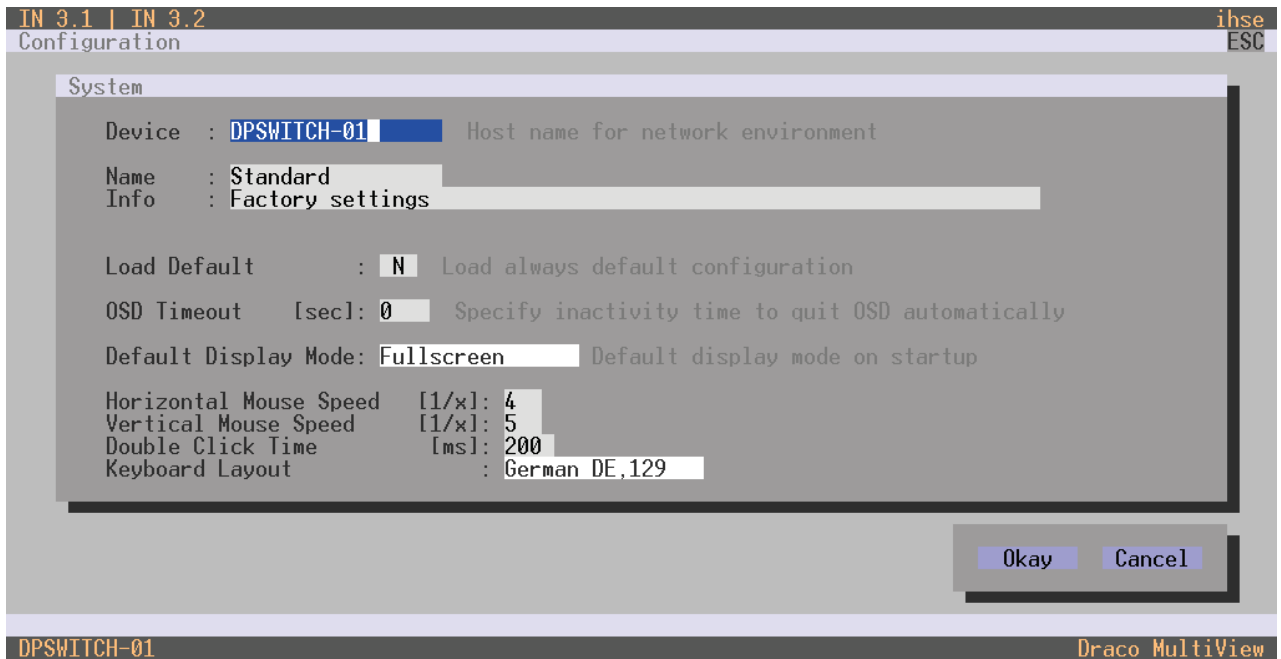

Fig. 29 Menu Configuration - System

The following parameters can be configured:

Field	Entry	Description
Device	Text	Enter the device name of the Draco MV (default: DPSWITCH-01)
Name	Text	Enter the name of the configuration that is used to save the current settings (default: Standard)
Info	Text	Additional text field to describe the configuration (default: Factory settings)
Load Default	Y	Starting the Draco MV after a restart or a switch-on with the default configuration.
	N	Starting the Draco MV after a restart or a switch-on with the last saved configuration (default).
OSD Timeout (sec)	0 to 999	Period of inactivity in OSD after which OSD will be closed automatically (default: 0 seconds). The OSD is not automatically ended at 0 seconds.
Default Display Mode	List	Starting the Draco MV after a restart or a switch-on with the default display mode
Horizontal Mouse Speed [1/x]	1 to 9	Adjustment of the horizontal mouse speed, 1 = slow, 9 = fast (default: 4)
Vertical Mouse Speed [1/x]	1 to 9	Adjustment of the vertical mouse speed, 1 = slow, 9 = fast (default: 5)
Double Click Time [ms]	100 to 800	Adjustment of the time slot for a double-click (default: 200)
Keyboard Layout	Region	Set the OSD keyboard layout according to the keyboard used (default: German (DE))

To set the parameters for the system configuration, proceed as follows:

1. Select **Configuration > System** in the main menu.
2. Modify the desired settings.
3. Click the **Okay** button to confirm your entries.

5.3.3 Setting Network Configuration

NOTICE

To activate the modified network parameters a restart of the Draco MV has to be performed.

NOTICE

If the syslog function is activated, the logging will be started after restarting the Draco MV.

The parameters for the network configuration are set in this menu.



Fig. 30 Menu Configuration - Network

The following parameters can be configured:

Network Interface

Field	Entry	Description
DHCP	Y	The network settings are automatically supplied by a DNS server Note: If DHCP is activated and there is no physical network connection available, the boot times might increase.
	N	Function not active (default)
IP Address	Byte	Input of the IP address, if DHCP is not active (default: 192.168.100.95)
Subnet Mask	Byte	Input of the subnet mask in the form "255.255.255.0", if DHCP is not active (default: 255.255.255.0)
Gateway	Byte	Input of the subnet mask in the form "192.168.1.1", if DHCP is not active
Multicast	Byte	Input of the multicast address, if using within a multicast group (default: 255.255.255.255)

Network Services

Field	Entry	Description
API Service	Y	LAN interface at the Draco MV activated for access via management software (API service port 7055)
	N	Function not active (default)
SSL	Y	Activate SSL encryption for API, management software API, management software and Draco MV communication
	N	Function not active (default)
Syslog #1/#2	Y	Syslog server for status request is active
	N	Function not active (default)
Syslog Server #1/#2	Byte	Input of the IP address of the syslog servers in the form "192.168.1.1" and of the syslog port (default: 514)

Log Levels

Field	Entry	Description
Trace	DEB	Activate debug messages in trace (default: N) Note: The debug messages are exclusively for Draco MV diagnostics. Use this function only for concrete debug cases as it is not intended for normal operation.
	INF	Activate information messages in trace (default: N)
	NOT	Activate notification messages in trace (default: Y)
	WAR	Activate warning messages in trace (default: Y)
	ERR	Activate error messages in trace (default: Y)
Syslog #1/#2	DEB	Activate debug messages in trace (default: N) Note: The debug messages are exclusively for Draco MV diagnostics. Use this function only for concrete debug cases as it is not intended for normal operation.
	INF	Activate information messages in trace (default: N)
	NOT	Activate notification messages in trace (default: Y)
	WAR	Activate warning messages in trace (default: Y)
	ERR	Activate error messages in trace (default: Y)

To set parameters for the network configuration, proceed as follows:

1. Select **Configuration > Network** in the main menu.
2. Modify the desired settings.
3. Click the **Okay** button to confirm your entries.

5.3.4 Setting Date and Time

The parameters for the system configuration are set in this menu, based on Simple Network Time Protocol (SNTP):

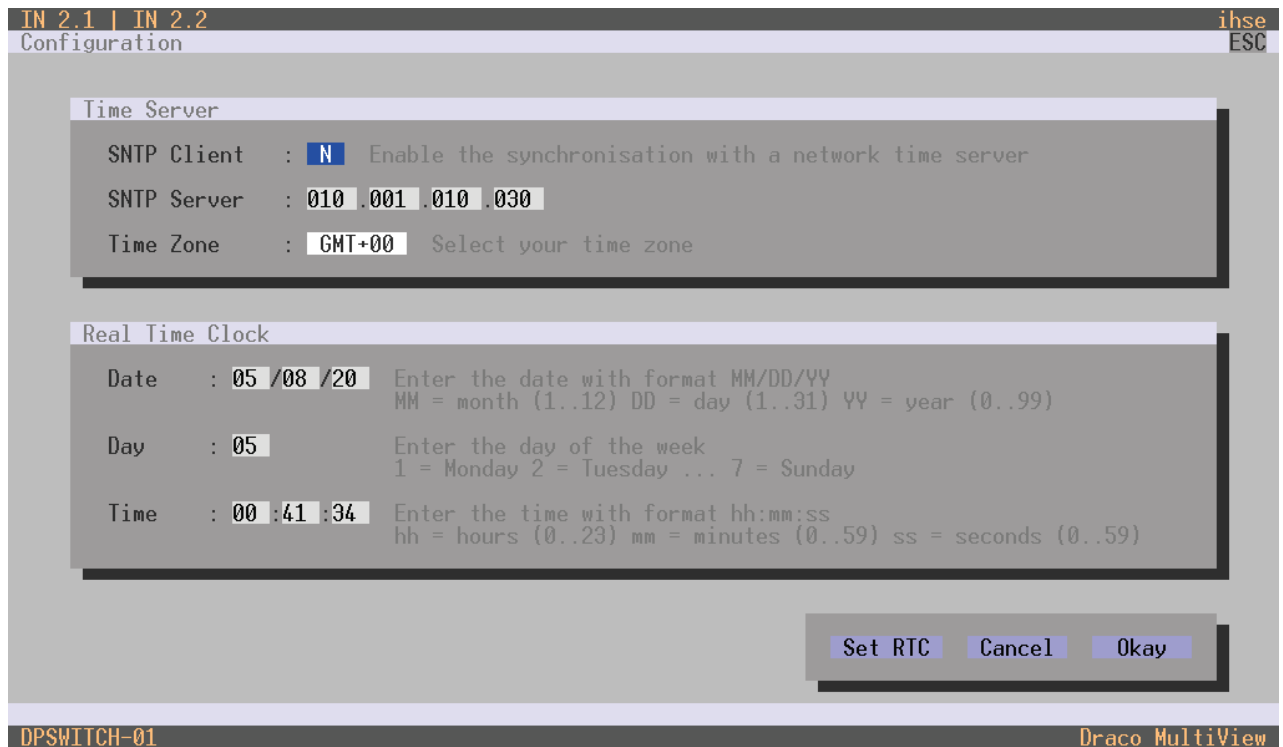

Fig. 31 Menu Configuration - Date+Time

The following parameters can be configured:

Time Server

Field	Entry	Description
SNTP Client	Y	Enable network time server synchronization
	N	Function not active (default)
SNTP Server	Byte	Input of the SNTP server IP address (default: 000.000.000.000)
Time Zone	Region	Set your specific time zone (default: GMT + 00)

Real Time Clock

Field	Entry	Description
Date*	MM	1 to 31
	DD	1 to 31
	YY	1 to 99
Day	1 to 7	Enter day of the week
Time	hh	0 to 23
	mm	0 to 59
	dd	0 to 59

* Date format according to the English notation.

Configuring the time server

To configure a time server, proceed as follows:

1. Select **Configuration > Date+Time** in the main menu.
2. Set the SNTP Client option to Y (Yes).
3. Enter the IP address of your SNTP server in the **SNTP Server** field.
4. Select your time zone in the **Time Zone** field.
5. Click the **Okay** button to confirm your settings.
6. Restart the Draco MV. The system time will be now provided by the SNTP server.

Configuring the real time clock without time server

To set the real time clock without using SNTP, proceed as follows:

1. Select **Configuration > Date+Time** in the main menu.
2. Set the current date in the **Date** field
3. Set the current Day in the **Day** field.
4. Set the current time in the **Time** field.
5. Click the **RTC** button to confirm your settings.

The real time clock will be now provided.

5.3.5 Setting SNMP Function

The SNMP function allows all function-critical and safety-critical elements of the Draco MV to be monitored and queried. This function complies with the RFC 1157 conformal standard.

NOTICE

When using SNMP monitoring, for reasons of access security, the use of a dedicated network according to the IT-Grundschutz catalog is recommended. The read only community for the MIB file is **draco**.

NOTICE

For an activation of the SNMP agent function or the SNMP server function, a restart of the Draco MV is necessary. Two SNMP servers can be used at the same time.

The settings for the SNMP monitoring are set in this menu:



Fig. 32 Menu Configuration - SNMP

SNMP Agent

You can activate the SNMP agent by setting Y (Yes):

Traps	Description
Enable	Permission for an active query of the SNMP agent for traps is granted.

SNMP Server

You can activate the following traps by setting Y (Yes):

Traps	Description
Enable Traps	Activation of the monitoring via traps
Server Address	Input of the IP address of the SNMP server in the form "192.168.1.1" and of the SNMP port (default server 1: 161, default server 2: 162)
Status	Notification about Draco MV status
Power Supply #1	Notification about the status of power supply unit #1
Power Supply #2	Notification about the status of power supply unit #2
Switch Command	Notification about a performed switching operation at the Draco MV
Insert Output	<ul style="list-style-type: none"> Notification about a newly connected to the Draco MV Notification about a switched-on console
Remove Output	<ul style="list-style-type: none"> Notification about a removed console from the Draco MV Notification about a switched off console
Input Video Info	Notification about a change of resolution or change of frequency
EDID Change	Notification about a change in EDID information at the inputs

Activating the SNMP agent

To activate the SNMP agent, proceed as follows:

1. Select **Configuration > SNMP** in the main menu.
2. Set the **Enable** option to **Y (Yes)** within **SNMP Agent**.

By activating this option, the permission for an active query of the SNMP agent is granted.

Configuring a SNMP server

To configure a SNMP server, proceed as follows:

1. Set the **Enable Traps** option to **Y (Yes)** within **SNMP Server**.
This function allows an active transmission of trap messages from the SNMP agent to the SNMP server.
2. Set the IP address of the SNMP server within **Server Address**.
3. Activate the requested traps by enabling them to **Y (Yes)**.

5.4 User Settings

Two users are set by default. It is not intended to create further users.

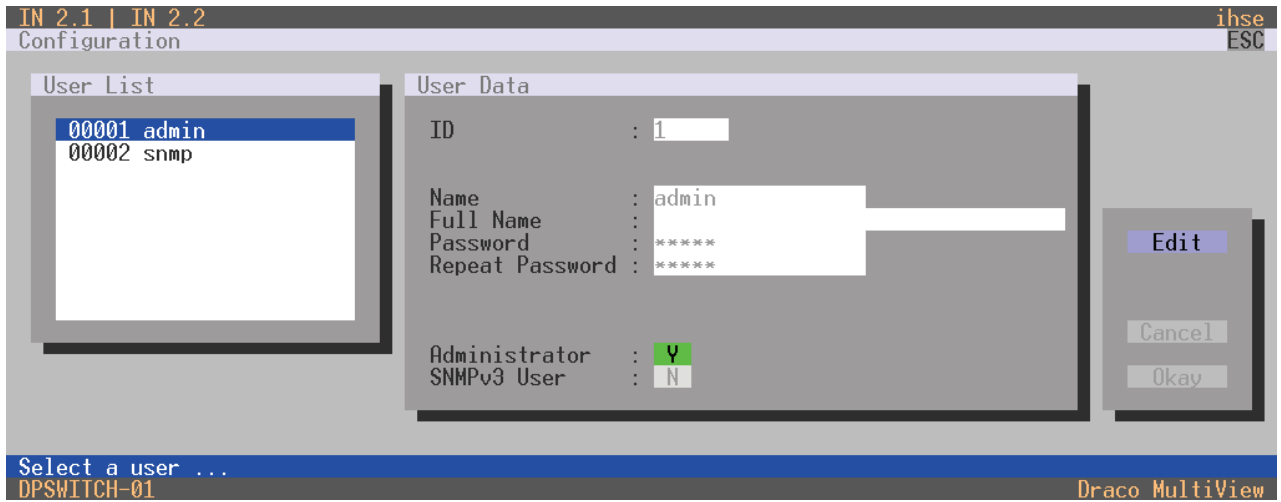

Fig. 33 Menu Configuration - User Data

Administrator

The administrator has the permission to configure the system. The following parameters can be configured for the administrator:

Field	Entry	Description
Full Name	Text	Optional: personal username (case sensitive) Note: A personal username can consist of up to 32 characters.
Password	Text	User password (case sensitive)
Repeat Password	Text	Repeat user password (case sensitive)

SNMPv3 user

The SNMPv3 user has the permission to enable encrypted SNMPv3. The following parameters can be configured for the SNMPv3 user:

Field	Entry	Description
Full Name	Text	Optional: personal username (case sensitive) Note: A personal username can consist of up to 32 characters.
Password	Text	User password (case sensitive)
Repeat Password	Text	Repeat user password (case sensitive)
SNMPv3 User	Y/N	Y = Permission to use SNMPv3 (encrypted)

Editing user settings

To edit settings of an existent user, proceed as follows:

1. Select **Configuration > User Data** in the main menu.
2. Select a user in the **User List**.
3. Click the **Edit** button to open the edit mode.
4. Modify the desired settings.
5. Click the **Okay** button to confirm your entries.

5.5 Setting Video Inputs and Video Outputs

5.5.1 Setting Video Inputs Parameters

The parameters for the video inputs are set in this menu:

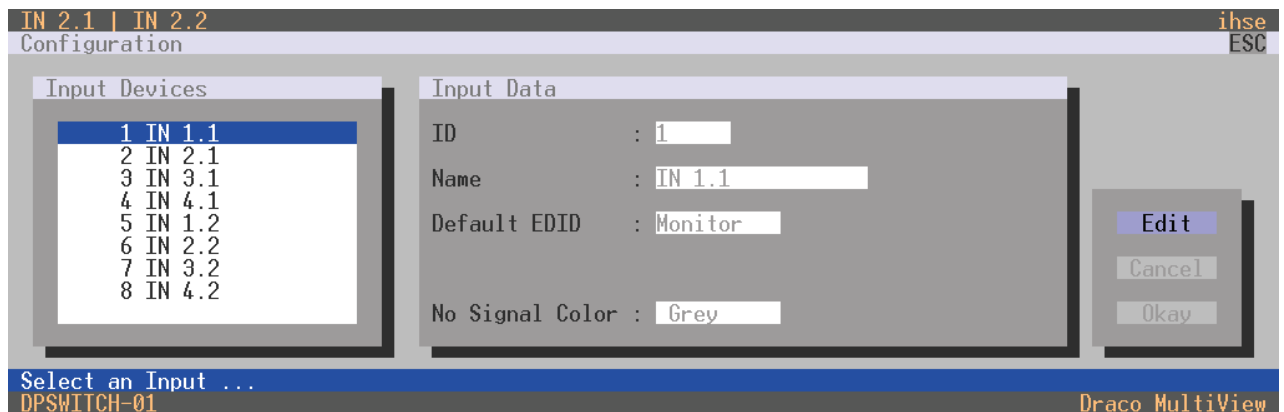

Fig. 34 Menu **Configuration - Input Control**

The following parameters can be configured:

Field	Entry	Description
Name	Text	Optional: Individual name for video inputs (case sensitive) Note: An individual name can consist of up to 32 characters.
Default EDID	List	MONITOR When the Draco MV is restarted or a monitor is plugged in during operation, the monitor's EDID is read out and transmitted to the CPU inputs. The video signal is always displayed with the resolution of the monitor.
		1080p60 When the Draco MV is restarted or a monitor is plugged in during operation, the video signal is always displayed with the preset resolution.
		4K30 4K60
No Signal Color	List	Background color if no video signal is available



Using the fullscreen display mode:

If there is no video signal input, a notification is displayed: NO SYNC OR SIGNAL.

To configure the settings for a video input, proceed as follows:

1. Select **Configuration > Input Control** in the main menu.
2. Select the video input to be configured in the list **Input Devices**.
3. Click the **Edit** button to open the edit mode.
4. Modify the desired settings.
5. Click the **Edit** button to confirm your entries.

5.5.2 Setting Video Outputs Parameters

The parameters for the video outputs are set in this menu:

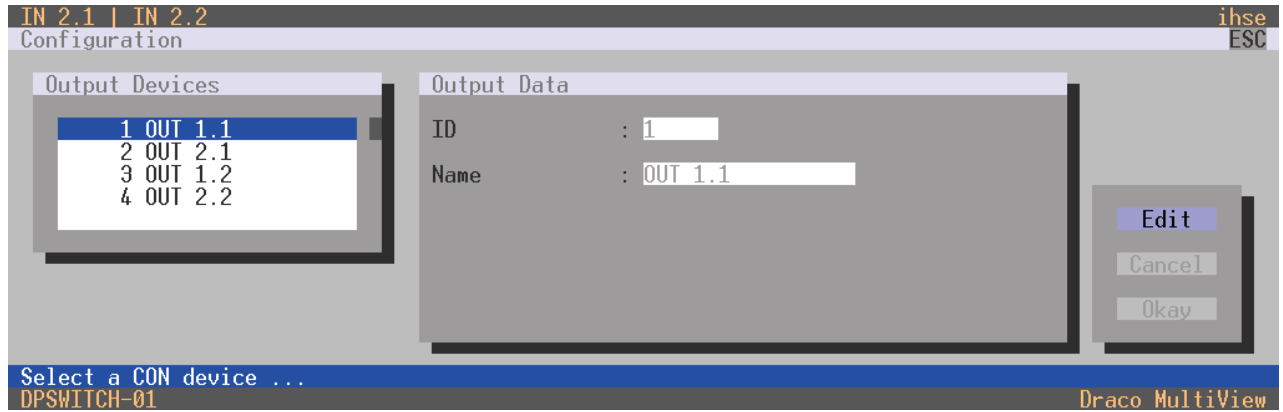

Fig. 35 Menu Configuration - Output Control

The following parameters can be configured:

Field	Entry	Description
Name	Text	Optional: Individual name for video outputs (case sensitive) Note: An individual name can consist of up to 32 characters.

To configure the name of a video output, proceed as follows:

1. Select **Configuration > Input Control** in the main menu.
2. Select the video output to be configured in the list **Output Devices** list.
3. Click the **Edit** button to open the edit mode.
4. Modify the name of the video output.
5. Click the **Okay** button to confirm your entries.

5.6 Saving and Loading Configuration

NOTICE

By default, the last configuration that has been saved in the permanent Draco MV memory will be restored after a restart of the Draco MV.

First starting the Draco MV, the factory configuration will be copied in the current configuration. You have 2 possibilities to save save configuration changes:

- saving the current configuration permanently in the Draco MV memory or
- saving the configuration in up to 8 predefined storage locations, as well as the default configuration in the memory of the Draco MV

5.6.1 Saving Active Configuration

NOTICE

Changing or saving configurations blocks the Draco MV memory and leads to a freeze of all OSD menus for a few seconds. The switching connections are not affected by this freeze.

To save the current configuration permanently in the Draco MV storage, proceed as follows:

➔ Select **Configuration > Save** in the main menu.

The current configuration of the Draco MV is permanently saved to the Draco MV memory.

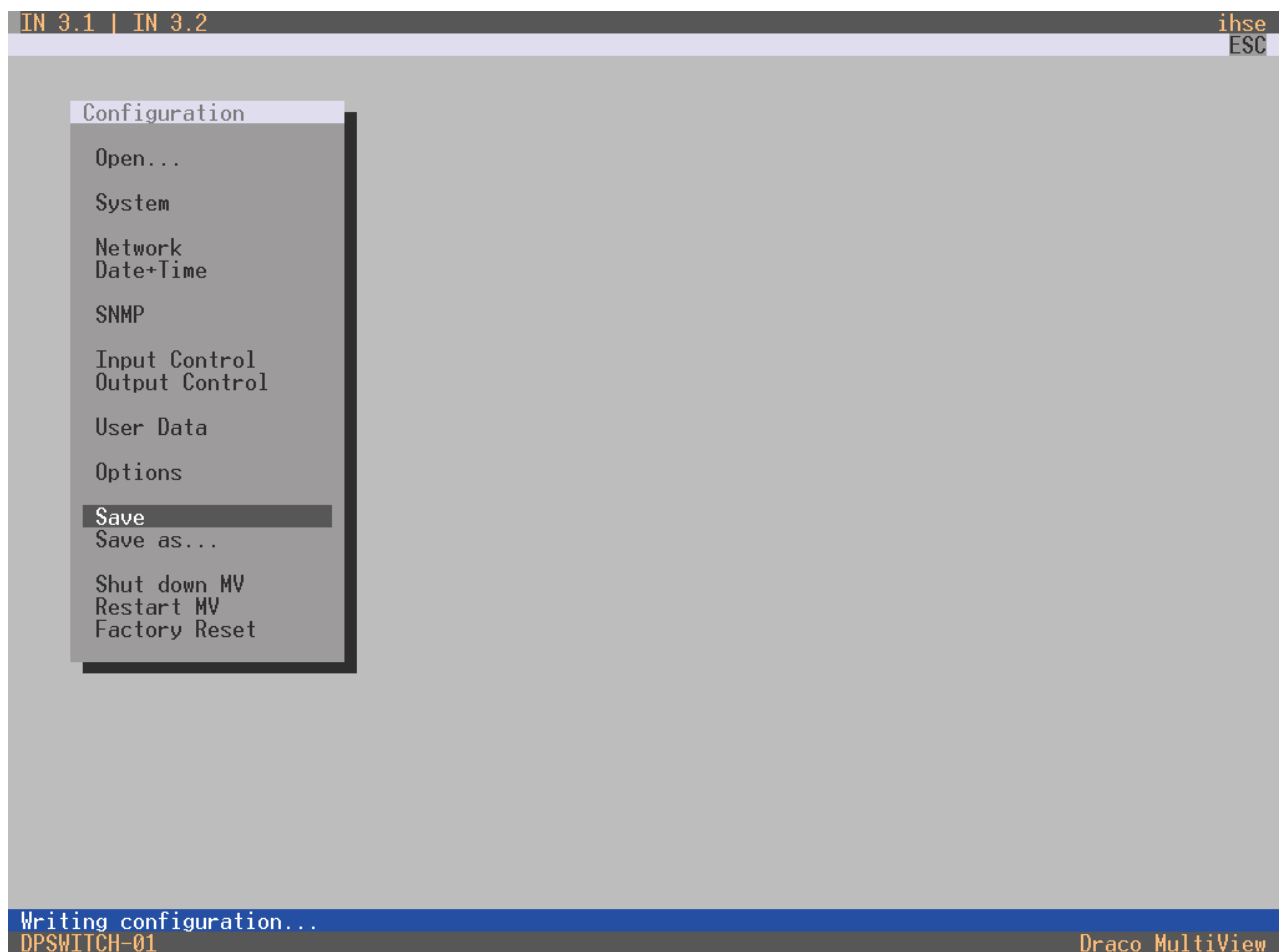

Fig. 36 Menu **Configuration - Save**

5.6.2 Saving Predefined Configuration

In this menu the current configuration can be saved in up to eight different memory locations in the memory of the Draco MV. However, it does not replace the buffering of configuration (see chapter 5.6.1, page 54).

Additionally, a default configuration can be saved that can be loaded as default configuration for each start of the Draco MV (see chapter 5.3.2, page 43).

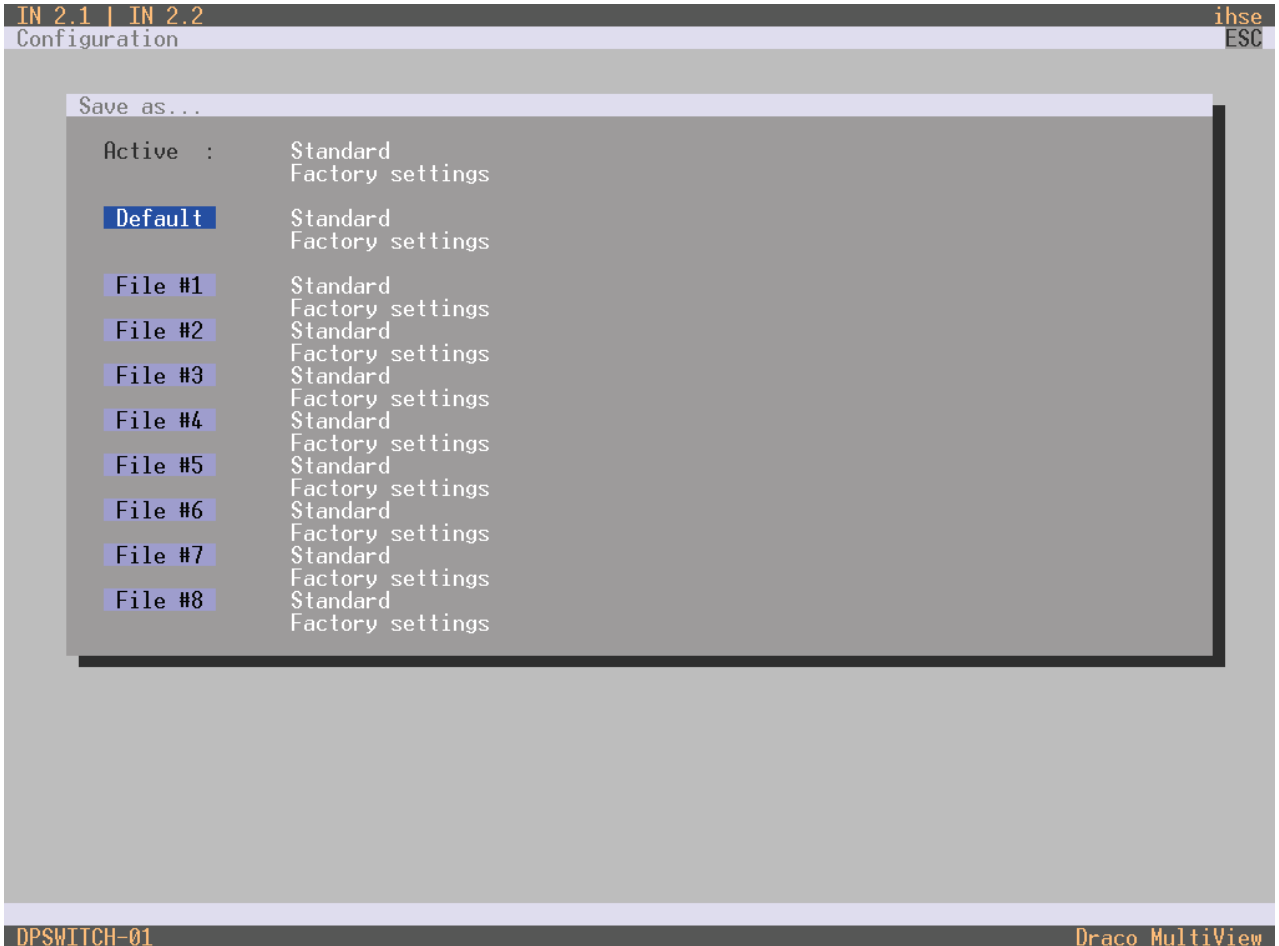

Fig. 37 Menu Configuration - Save as...

Saving position	Name and detailed information
Active	Name and detailed information of the current configuration are shown. This configuration can be saved.
Default	Name and detailed information of the respective saved configuration are shown. This storage location can be overwritten.
File #1 to File #8	Name and detailed information of the respective saved configuration are shown. These storage locations can be overwritten.

To save the created configuration to a specific memory location, proceed as follows:

1. Select **Configuration > Save As...** in the main menu.
2. Select the required storage location (**File #1** to **File #8**) or **Default**.

The current configuration will be saved to this storage location and will be shown immediately in the menu. The previously saved configuration saved to this storage location is deleted.

5.6.3 Load Predefined Configuration

Previously saved configurations are loaded in this menu. In **Active**, the currently loaded configuration is displayed. To replace the current configuration through another configuration, in addition to the default configuration (**Default**), one from up to eight further, personalized configurations (**File #1** to **File #8**) can be loaded.

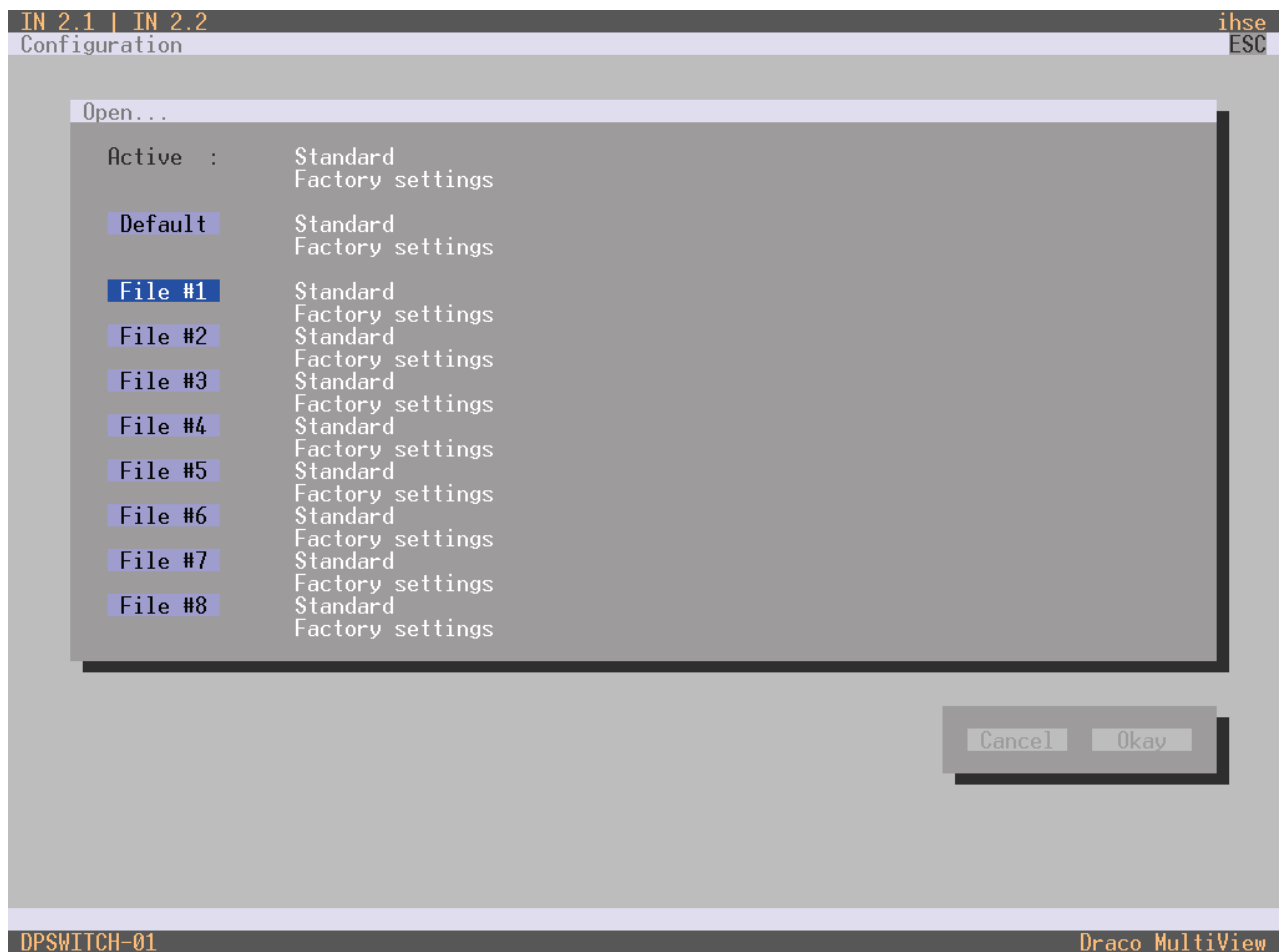

Fig. 38 Menu **Configuration - Open...**

To load a previously saved configuration, proceed as follows:

1. Select **Configuration > Open** in the main menu.
2. Select the desired configuration.
3. Click the **Okay** button to load the selected configuration.

The selected configuration is immediately loaded and displayed in the menu as **Active**. The previously active configuration is overwritten.

6 Configuration via Management Software

NOTICE

Possible loss of changes

By clicking the **Apply** button changes are overtaken to the active configuration and saved in the volatile memory of the Draco MV. In the event of a sudden power failure, these changes would be lost. To save changes permanently:

- save the changed configuration as an active (**Save**) or as a predefined configuration (**Save as...**) (see from chapter 6.6, page 80) or perform a restart (see from chapter 7.10.2, page 107).

NOTICE

A change in system-relevant parameters (e.g. change in the IP address) is immediately displayed in the management software. To initialize system-relevant configuration changes on the Draco MV, the Draco MV must be restarted. The restart of the Draco MV may take several minutes, and the Draco MV is not available during the restart.



You have two possibilities to configure the Draco MV. All configuration options described in the following chapters can be carried out in online mode. Information on how to proceed in offline mode is described on the following page.

Online Mode:

Configurations and system settings can be edited via management software in online mode with an active connection between Draco MV and management software. Hereby, the following steps are necessary:

1. Connect the management software with the Draco MV.
The manufacturer-specific configuration (Factory Setting) saved on the Draco MV) is loaded into management software.
2. Activate edit mode
3. Configure system settings and confirm changes.
4. Deactivate edit mode.
5. Save configuration.
6. Restart the system.

Offline Mode

Configuration and system settings via management software can be changed in offline mode without a direct connection between Draco MV and management software. Afterwards, the configuration has to be uploaded to the Draco MV. Hereby, the following steps are necessary:

1. Connect the management software with the Draco MV.
The manufacturer-specific configuration (Factory Setting) saved on the Draco MV) is loaded into management software.
2. Download configuration.
3. Close connection from the management software to the Draco MV.
4. Activate edit mode.
5. Configure system settings and confirm changes.
6. Deactivate edit mode.
7. Upload configuration to the Draco MV and activate immediately (optional) or later.
8. Optionally: restart the system.

6.1 Configuring System

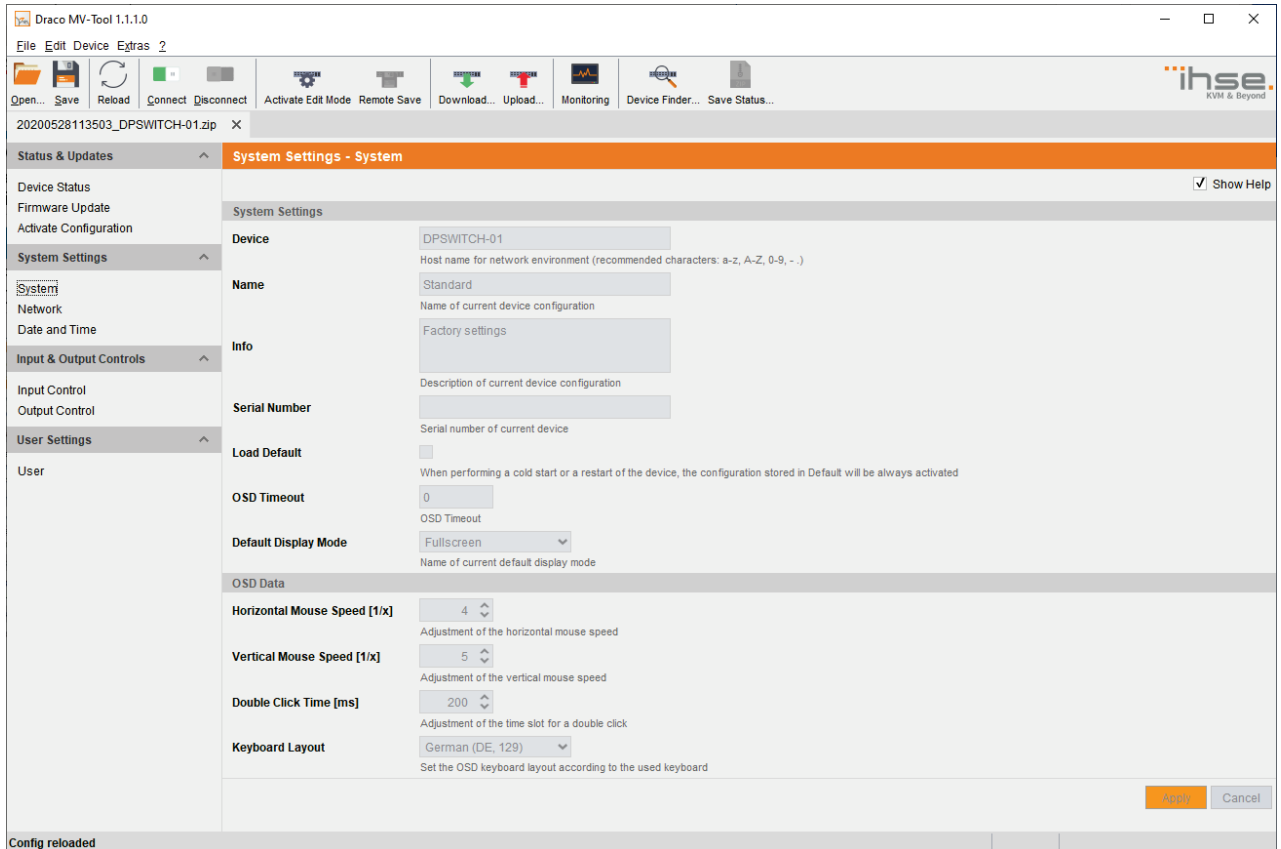

Fig. 39 Menu **System Settings - System**

To edit a configuration, proceed as follows:

1. Select the **Device > Activate Edit Mode** menu item in the toolbar.
The edit mode will open. A symbol is shown in the status bar.
2. Make any edits at the configuration and system settings.
3. Click the **Apply** button to confirm the changes.

The changes will apply immediately as current configuration in the volatile memory of the Draco MV.

To deactivate the edit mode, proceed as follows:

- ➔ Select the menu item **Device > Deactivate Edit Mode** in the menu bar.

6.2 Setting Management Software Options

The settings of the management software can be customized and optimized to support you configure your Draco MV. The settings can be set in the offline mode.

6.2.1 Setting Program Default Settings

Data that must be entered again and again when using the management software can be stored in the default settings.

Fig. 40 Menu **Extras** - **Options** - **Default Settings**

The following parameters can be configured:

Option	Description
IP / Hostname	Default IP address or host name of the Draco MV for establishing a connection
User	Default username for establishing a connection
Configuration Directory	Default directory for configuration files
Firmware Directory	Default directory for update files
Status Directory	Default directory for the firmware status
Import / Export Directory	Default IP address of the Draco MV required for connection

To activate or set the default settings, proceed as follows:

1. Select **Extras > Options** in the menu bar.
The **Options** menu will open showing the **Default Settings** tab.
2. Enter the appropriate data.
3. Click the **Apply** button to confirm your entries.

6.2.2 Setting Font Size and Tooltip in the Toolbar

The font size can be set in this menu and the display of tooltips for the toolbar can be activated.

1. Select the **Style** tab.
2. Select the desired font size.
3. Click the **Show Toolbar Button Text** checkbox.

A tooltip is displayed when hovering over a menu item in the toolbar.

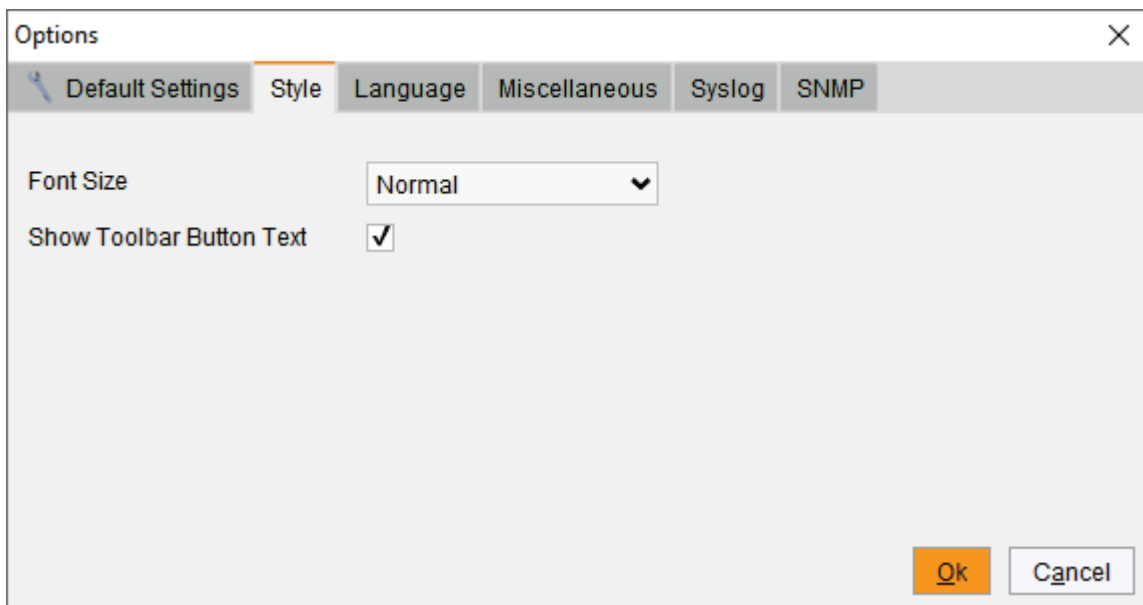

Fig. 41 Menu **Extras** - **Options** - **Style**

6.2.3 Setting Language of the Management Software

The language within the management software is set in this menu. The charset must match the selected language to ensure correct representation.

1. Select the tab **Language**.
2. Select the desired language within the management software and the corresponding charset.

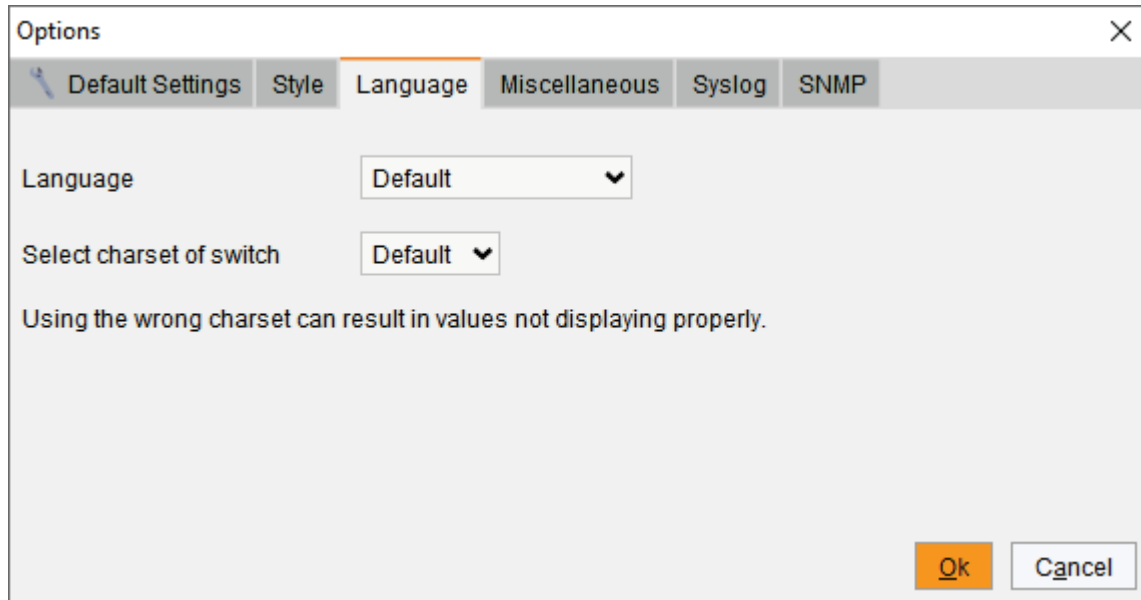

Fig. 42 Menu **Extras** - **Options** - **Language**

6.2.4 Setting Autostart of the Device Finder

To start the device finder automatically when starting the management software, proceed as follows:

1. Select the tab **Miscellaneous**.
2. Activate the checkbox **Device Finder on startup**.

After restarting the Draco MV, the device finder appears.

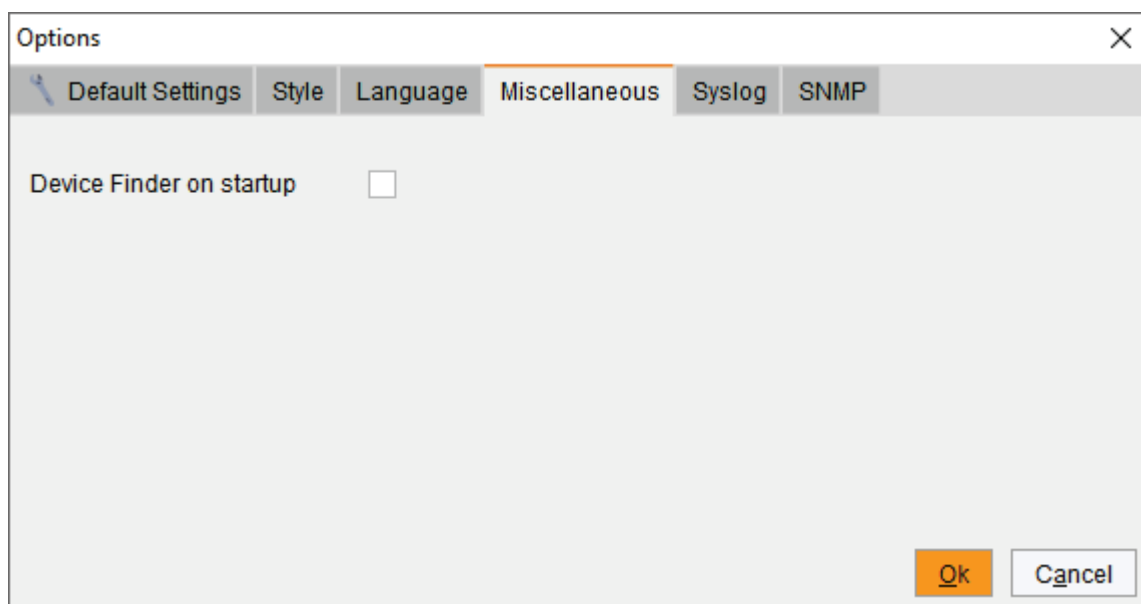

Fig. 43 Menu **Extras** - **Options** - **Miscellaneous**

6.3 System Settings

6.3.1 Setting System Configuration

The parameters for the system configuration are set in this menu.

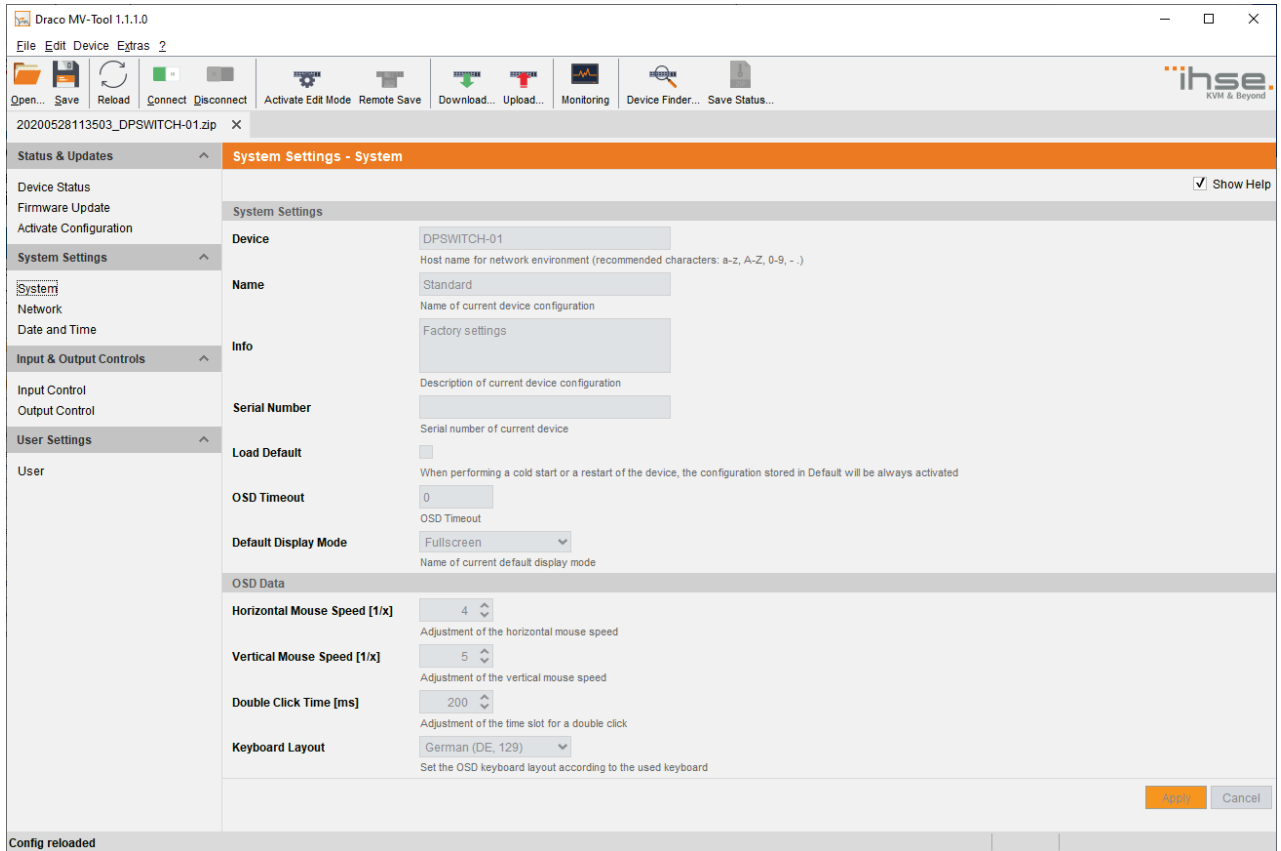

Fig. 44 Menu System Settings - System

The following parameters can be configured:

System Settings

Parameter	Entry	Description
Device	Text	Enter the device name of the Draco MV (default: DPSWITCH-01)
Name	Text	Enter the name of the configuration that is used to save the current settings (default: Standard)
Info	Text	Additional text field to describe the configuration (default: Factory settings)
Serial Number	Numeric	Serial number of the current device

Parameter	Entry	Description
Load Default	Y	Starting the Draco MV after a restart or a switch-on with the default configuration.
	N	Starting the Draco MV after a restart or a switch-on with the last saved configuration (default).
OSD Timeout (sec)	0 to 999	Period of inactivity in OSD after which OSD will be closed automatically (default: 0 seconds). The OSD is not automatically ended at 0 seconds.
Default Display Mode	List	Starting the Draco MV after a restart or a switch-on with the default display mode

OSD Data

Parameter	Entry	Description
Horizontal Mouse Speed [1/x]	1 to 9	Adjustment of the horizontal mouse speed, 1 = slow, 9 = fast (default: 4)
Vertical mouse speed [1/x]	1 to 9	Adjustment of the vertical mouse speed, 1 = slow, 9 = fast (default: 5)
Double Click Time [ms]	100 to 800	Adjustment of the time slot for a double-click (default: 200)
Keyboard Layout	Region	Set the OSD keyboard layout according to the keyboard used (default: German (DE))

To set parameters for the system configuration, proceed as follows:

1. Select **Configuration > System** in the main menu.
2. Modify the desired settings.
3. Click the **Apply** button to confirm your entries.

6.3.2 Setting Network Configuration

The parameters for the network configuration are set in this menu.

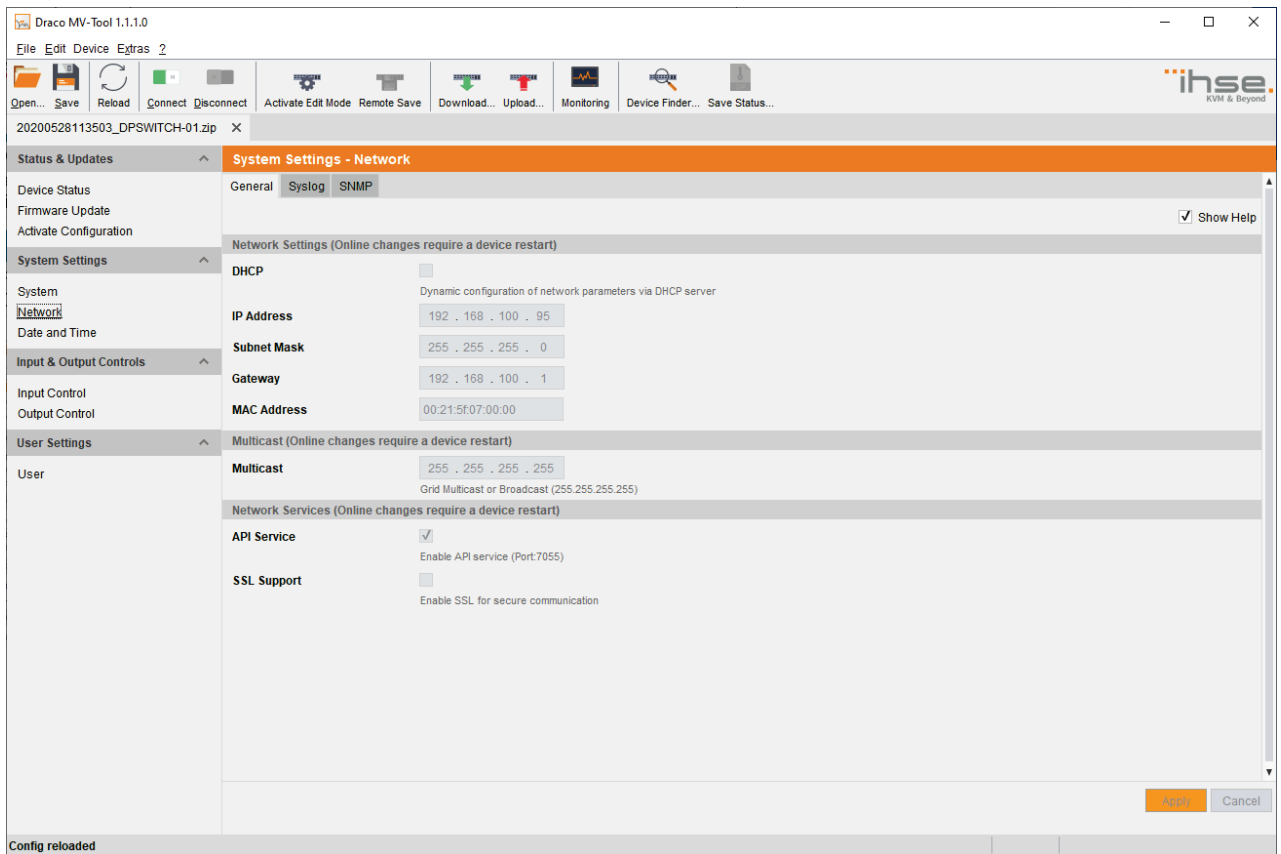

Fig. 45 Menu System Settings - Network - General

The following parameters can be configured:

Network Settings

Field	Entry	Description
DHCP	Y	The network settings are automatically supplied by a DNS server Note: If DHCP is activated and there is no physical network connection available, the boot times might increase.
	N	Function not active (default)
IP Address	Byte	Input of the IP address, if DHCP is not active (default: 192.168.100.95)
Subnet Mask	Byte	Input of the subnet mask in the form "255.255.255.0", if DHCP is not active (default: 255.255.255.0)
Gateway	Byte	Input of the subnet mask in the form "192.168.1.1", if DHCP is not active
MAC Address	Byte	Cannot be changed, is called up automatically

Multicast

Field	Entry	Description
Multicast	Byte	Input of the multicast address, if using within a multicast group (default: 255.255.255.255)

Network Services

Field	Entry	Description
API Service	Y	LAN interface at the Draco MV activated for access via management software (API service port 7055)
	N	Function not active (default)
SSL Support	Y	Activate SSL encryption for API, management software API, management software and Draco MV communication
	N	Function not active (default)

To set parameters for the network configuration, proceed as follows:

1. Select **Configuration > Network** in the task area.
2. Modify the desired settings.
3. Click the **Apply** button to confirm your entries.

6.3.3 Setting Syslog Function

The parameters for the syslog function are set in this menu:

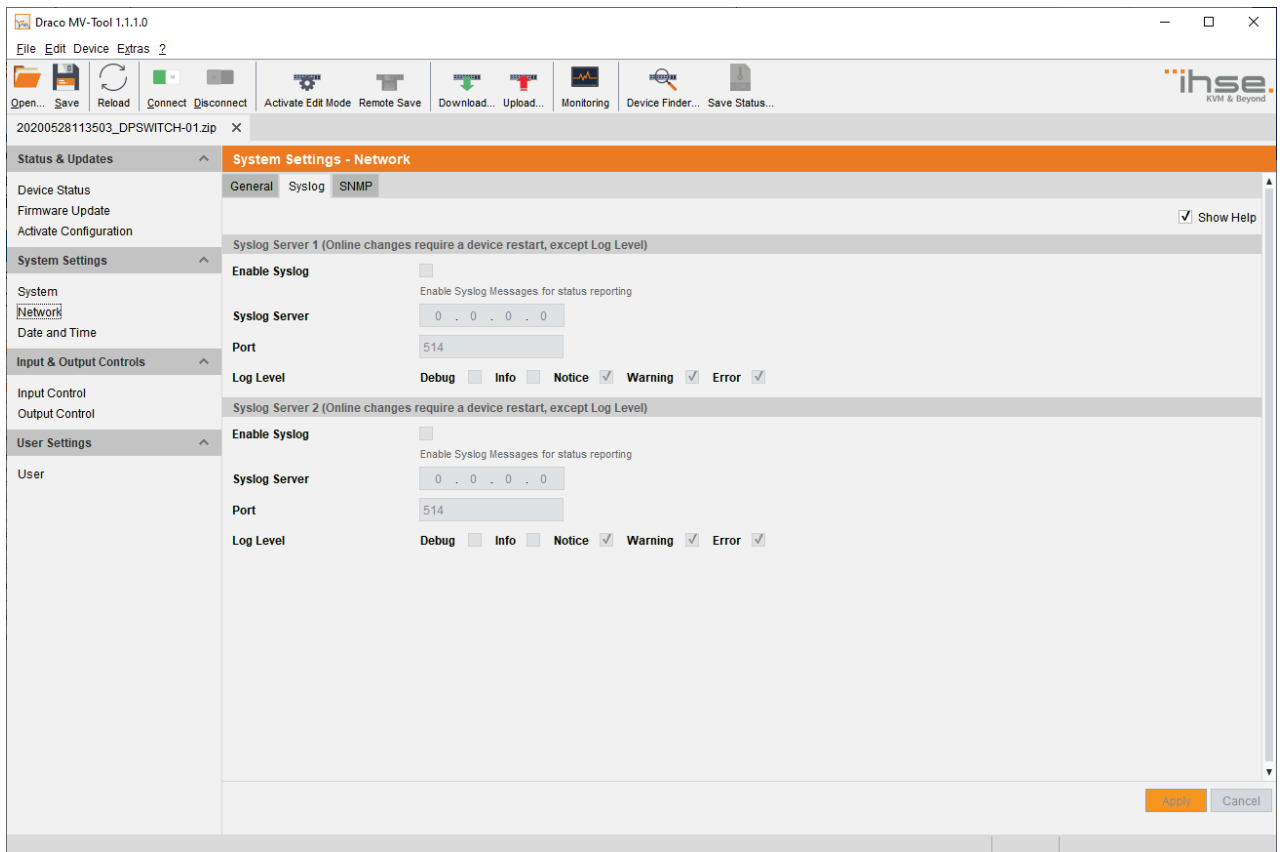

Fig. 46 Menu System Settings - Network - Syslog

The following parameters can be configured:

Field	Entry	Description
Enable Syslog	Check	Syslog server to query status is active
Syslog Server	Byte	Input of the IP address of the syslog servers in the form "192.168.1.1"
Port	Byte	Input of the syslog ports (default: 514)
Log Level	DEB	Activate debug messages in syslog (default: N) Note: The debug messages are exclusively for Draco MV diagnostics. Use this function only for concrete debug cases as it is not intended for normal operation.
	INF	Activate information messages in syslog (default: N)
	NOT	Activate notification messages in syslog (default: Y)
	WAR	Activate warning messages in syslog (default: Y)
	ERR	Activate error messages in syslog (default: Y)

To set parameters for the syslog function, proceed as follows:

1. Select **System Settings > Network** in the task area.
2. Select the **Syslog** tab in the working area.
3. Modify the desired settings.
4. Click the **Apply** button to confirm your entries.

Setting the syslog options

To set or activate the presetting, proceed as follows:

- ➔ Select **Extras > Options** in the menu bar and open the **Syslog** tab.

Fig. 47 Menu **Extras - Options - Syslog**

The following options are available:

Option	Description
Log File Directory	Default directory to store the log files
Log File Name	Default name of the log file
Log File Extension	Default extension for the log file
Daily Logfiles	Log files are stored every 24 hours (daily)
Maximum Log File Size [KB]	Allowed maximum size of log file
Maximum Number of Log Files	Allowed maximum number of log files

Option	Description
Acoustic Notification	Enables acoustic notification for errors
Autostart	When starting the management software, the syslog function will be started in the background
Open Monitoring Tab	When starting the management software, the monitoring tab will be opened



When reaching the maximum log file size, a new log file will be created. When reaching the maximum number of log files, the oldest logfile will be overwritten with the new information.

6.3.4 Setting SNMP Function

The SNMP function allows all function-critical and safety-critical elements of the Draco MV to be monitored and queried. This function complies with the RFC 1157 conformal standard. Two SNMP servers can be used at the same time.

NOTICE

When using SNMP monitoring, for reasons of access security, the use of a dedicated network according to the IT-Grundschutz catalog is recommended. The read only community for the MIB file is **draco**.

NOTICE

For an activation of the SNMP agent function or the SNMP server function, a restart of the Draco MV is necessary.

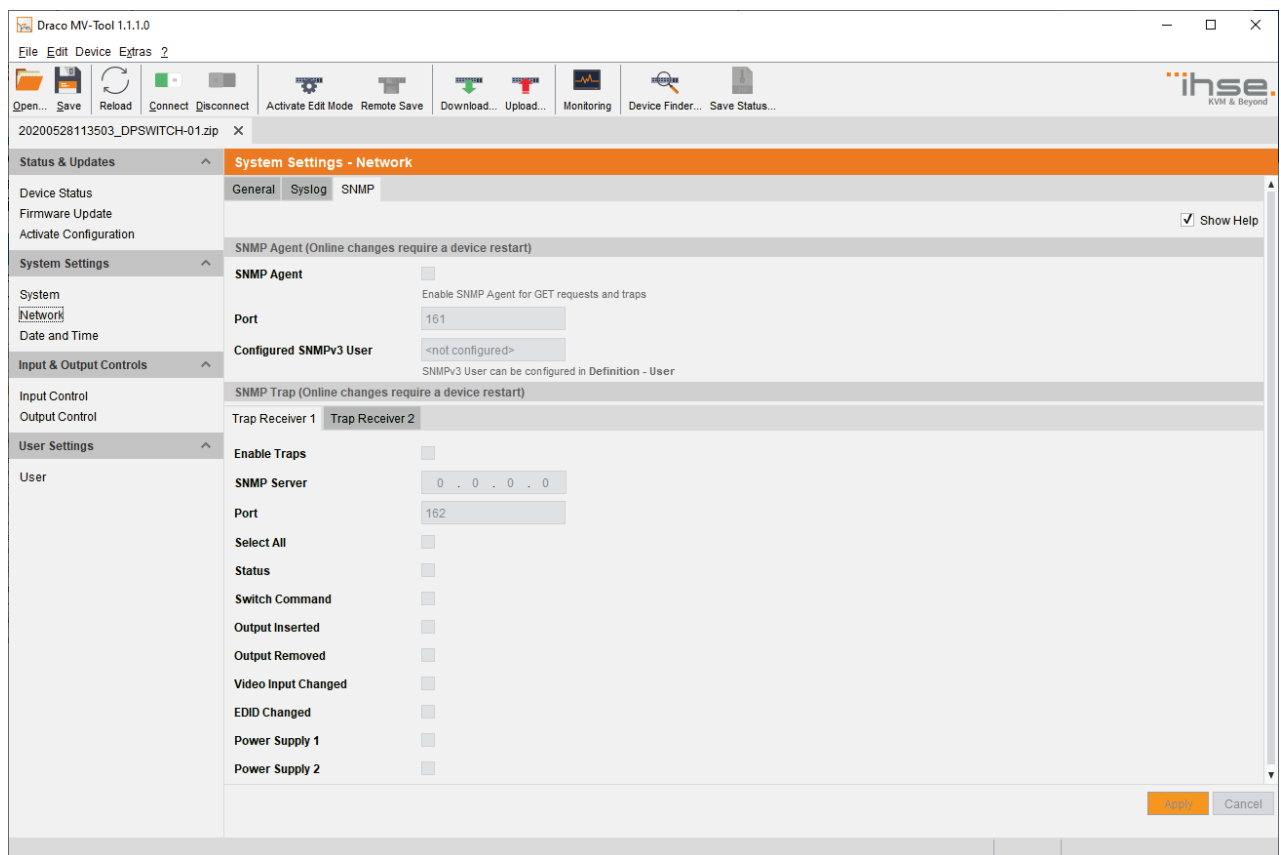

Fig. 48 Menu System Settings - Network - SNMP

The following parameters can be configured:

SNMP Agent

Traps	Description
SNMP Agent	Permission for an active query of the SNMP agent for traps is granted.
Port	The SNMP port is called up automatically, (default server 1: 161)
Configured SNMPv3 User	Name of the SNMP user (default: snmp)

SNMP Trap

Traps	Description
Enable Traps	Activation of the monitoring via traps
SNMP Server	Input of the IP address of the SNMP server in the form "192.168.1.1"
Port	Input of the SNMP port (default server 2: 162)
Select All	Select all traps
Switch Command	Notification about a performed switching operation at the Draco MV
Output Inserted	<ul style="list-style-type: none"> Notification about a newly connected console to the Draco MV Benachrichtigung über eine angeschaltete Konsole
Output Removed	<ul style="list-style-type: none"> Notification about a removed console from the Draco MV Notification about a switched-off console
Video Input Changed	Notification about a change of resolution or change of frequency
EDID Change	Notification about a change in EDID information at the inputs
Power Supply 1	Notification about the status of power supply unit #1
Power Supply 2	Notification about the status of power supply unit #2

Activating the SNMP agent

To activate the SNMP agent, proceed as follows:

1. Select **System Settings> Network** in the task area.
2. Select the **SNMP** tab in the working area.
3. Click the **SNMP Agent** checkbox within the **SNMP Agent** area.

By activating this option, the permission for an active query of the SNMP agent is granted.

4. Click the **Apply** button to confirm your changes.

Configuring SNMP traps

To activate the SNMP traps, proceed as follows:

1. Click the **Enable Traps** checkbox within the **SNMP Trap** area.

This function allows an active transmission of trap messages from the SNMP agent to the SNMP server.

2. Enter the IP address of the SNMP server under **SNMP Server**.
3. Activate the checkboxes of the desired traps to activate them.
4. Click the **Apply** button to confirm your changes.

Setting up SNMP options

Default settings and the settings for an SNMPv3 user are set in this menu.

To set or activate the presetting, proceed as follows:

➔ Select **Extras > Options** in the menu bar and open the **SNMP** tab.

Fig. 49 Menu **Extras - Options - SNMP**

The following options are available:

Option	Description
Port	SNMP Port
Log File Directory	Default directory to store the log files
Log File Name	Default name of the log file
Log File Extension	Default extension for the log file
Daily Logfiles	Log files are stored every 24 hours (daily)
Maximum Log File Size [KB]	Allowed maximum size of log file
Maximum Number of Logfiles	Allowed maximum number of log files
Acoustic Notification	Enables acoustic notification for errors
Autostart	When starting the management software, the SNMP function will be started in the background
Open Monitoring Tab	When starting the management software, the monitoring tab will be opened

To configure the settings for the SNMPv3 User, proceed as follows:

1. Click the **Manage SNMPv3 Users** button.
A list appears with already created SNMPv3 users.
2. Click the **Add User** button.
A dialog window appears.
3. Enter the required data and click the **Ok** button to confirm your entries.
4. Click the **Close** button to close the users list.
5. Click the **Ok** button in the **SNMP** tab to confirm your settings.

The image shows a screenshot of the 'Manage SNMPv3 Users' dialog box. The main dialog has a title bar 'Manage SNMPv3 Users' and a close button (X). It contains a table with columns: Username, Auth Protocol, Auth Password, Priv Protocol, and Priv Password. Below the table are two buttons: 'Add User' and 'Remove selected Users'. At the bottom is a 'Close' button. An 'Add User' sub-dialog is open in the center, containing the following fields:

- Username:
- Authentication Protocol: SHA (dropdown menu)
- Authentication Password:
- Privacy Protocol: DES (dropdown menu)
- Privacy Password:

At the bottom of the sub-dialog are 'Ok' and 'Cancel' buttons.

Fig. 50 Menu Extras - Options - SNMP - Manage SNMPv3 Users - Add User

6.3.5 Setting Date and Time

The parameters for the system configuration are set in this menu, based on Simple Network Time Protocol (SNTP):

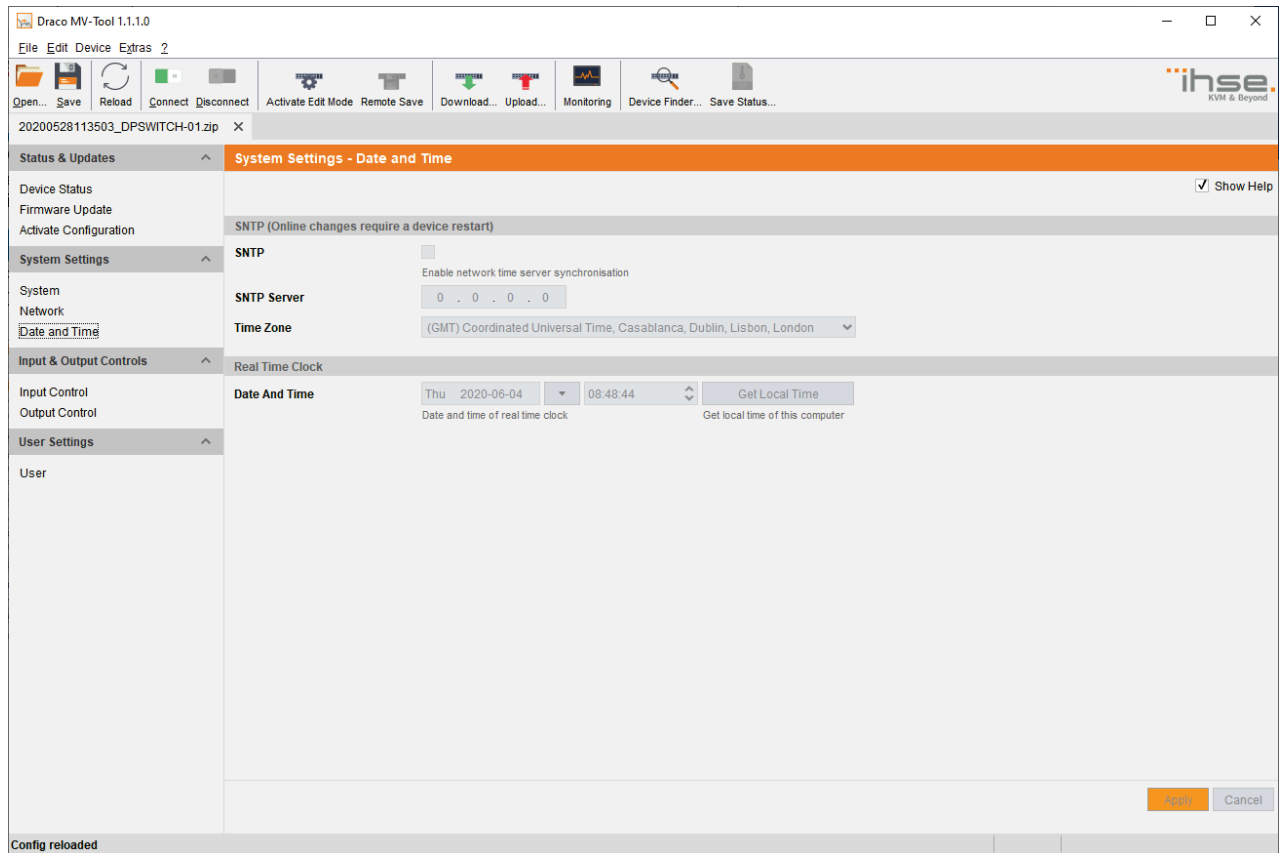

Fig. 51 Menu **System Settings - Date and Time**

The following parameters can be configured:

SNTP

Field	Entry	Description
SNTP	Checkmark	Enable network time server synchronization
SNTP Server	Byte	Input of the SNTP server IP address (default: 000.000.000.000)
Time Zone	Region	Set your specific time zone

Real Time Clock

Field	Description
Date*	Date and time of real time clock
Get Local Time	Get local time of this computer

Configuring the time server

To configure a time server, proceed as follows:

1. Select **System Settings > Date and Time** in the task bar.
2. Activate the **SNTP** checkbox to enable the SNTP option.
3. Enter the IP address of your SNTP server in the **SNTP Server** field.
4. Select your time zone in the **Time Zone** field.
5. Click the **Apply** button to confirm your settings.
6. Restart the Draco MV. The system time will be now provided by the SNTP server.

Configuring the real time clock without time server

To set the real time clock without using SNTP, proceed as follows:

1. Select **System Settings > Date and Time** in the task bar.
2. Set the current date in the **Date and Time** field.
3. Set the current time in the **Date and Time** field.
4. Click the **Apply** button to set the system time
5. Option: If you want to receive the time from your currently used computer, click the **Get Local Time** button.

6.4 Configuration of Video Ports

6.4.1 Setting Video Inputs Parameters

The parameters for the video inputs are set in this menu:

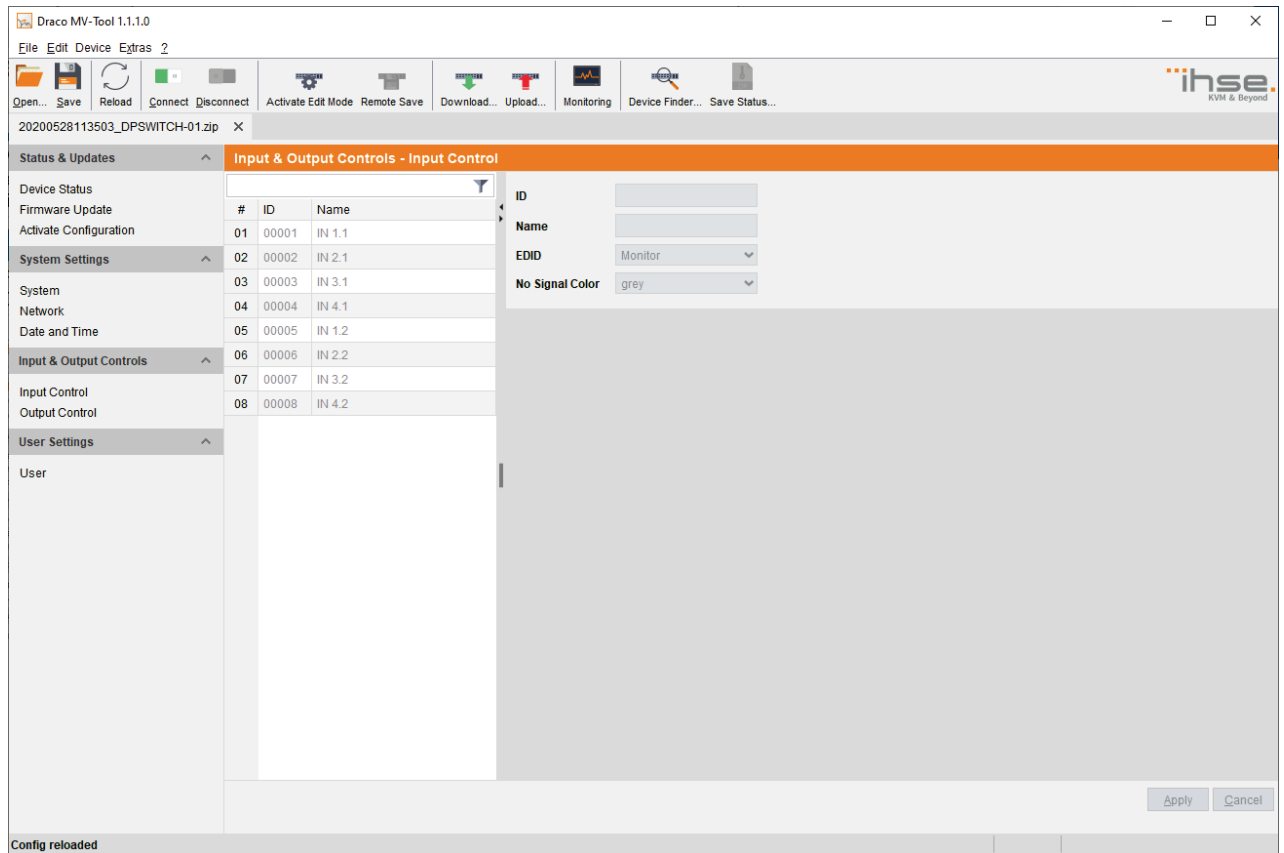

Fig. 52 Menu *Input & Output Controls - Input Control*

The following parameters can be configured:

Field	Entry	Description
Name	Text	Optional: Individual name for video inputs (case sensitive) Note: An individual name can consist of up to 32 characters.
Default EDID	List	MONITOR When the Draco MV is restarted or a monitor is plugged in during operation, the monitor's EDID is read out and transmitted to the CPU inputs. The video signal is always displayed with the resolution of the monitor.
		1080p60 When the Draco MV is restarted or a monitor is plugged in during operation, the video signal is always displayed with the preset resolution.
		4K30 4K60
No Signal Color	List	Background color if no video signal is available



Using the Fullscreen display mode:

If there is no video signal input, a notification is displayed: NO SYNC OR SIGNAL.

To configure the settings for a video input, proceed as follows:

1. Select **Input & Output Controls > Input Control** in the task area.
2. Select the video input to be configured in the list **Input Devices**.
3. Modify the desired settings.
4. Click the **Apply** button to confirm your settings.

6.4.2 Setting Video Outputs Parameters

The parameters for the video outputs are set in this menu:

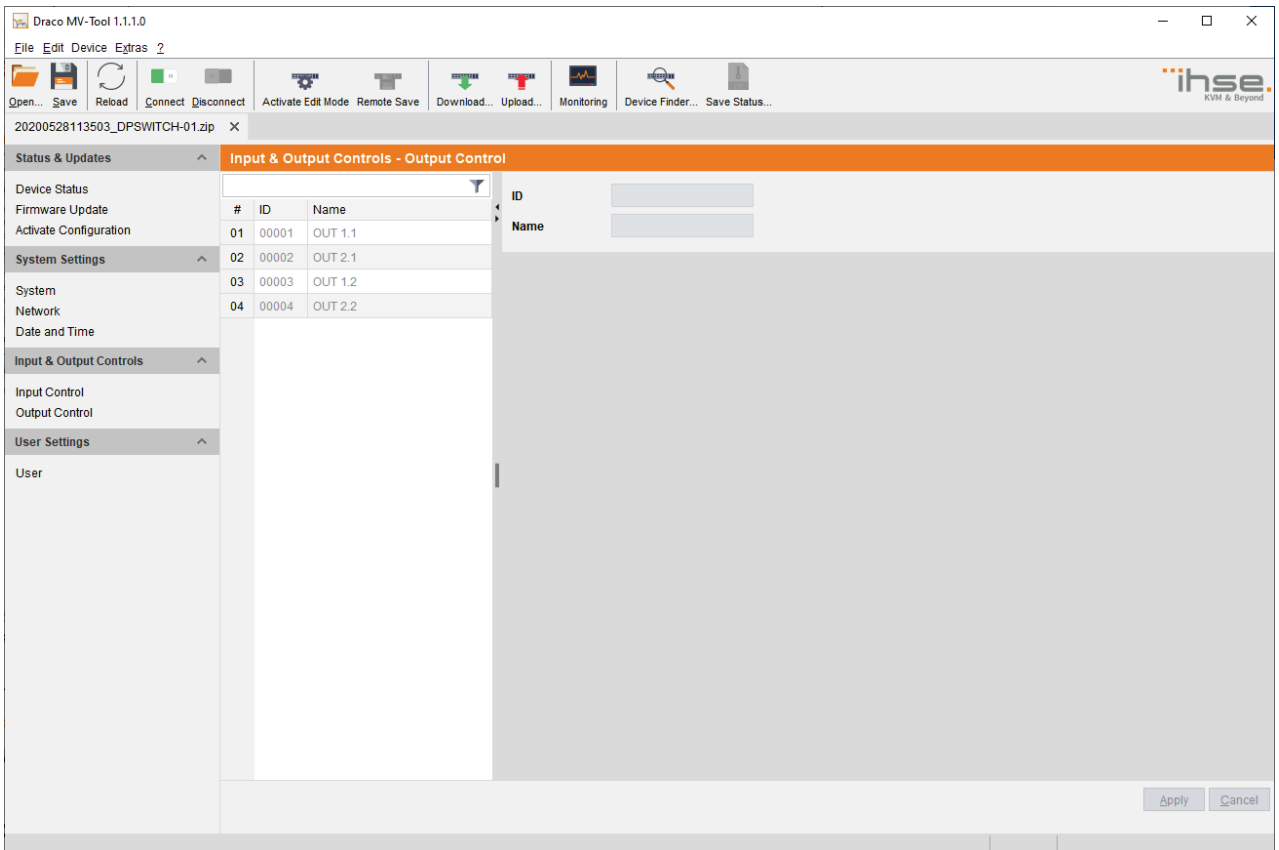

Fig. 53 Menu **Input & Output Controls - Output Control**

The following parameters can be configured:

Field	Entry	Description
Name	Text	Optional: Individual name for video inputs (case sensitive) Note: An individual name can consist of up to 32 characters.

To configure the settings for a video output, proceed as follows:

1. Select **Input & Output Controls > Output Control** in the task area.
2. Select the video input to be configured in the list **Output Devices**.
3. Modify the desired settings.
4. Click the **Apply** button to confirm your settings.

6.5 User Settings

New users and their user settings and permissions are set in this menu:

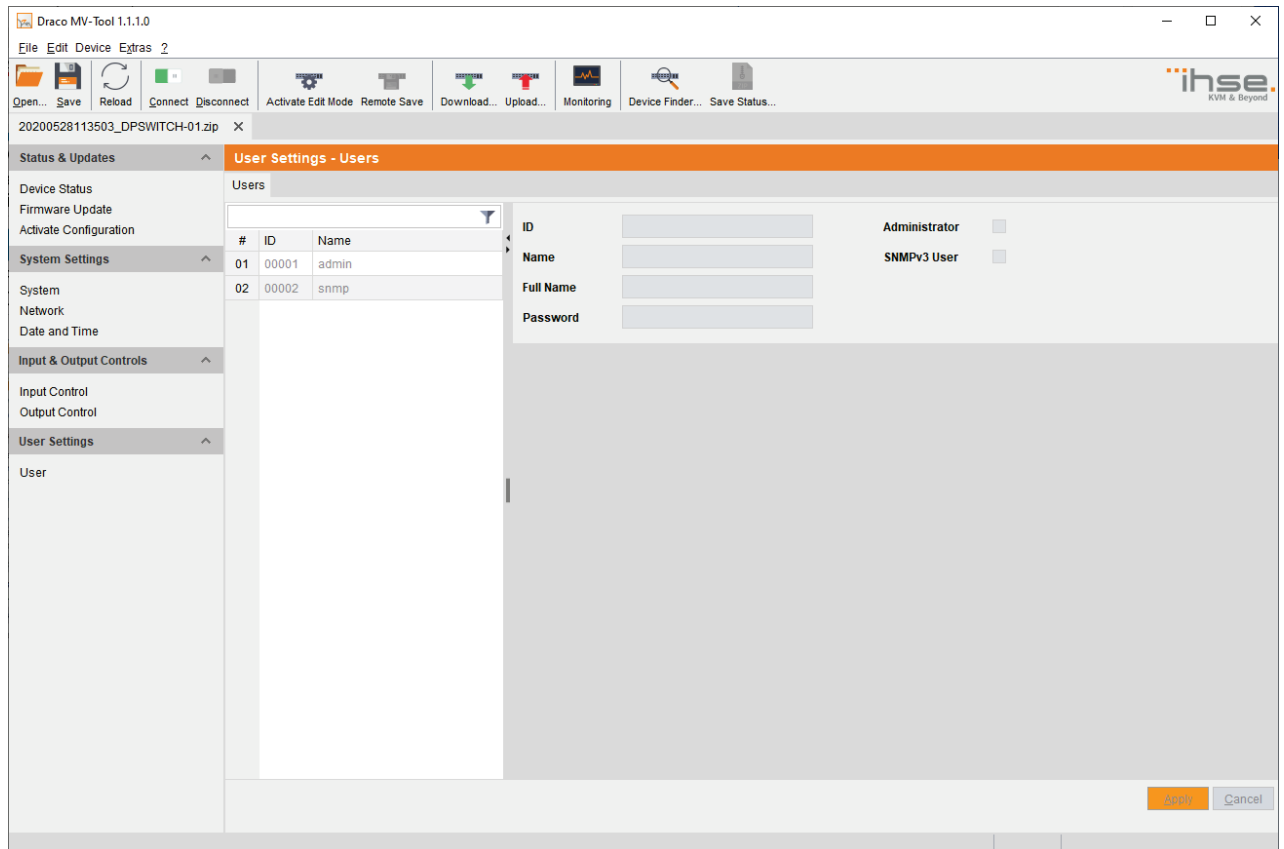

Fig. 54 Menu User Settings - Users

Administrator

The administrator has the permission to configure the system. The following parameters can be configured for the administrator:

Field	Entry	Description
Full Name	Text	Optional: personal username (case sensitive) Note: A personal username can consist of up to 32 characters.
Password	Text	User password (case sensitive)

SNMPv3 User

The SNMPv3 user has the permission to enable encrypted SNMPv3. The following parameters can be configured for the SNMPv3 user:

Field	Entry	Description
Full Name	Text	Optional: personal username (case sensitive) Note: A personal username can consist of up to 32 characters.
Password	Text	User password (case sensitive)
SNMPv3 User	Y/N	Y = Permission to use SNMPv3 (encrypted) (default: N)

Editing user settings

To edit settings of an existent user, proceed as follows:

1. Select **Configuration > User Data** in the main menu.
2. Select a user in the **User List**.
3. Click the **Edit** button to open the edit mode.
4. Modify the desired settings.
5. Click the **Okay** button to confirm your entries.

6.6 Saving Configuration

NOTICE

By default, the last configuration that has been saved in the permanent Draco MV memory will be restored after a restart of the Draco MV.

First starting the Draco MV, the factory configuration will be copied in the current configuration. You have 3 possibilities to save configuration changes:

- saving the current configuration permanently in the Draco MV memory
- saving the configuration in up to 8 predefined storage locations, as well as the default configuration in the memory of the Draco MV
- saving configuration on a local memory

6.6.1 Saving Active Configuration to the Draco MV

NOTICE

Changing or saving configurations blocks the Draco MV memory and leads to a freeze of all OSD menus for a few seconds. The switching connections are not affected by this freeze.



By default, the last configuration that has been saved in this way will be restored after a restart of the Draco MV.

To save the current configuration permanently in the Draco MV memory, proceed as follows:

1. Select the **Remote Save** menu item in the toolbar.

A query to save the configuration appears.

2. Click the **Yes** button to confirm the saving.

The previously active configuration is overwritten and saved in the permanent memory of the Draco MV.

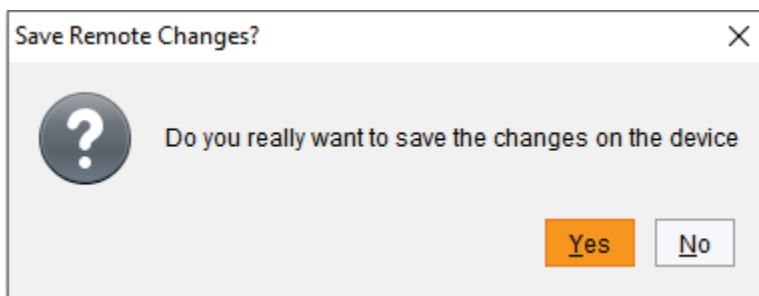

Fig. 55 Menu **Remote Save**

6.6.2 Uploading Predefined Configurations to the Draco MV

Using the function **Upload**, the created configuration can be saved within eight storage locations in the Draco MV (**File#1** to **File#8**). However, it does not replace the buffering of configuration (see chapter 5.6.1, page 54).

Additionally, a configuration can also be saved as default configuration that can be automatically loaded with each start (see chapter 6.3.1, page 63).

To upload an opened configuration to the Draco MV, proceed as follows:

1. Select the **Upload** menu item in the toolbar.
An access window appears.
2. Enter the IP address of the Draco MV in the entry field.
3. Enter the username and password of the administrator.
4. Click the **Next** button to display the selection of storage slots.

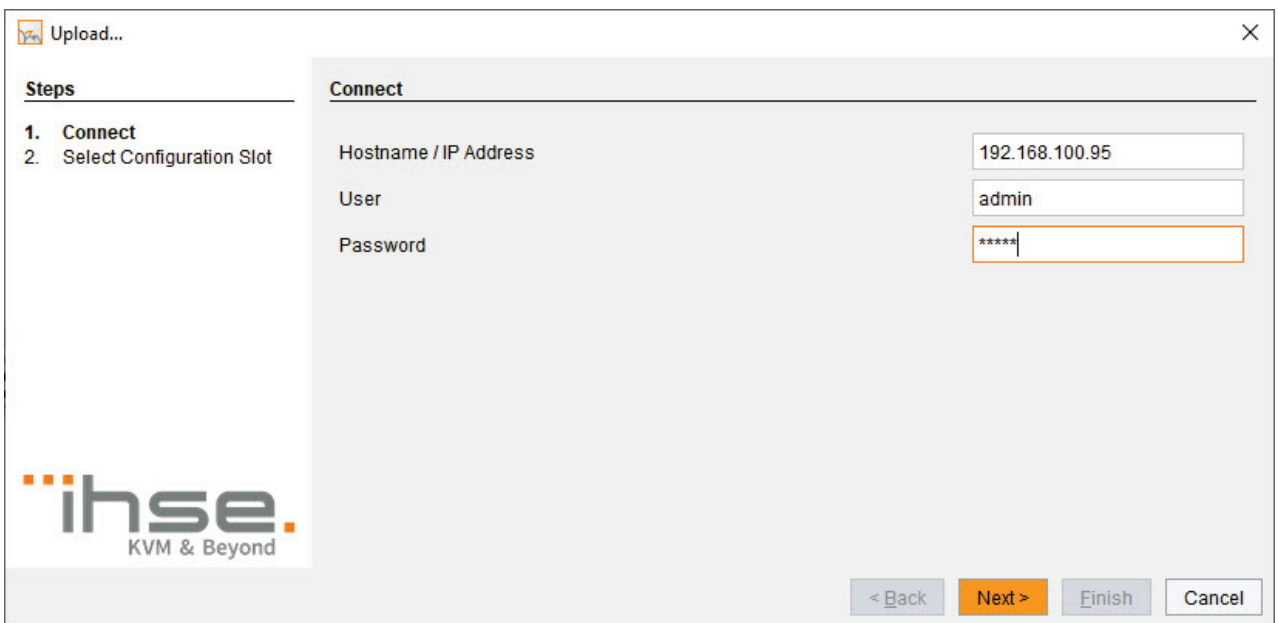

Fig. 56 Menu **Upload - Connect**

5. Under **Select Configuration Slot**, select the storage slot for the configuration (**default** or **config01** to **config08**).
6. Option: To activate the uploaded configuration immediately, click the **Activate configuration after upload** check box.

NOTICE

If you click the **Activate configuration after upload** option, the Draco MV will be restarted immediately after the save process has been completed. The restart of the Draco MV may take several minutes, and the Draco MV is not available during the restart.

7. Click the **Finish** button to save the configuration to the selected storage location.

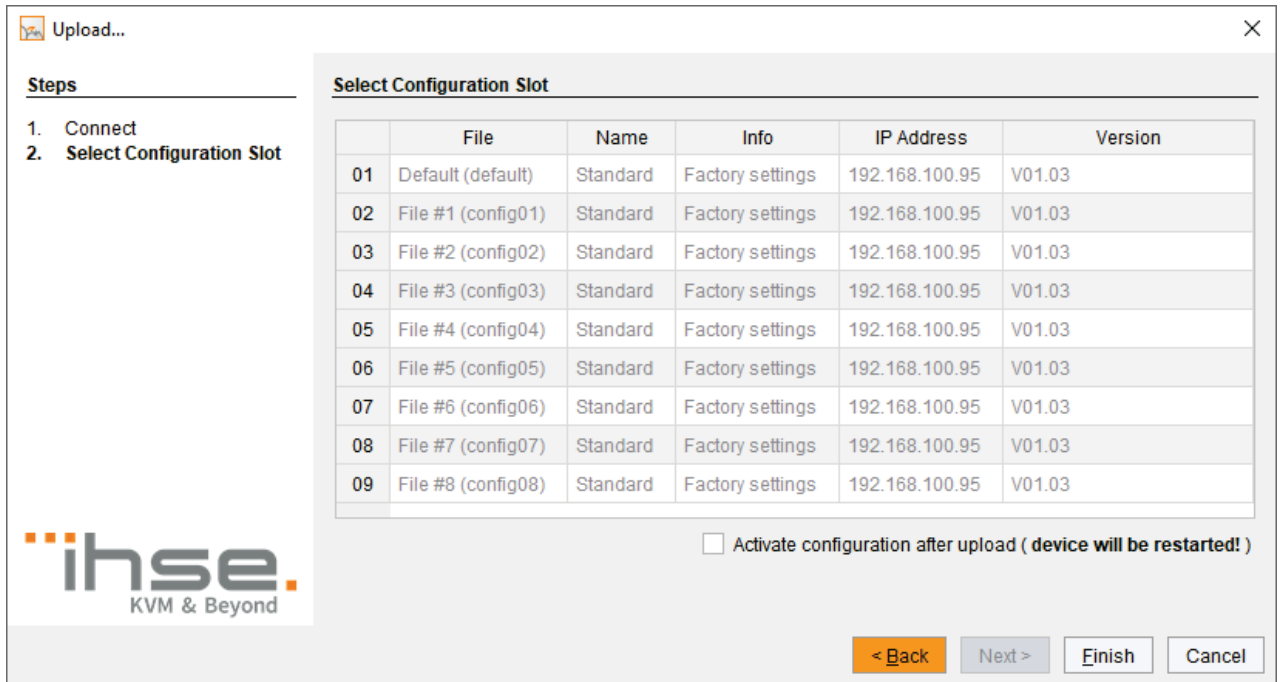

Upload...

Steps

1. Connect
2. **Select Configuration Slot**

Select Configuration Slot

	File	Name	Info	IP Address	Version
01	Default (default)	Standard	Factory settings	192.168.100.95	V01.03
02	File #1 (config01)	Standard	Factory settings	192.168.100.95	V01.03
03	File #2 (config02)	Standard	Factory settings	192.168.100.95	V01.03
04	File #3 (config03)	Standard	Factory settings	192.168.100.95	V01.03
05	File #4 (config04)	Standard	Factory settings	192.168.100.95	V01.03
06	File #5 (config05)	Standard	Factory settings	192.168.100.95	V01.03
07	File #6 (config06)	Standard	Factory settings	192.168.100.95	V01.03
08	File #7 (config07)	Standard	Factory settings	192.168.100.95	V01.03
09	File #8 (config08)	Standard	Factory settings	192.168.100.95	V01.03

Activate configuration after upload (device will be restarted!)

ihse.
KVM & Beyond

< Back Next > Finish Cancel

Fig. 57 Menu **Upload** - **Select Configuration Slot**

6.6.3 Saving of Predefined Configurations Locally

Configurations can be saved as a file that can be stored independent of the Draco MV.

To save a configuration file locally, proceed as follows:

1. Select **File > Save As** in the menu bar.
2. Enter a name for the configuration.
3. Select the directory of the configuration on your storage medium where the configuration is to be saved.



Configurations are always saved in a file with the ending .dmc.

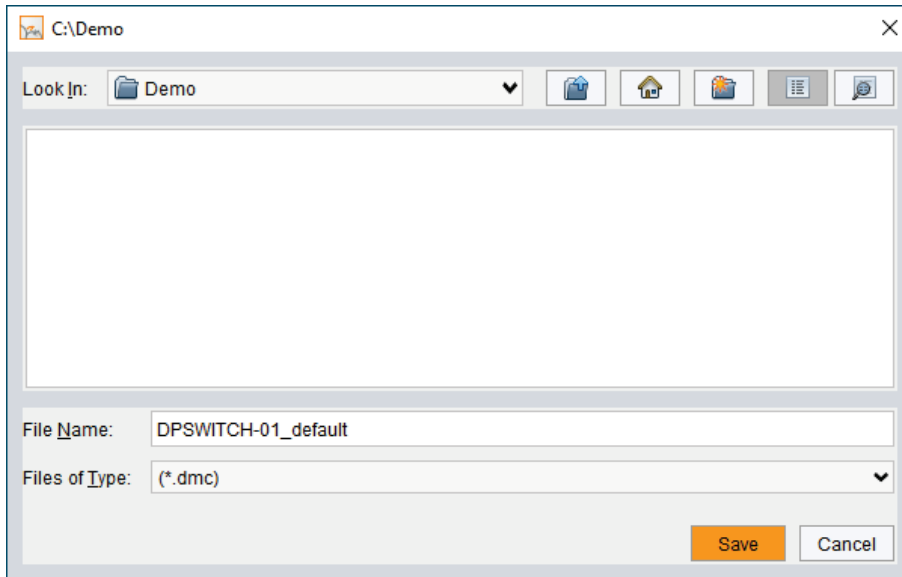

Fig. 58 Menu File - Save As...

Local saved configurations files can be opened in the management software (see chapter 6.9, page 86), be uploaded to the Draco MV (see chapter 6.6.2, page 81) and be used as active configuration (see chapter 6.7, page 84) in the system.

6.7 Activating Predefined Configuration

To activate an uploaded configuration, proceed as follows:

1. Select **Status & Updates > Activate Configuration** in the task area.
2. Select the configuration to be activated.
3. Click the **Activate** button to activate the selected configuration.

A query to restart the Draco MV appears.

4. Click the **Yes** button to confirm the restart.

The connection is disconnected, and the Draco MV is restarted. The selected configuration is loaded on restart and is shown in the menu as active configuration under **Active Configuration** in the work area. The previously active configuration is overwritten

NOTICE

The restart of the Draco MV may take several minutes, and the Draco MV is not available during the restart.

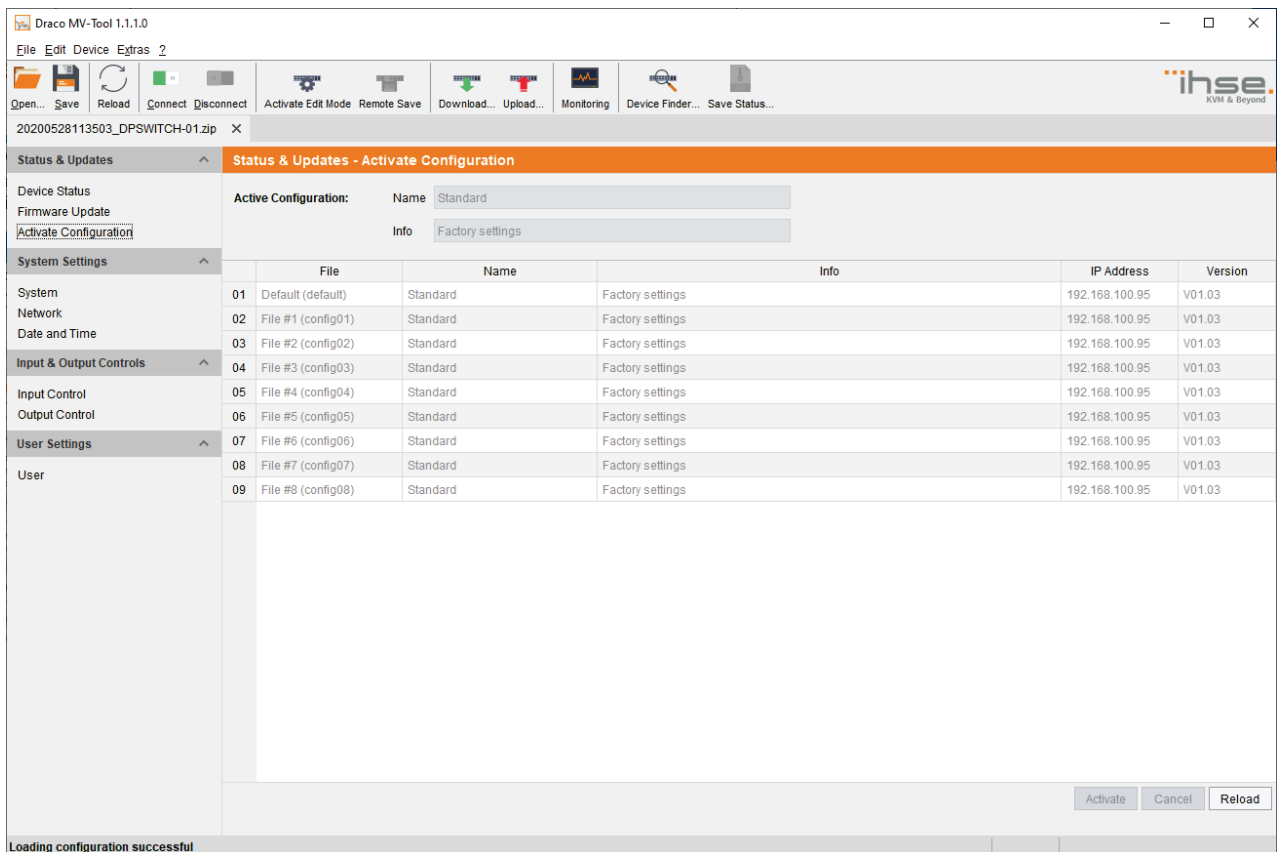

Fig. 59 Menu **Status & Updates - Activate Configuration**

6.8 Downloading Predefined Configuration from the Draco MV

Configurations saved in the Draco MV can be downloaded for offline editing in this menu.

To download a configuration from the Draco MV, proceed as follows:

1. Select the **Download** menu item in the toolbar.
An access window appears.
2. Enter the IP address of the Draco MV in the entry field.
3. Enter the username and password of the administrator.
4. Click the **Next** button to display the selection of storage location.



Fig. 60 Menu **Download - Connect**

5. Under **Select Configuration**, select the storage location of the desired configuration (**default** or **config01** to **config08**).
6. Click the **Finish** button to download the desired configuration to management software.

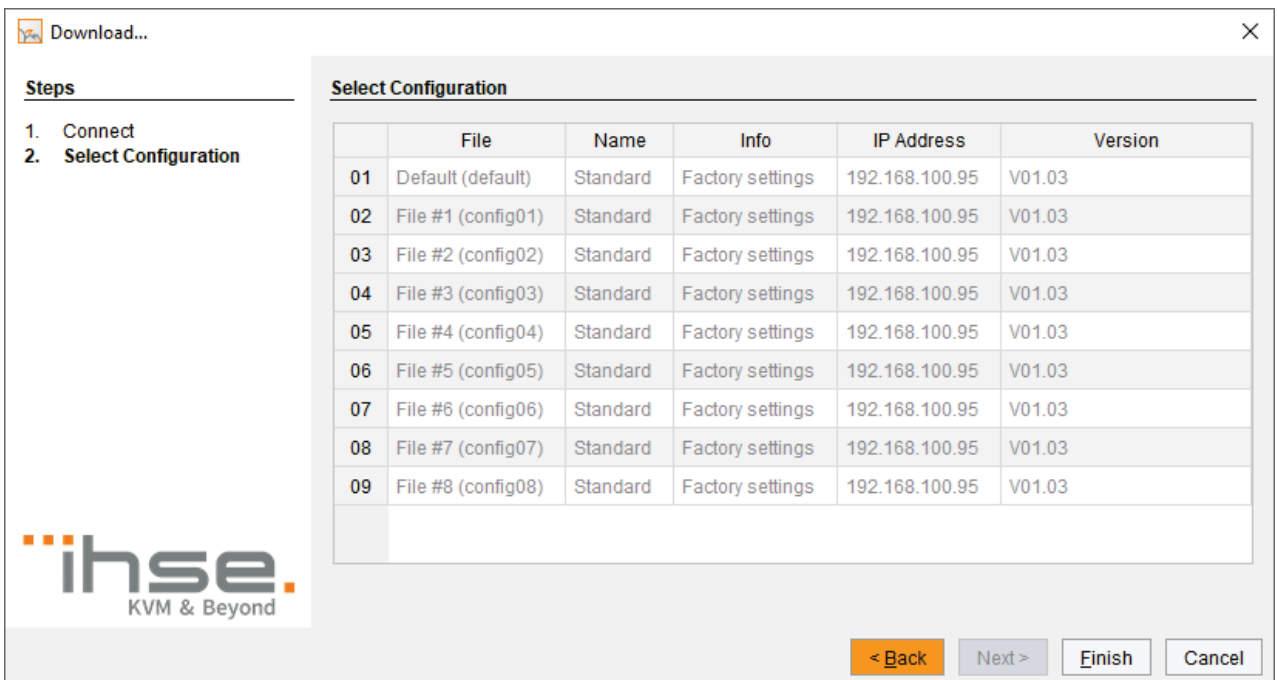

Fig. 61 Menu **Download - Select Configuration**

6.9 Opening Locally Saved Configuration

To load a locally saved configuration, proceed as follows:

1. Select **File > Open...** menu item in the toolbar
2. Navigate to the location of the configuration file to be opened.
3. Click the configuration file to be opened.
4. Click the **Open** button, to open the configuration file.

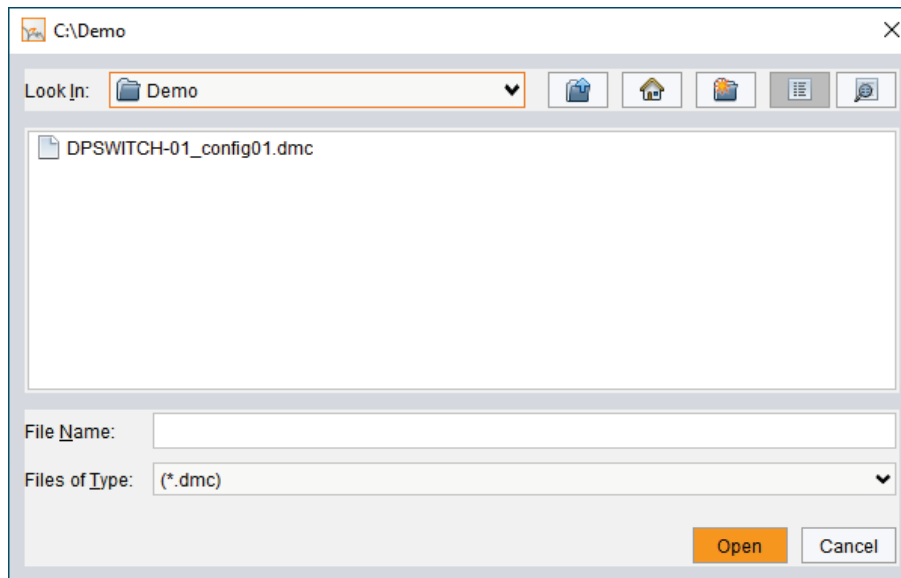

Fig. 62 Menu File - Open



The configuration can also be opened via drag & drop. To do this, click on the configuration file, hold the mouse button down and drag the configuration file into the management software.

7 Operation

7.1 Switching a Source

7.1.1 Switching via Keyboard

From your console, you can switch between different sources using a keyboard sequence as follows.

1. Open command mode with the 'Hot Key' (see chapter 3.8.1, page 26).
2. Enter the number of the specific source or monitor and press the `<Enter>` key.
Command Mode will close, and the keyboard LEDs will return to their previous status.
Keyboard and mouse are connected to the specified source.



When using the numeric keypad for switching, a confirmation of the switching operation by using the `<Enter>` key is not necessary

7.1.2 Switching via External Keypad

Optionally, you can connect an external keypad with a GPIO interface to switch to the respective source.

The GPIO interface is separately available for each USB-HID port with CPU connection

7.1.3 Switching via OSD

To switch to another source, proceed as follows:

1. Select in the main menu **Switch**.
2. Select the desired source under **Input Sources** and press the `<Enter>` key.

The switched source is immediately displayed on the console.

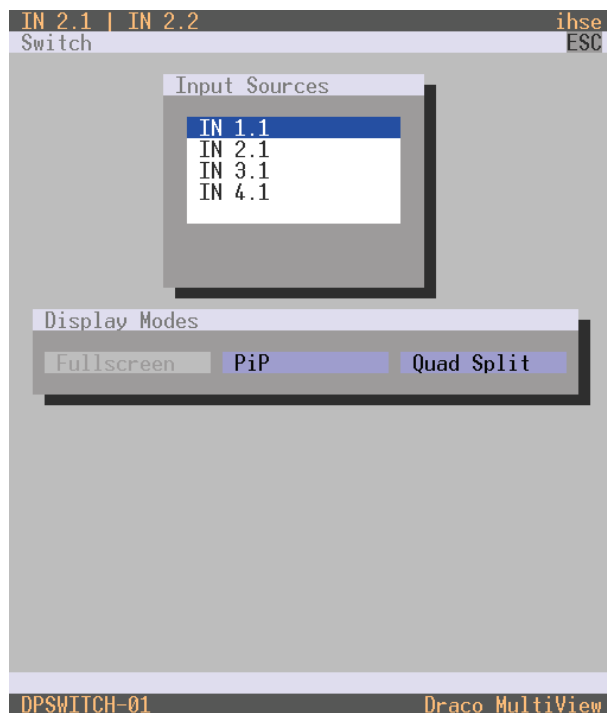

Fig. 63 Menu **Switch (Input Sources)**

7.2 Changing Display Mode

7.2.1 Changing Display Mode via Keyboard

From your console, you can change the display mode using a keyboard sequence as follows.

1. Open command mode with the 'Hot Key' (see chapter 3.8.1, page 26).
2. Press the corresponding function key according to the following overview.

The selected display mode is immediately displayed on the console.

Function key	Display mode
<F1>	Fullscreen
<F2>	Quad Split
<F3>	PiP

7.2.2 Changing Display Mode via OSD

To change the display mode on the console, proceed as follows:

1. Select in the main menu **Switch**.
2. Select the desired display mode under **Display Mode** and press the `<Enter>` key.

The selected display mode is immediately displayed on the console.

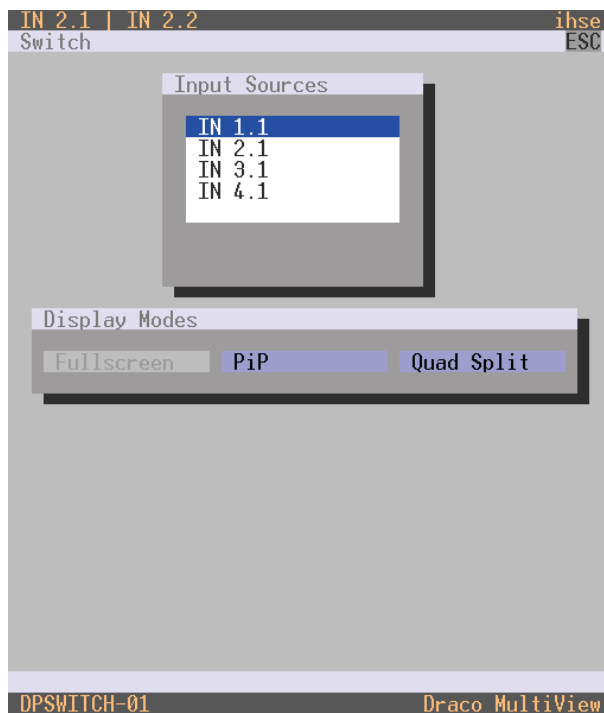

Fig. 64 Menu **Switch (Display Modes)**

7.3 Querying Status for Diagnosis via OSD

Various statuses can be queried for diagnosis:

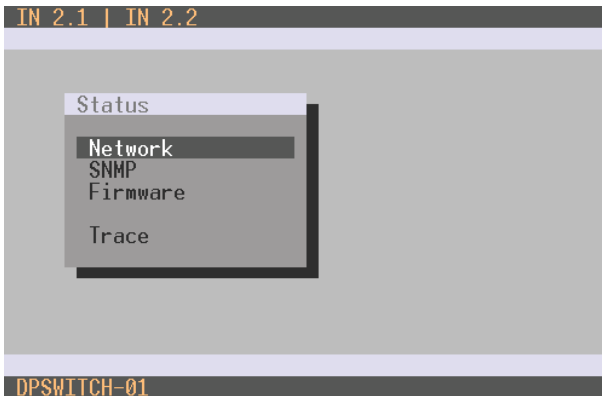

Fig. 65 Menu Status

7.3.1 Network Status

The current network configuration is displayed in this menu.

➔ Select in main menu **Status > Network**, to query the network configuration.

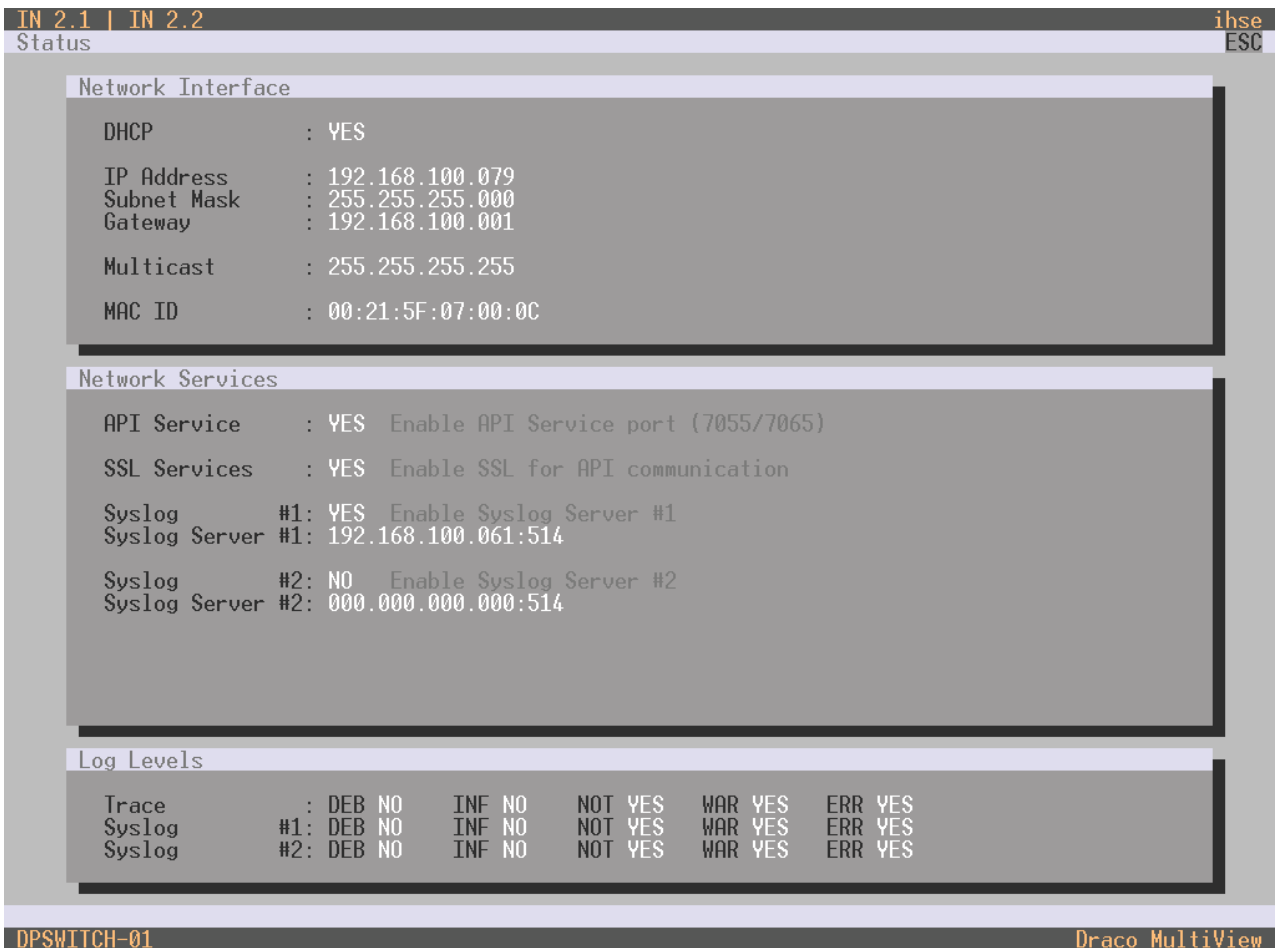

Fig. 66 Menu Status - Network



For information about the parameters, please refer to chapter 5.3.3, page 44.

7.3.2 Firmware Status

The current firmware status is displayed in this menu.

➔ Select in main menu **Status > Firmware**, to query the firmware status.

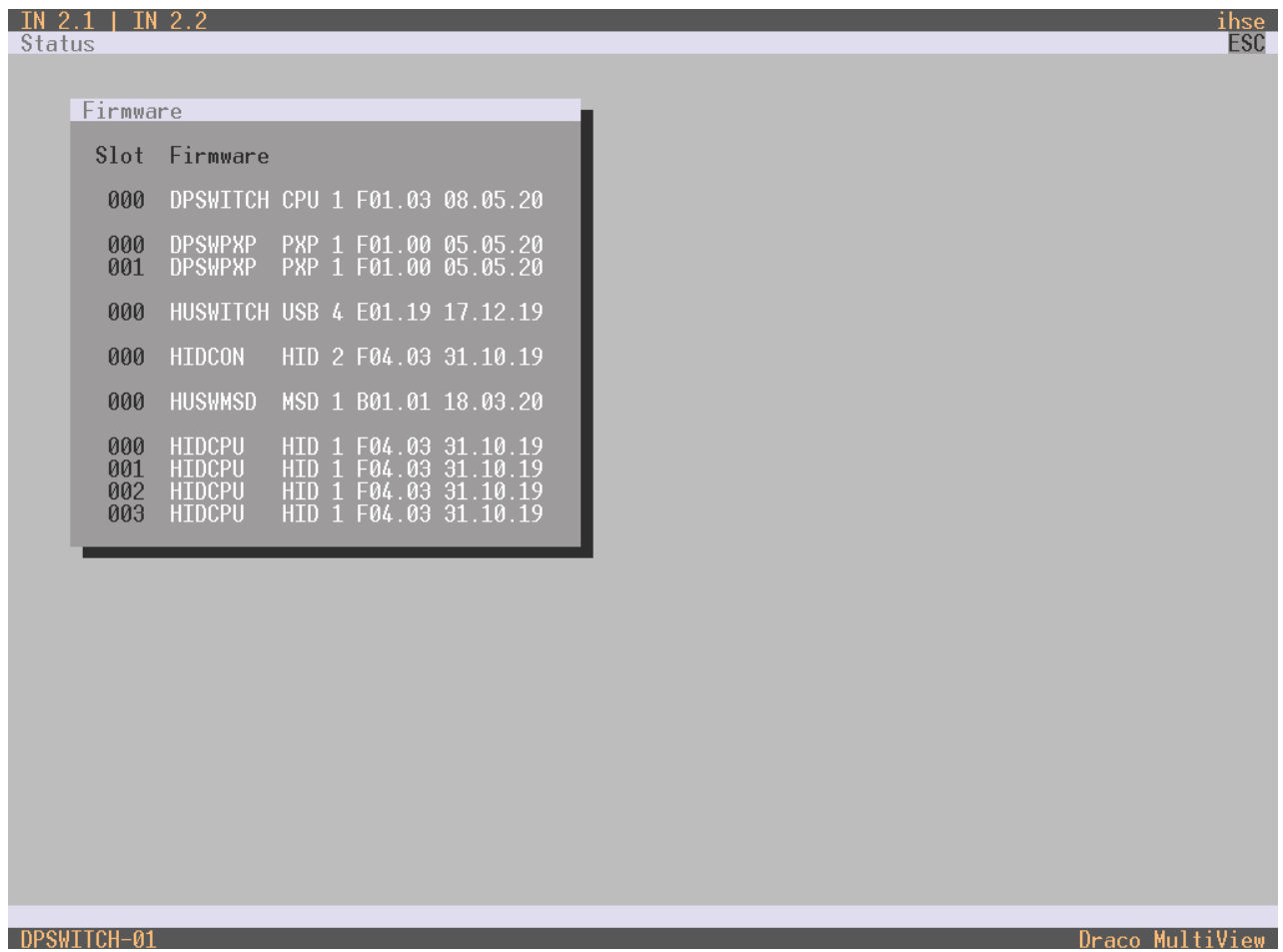

Fig. 67 Menu **Status - Firmware**

7.3.3 Trace

The trace function is used for diagnostic purposes. All recorded events for activities and switching operations are displayed in this menu.

➔ Select in main menu **Status > Trace**, to display the recorded events of the Draco MV.

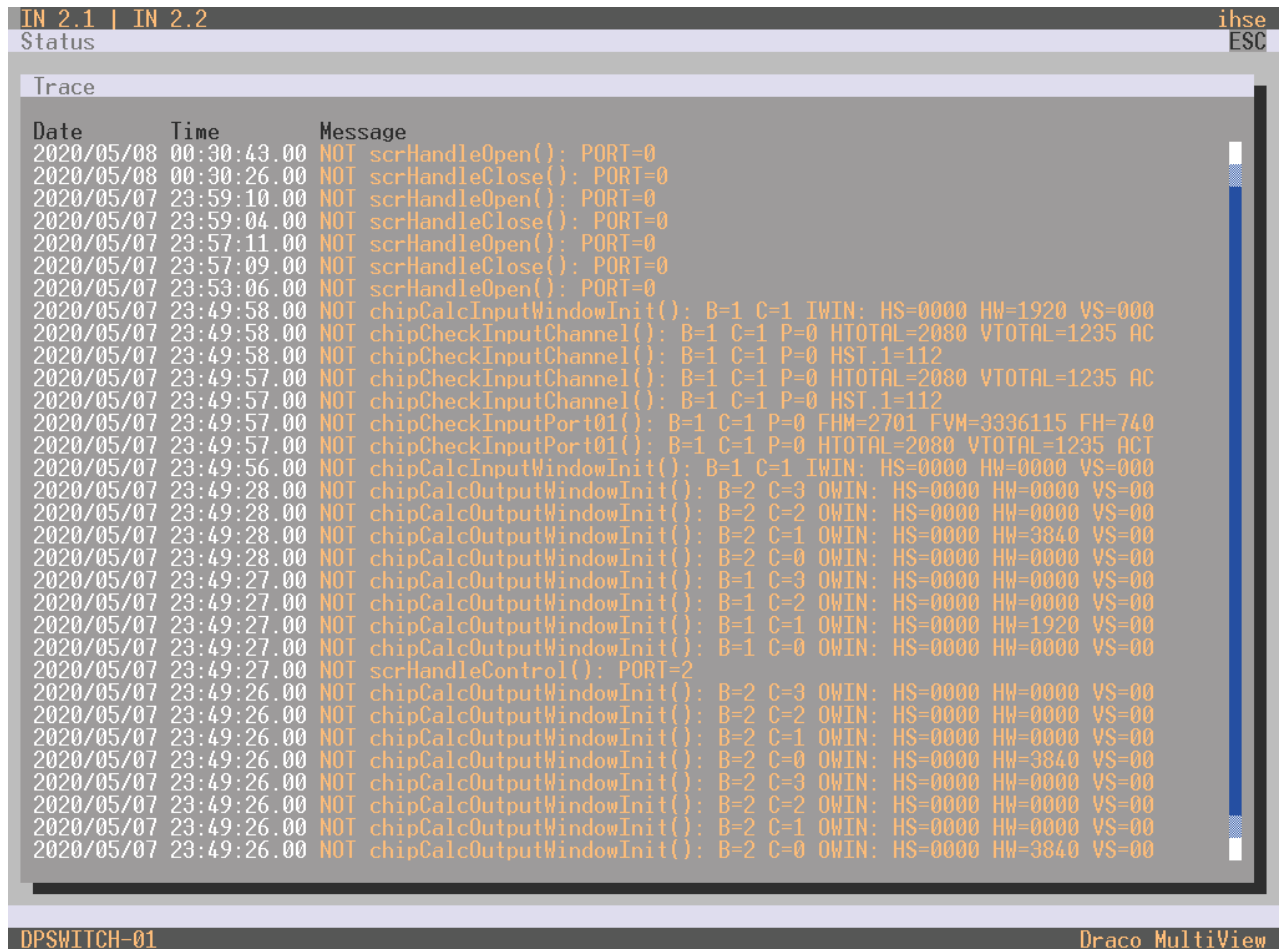

Fig. 68 Menu Status - Trace

7.4 Querying Status for Diagnosis via Management Software

7.4.1 Device Status

The connections to the Draco MV are displayed in this menu.

➔ Select **Status & Updates > Device Status** in the task area, to display the current connections.

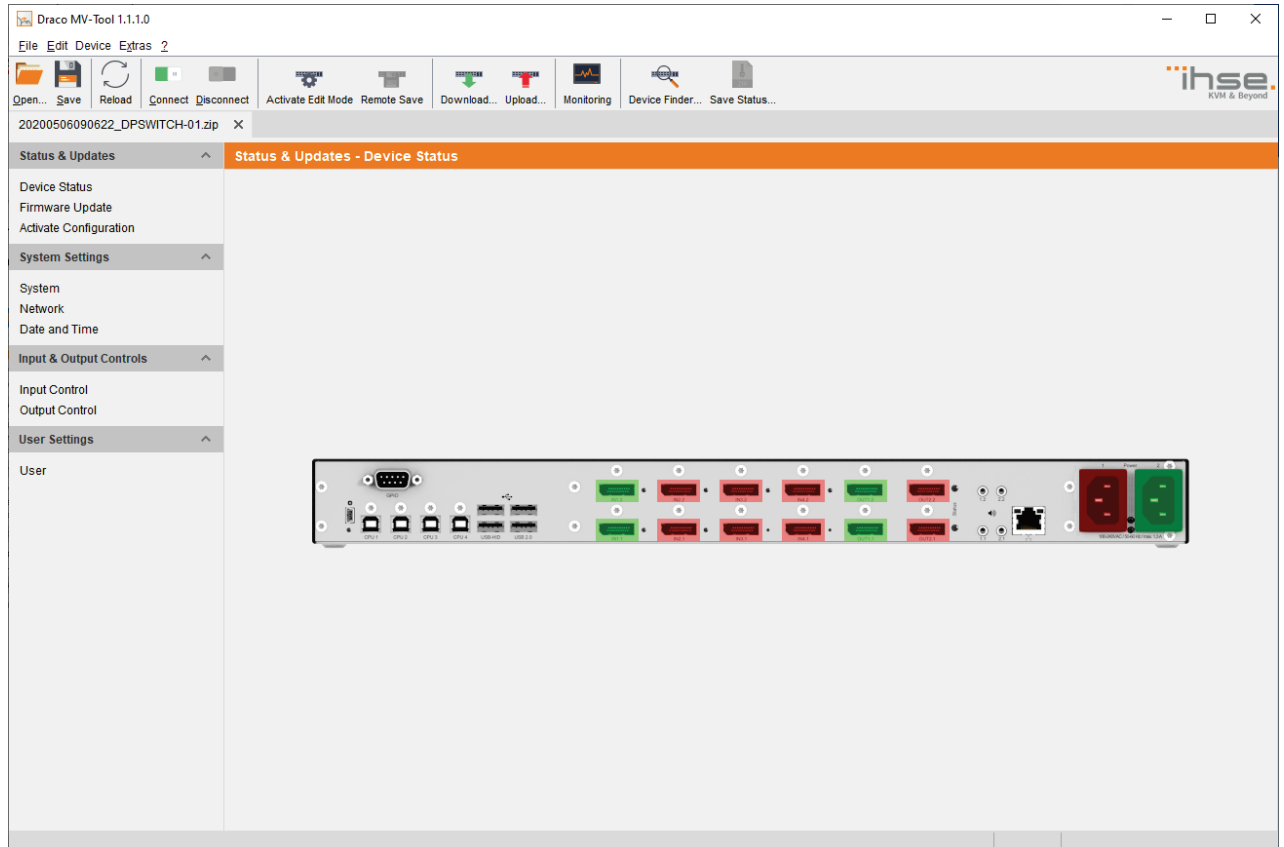

Fig. 69 Menu **Status & Updates - Device Status**

Port color	Description
Green	Port is connected
Red	Port is not connected



The connection on the network port is indicated at the port via LEDs.

7.4.2 Network Status

The current network configuration is displayed in this menu.

➔ Select **System Settings > Network** in the task area, to query the network configuration.

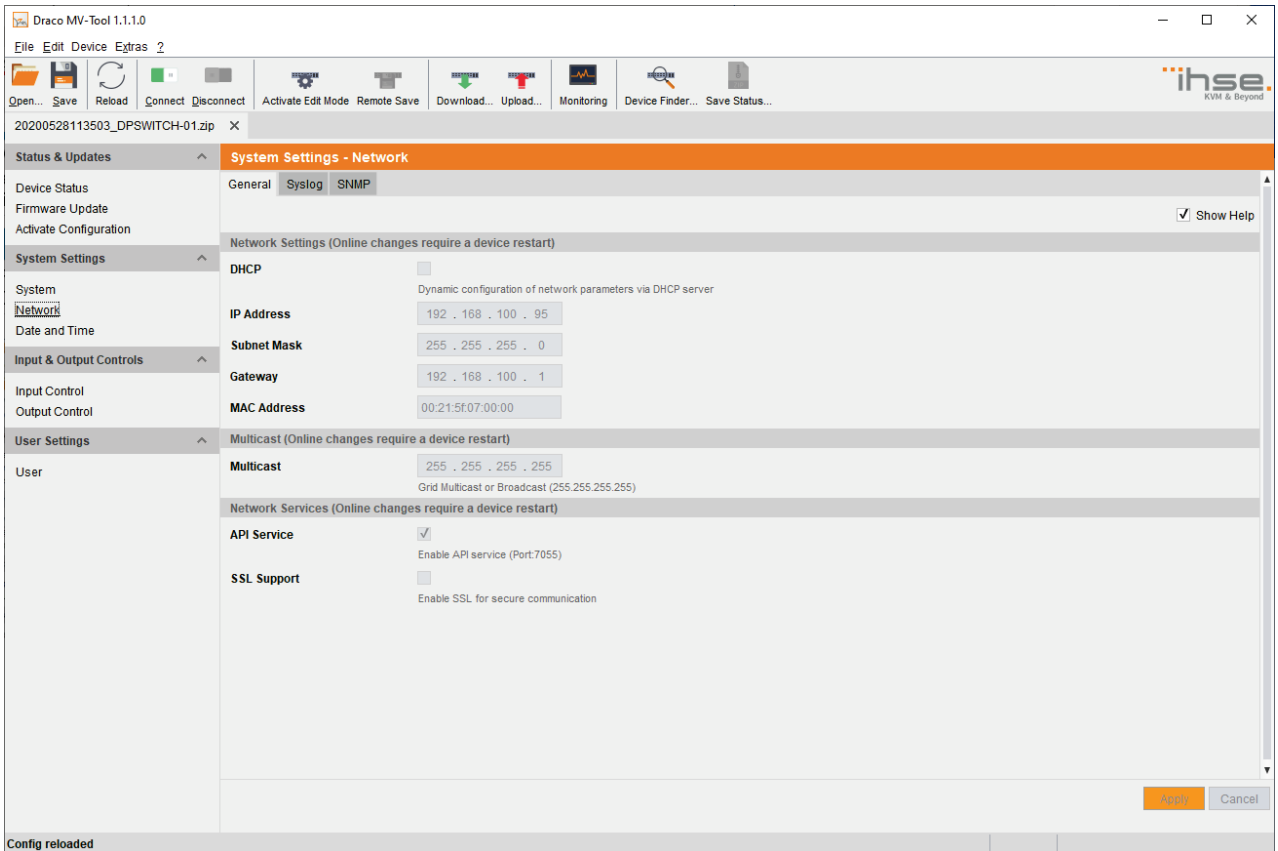

Fig. 70 Menu **Status & Updates - Network**



For information about the parameters, please refer to chapter 6.3.2, page 65.

7.4.3 Firmware Status

The current firmware status is displayed in this menu.

➔ Select **Status & Updates > Firmware Update** in the task area, to query the current firmware status.

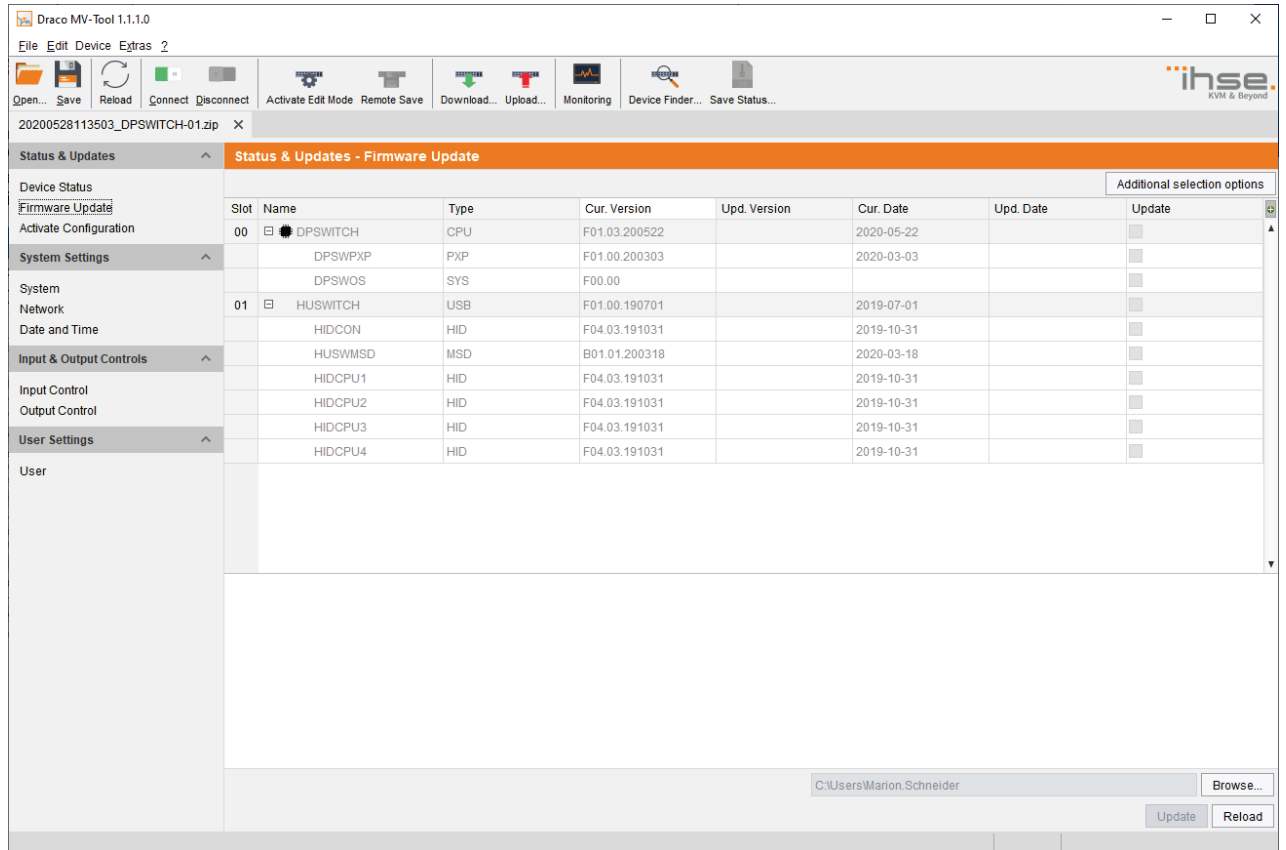

Fig. 71 Menu **Status & Updates - Firmware Update**

7.4.4 Syslog Monitoring

The syslog function offers a complete logging of the Draco MV activities and switching operations in this menu. During logging the activities are written continuously into logging files and stored locally.

NOTICE

Syslog messages are transmitted via UDP. Therefore, port 514 within the used network should not be blocked, e.g. by a firewall.



The procedure for activating the syslog function is described in chapter 6.3.3, page 67.

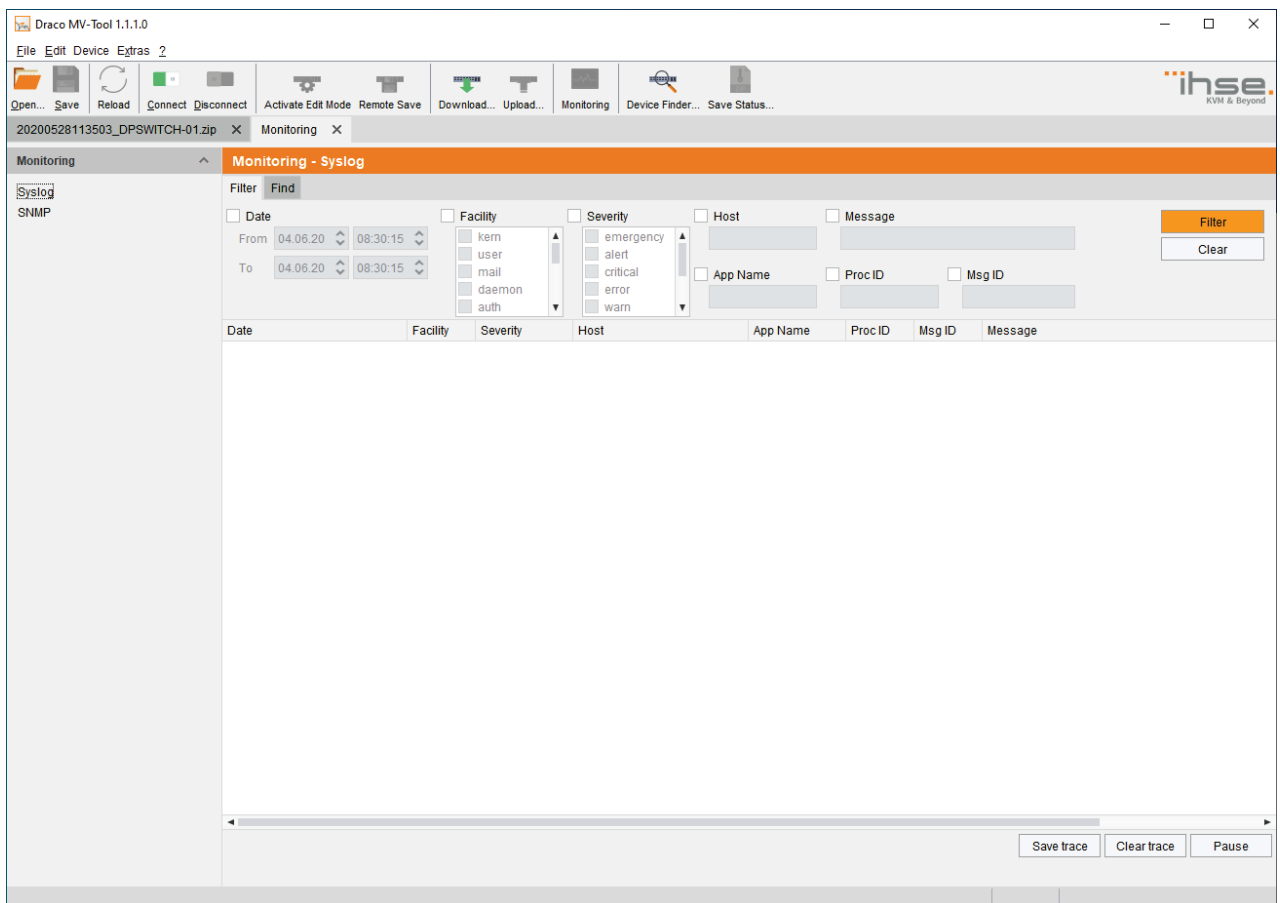

Fig. 72 Menu **Monitoring - Syslog**

To start syslog monitoring, proceed as follows:

➔ Click the **Monitoring** menu item in the toolbar.

In the working area the configuration menu for the syslog monitoring is opened.

Filter function

To filter relevant messages out of a number of logged activities of the Draco MV, the syslog monitoring offers various filter options.

To set and activate a filter, proceed as follows:

1. Activate the respective checkbox(es) to activate the desired filter option(s).
2. Click the **Filter** button to activate the filter settings.
3. Click the **Clear** button to deactivate an activated filter setting.

The following filter options are available:

Option	Description
Date	Messages for a defined date range will be filtered
Facility	Messages for a defined facility will be filtered
Severity	Messages for a defined severity will be filtered
Host	Messages for a defined host will be filtered
Message	Messages with defined text parts will be filtered



Filter options are not valid within the locally stored log files.

Recording function

All messages shown in the syslog logging are equipped with various recording functions.

- ➔ Click the **Save trace** button to store recorded messages (filtered or unfiltered). The messages will be stored in a .txt file.
- ➔ Click the **Clear trace** button to remove recorded messages.
- ➔ Click the **Pause** button to stop recording messages. Click the **Pause** button again to continue recording messages.

7.4.5 SNMP Monitoring

The SNMP function allows all function-critical and safety-critical elements of the Draco MV to be monitored and queried. This function complies with the RFC 1157 conformal standard.

NOTICE

When using SNMP monitoring, for reasons of access security, the use of a dedicated network according to the IT-Grundschutz catalog is recommended. The read only community for the MIB file is **draco**.



The procedure for activating the SNMP agent or configuring a SNMP server is described in chapter 6.3.4, page 70.

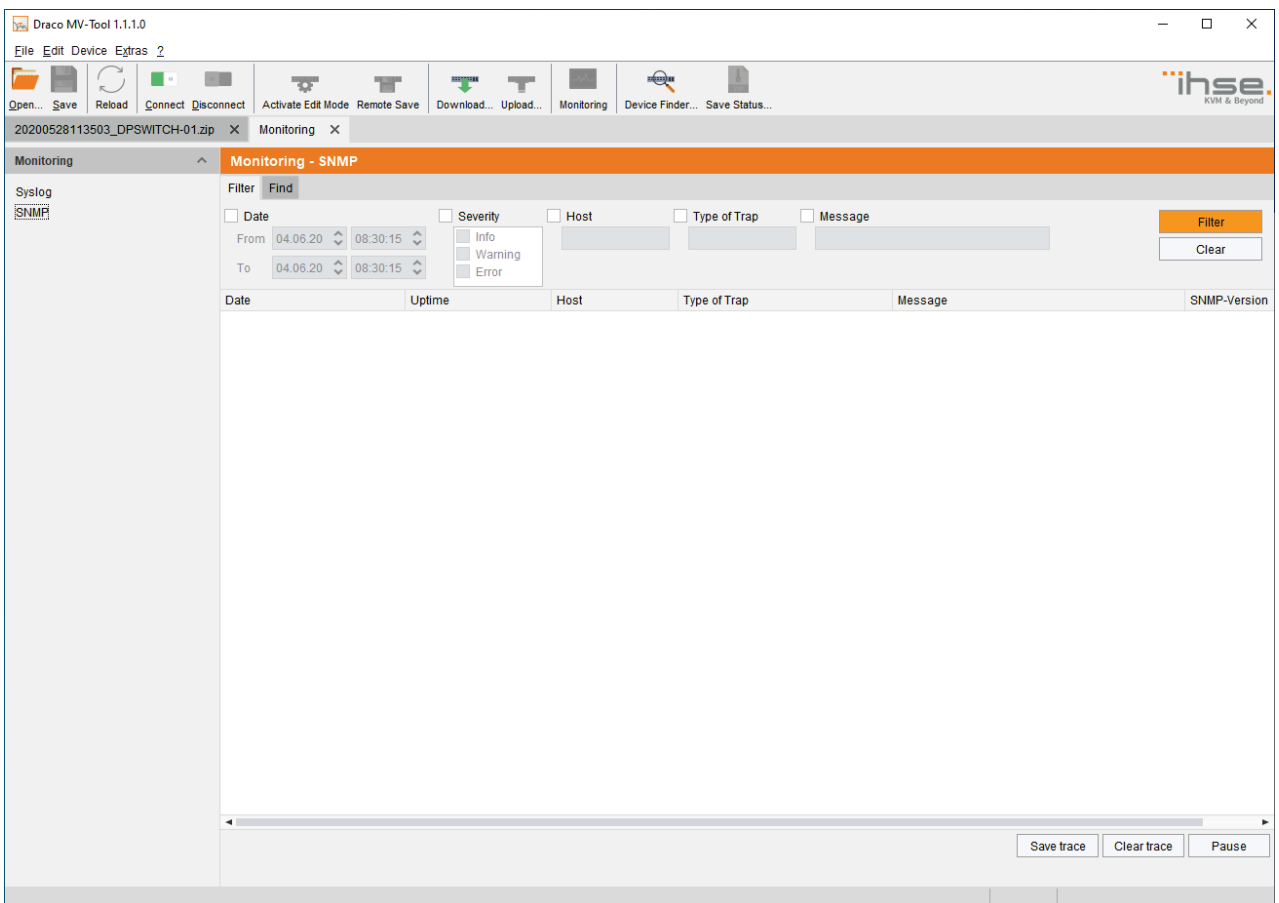

Fig. 73 Menu **Monitoring - SNMP**

To open the SNMP monitoring, proceed as follows:

➔ Click the **Monitoring** menu item in the toolbar.

In the working area the logging overview for the SNMP monitoring is displayed.

Filter function

To filter relevant messages out of a number of logged activities of the Draco MV, the SNMP monitoring offers various filter options.

To set and activate a filter, proceed as follows:

1. Activate the respective checkbox(es) to activate the desired filter option(s).
2. Click the **Filter** button to activate the filter settings.
3. Click the **Clear** button to deactivate an activated filter setting.

The following filter options are available:

Option	Description
Date	Messages for a defined date range will be filtered
Facility	Messages for a defined facility will be filtered
Severity	Messages for a defined severity will be filtered
Host	Messages for a defined host will be filtered
Message	Messages with defined text parts will be filtered



Filter options are not valid within the locally stored log files.

Recording function

All messages shown in the SNMP are equipped with various recording functions.

- ➔ Click the **Save trace** button to store recorded messages (filtered or unfiltered). The messages will be stored in a .txt file.
- ➔ Click the **Clear trace** button to remove recorded messages.
- ➔ Click the **Pause** button to stop recording messages. Click the **Pause** button again to continue recording messages.

7.5 Saving Status via Management Software

1. Click the **Save Status** menu item in the toolbar to read out the overall status of the Draco MV and store it locally (file extension **.zip**).

An access window appears.

2. Enter the IP address of the Draco MV in the entry field.
3. Enter the name and password of the administrator.
4. Click the **Next** button.

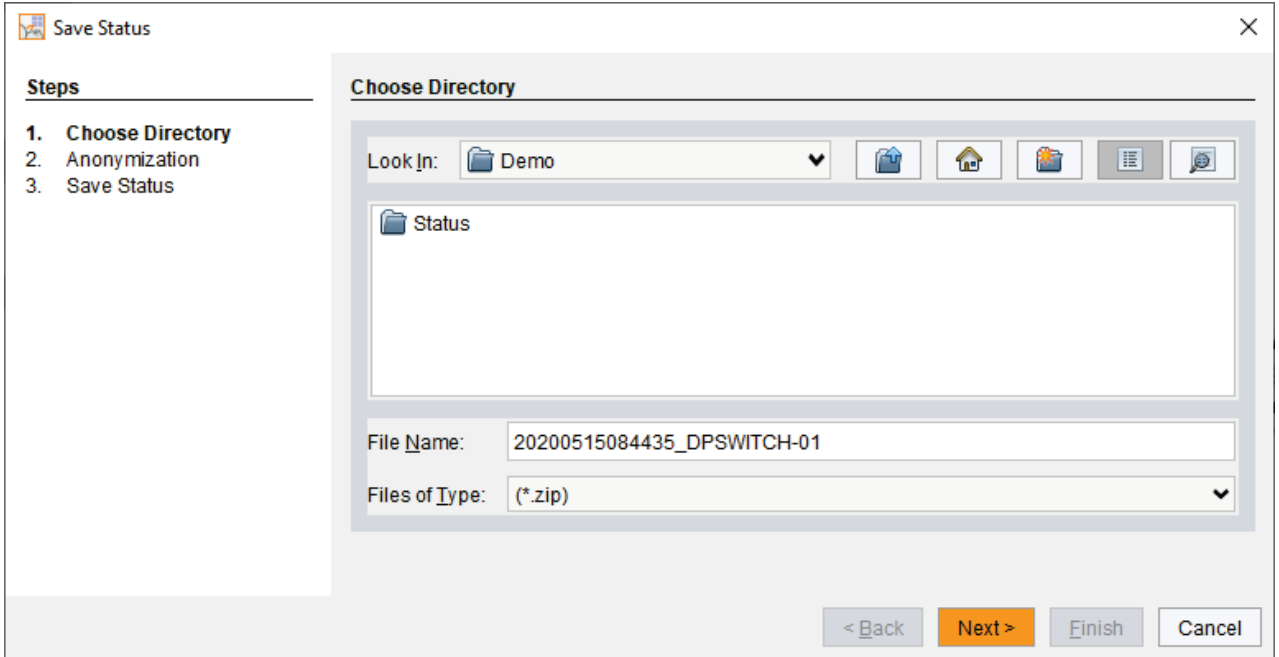

Fig. 74 Menu Save Status - Choose Directory

5. Activate the checkbox to anonymize your personal data when saving the status file.
6. Click the **Finish** button to save the status file.

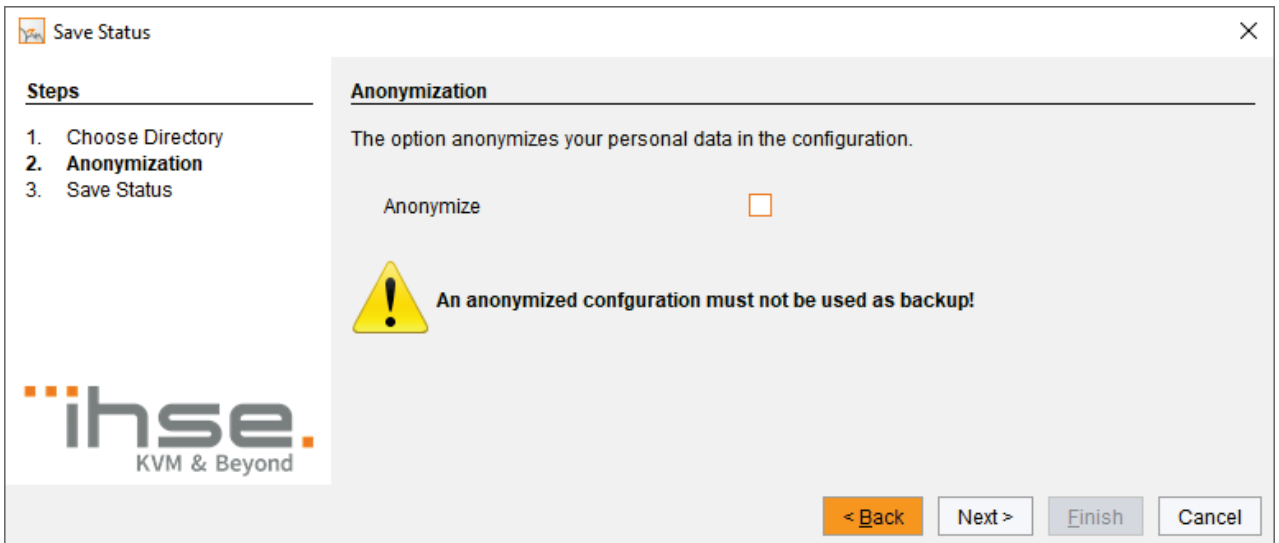

Fig. 75 Menu Save Status - Anonymization

7.6 Opening Locally Saved Status via Management Software

To load a locally saved status, proceed as follows:

1. Select **Device > Load Status...** in the menu bar.
2. Navigate to the location of the status file to be opened.
3. Click the status file to be opened.
4. Click the **Open** button, to open the status file.

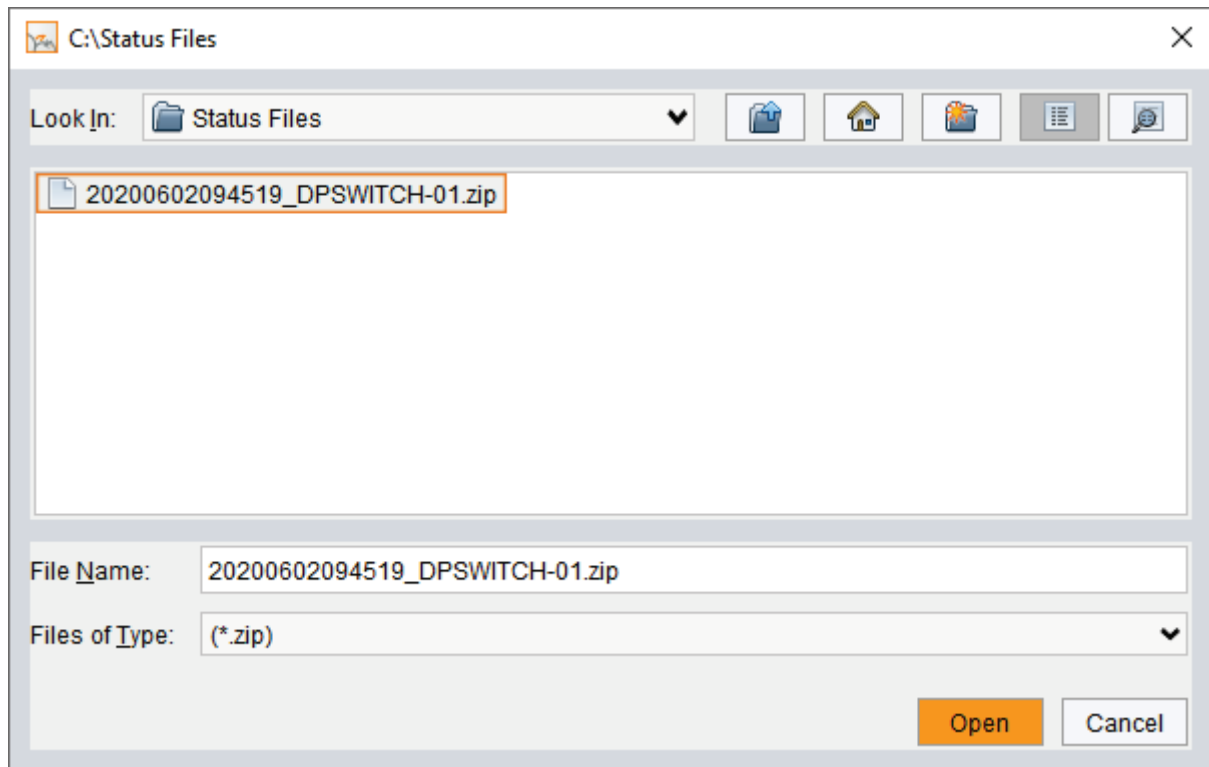

Fig. 76 Menu **Device - Load Status**



The status can also be opened via drag & drop. To do this, click on the status file, hold the mouse button down and drag the status file into the management software.

7.7 Updating Firmware via Service Port

The firmware of the Draco MV can be updated via service port. To perform an update, proceed as follows:

1. Remove all USB cables from the CPU ports of the Draco MV.
2. Connect from a computer to the Draco MV via mini USB cable.
As a result, the Draco MV will open a flash drive.
3. Copy the provided firmware files to the Draco MV. You do not have to adhere to a special sequence.
4. Before putting the Draco MV into operation again, you have to reconnect to USB cables to the Draco MV with the power switched off.
5. Restart the Draco MV (see chapter 7.9.2, page 104).

7.8 Updating Firmware via Management Software

NOTICE

Only use computers to update the Draco MV that are not integrated into the Draco MV setup. Ensure that the computer used for the update is not set into standby mode or sleep mode during the update.

Ensure that your configuration has been saved locally before you start the update.

For reasons of network stability, an update via WLAN is not recommended.

The firmware of the Draco MV can be updated in this menu.

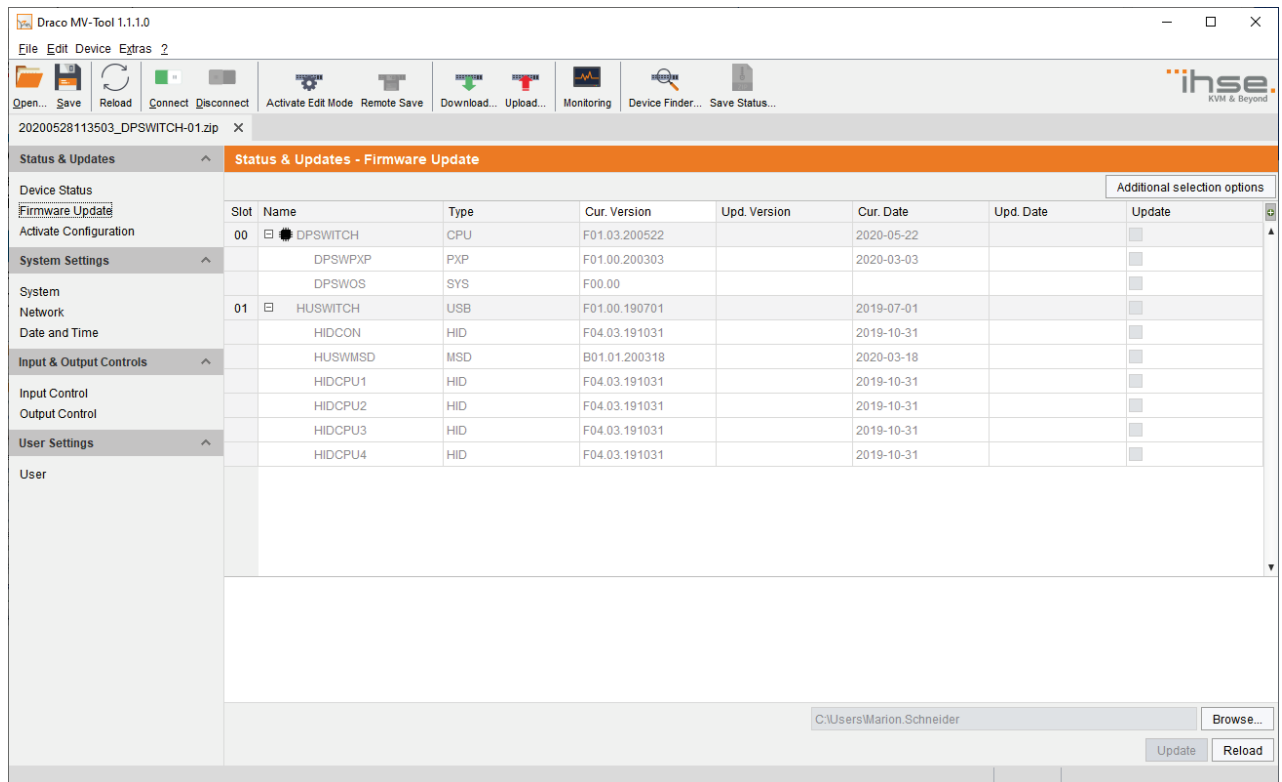

Fig. 77 Menu **Status & Updates - Firmware Update**

Preparation



If the syslog function has not been set yet, we recommend activating the syslog function (see chapter 6.3.3, page 67) before updating the firmware to log the update in case of update errors

To be prepared for a firmware update, proceed as follows:

1. Save the Draco MV configuration locally (see chapter 6.6.3, page 83).
2. If the options settings for the management software have not yet been set: open **Extras > Options** in the menu bar and insert in under **Firmware Directory** the directory from which the update files should be standardly sourced.

Update

To update the firmware of the Draco MV, proceed as follows:

1. Select **Status & Updates > Firmware Update** in the task area.

All updateable components of the Draco MV will be automatically selected and highlighted in green.

2. Click the **Update** button in the lower part of the working area, to start the update.

After the update, a query to restart the Draco MV appears.

3. Click the **Restart** button to restart the Draco MV.

7.9 Power On and Power Down Functions via OSD

7.9.1 Power Down Draco MV

To shut down the Draco MV, proceed as follows:

→ Select **Configuration > Shut down MV** in the main menu.

The current configuration is saved in the permanent memory of the Draco MV and the Draco MV will be shut down.

NOTICE

After shutting down, the Draco MV can be disconnected from the power supply.

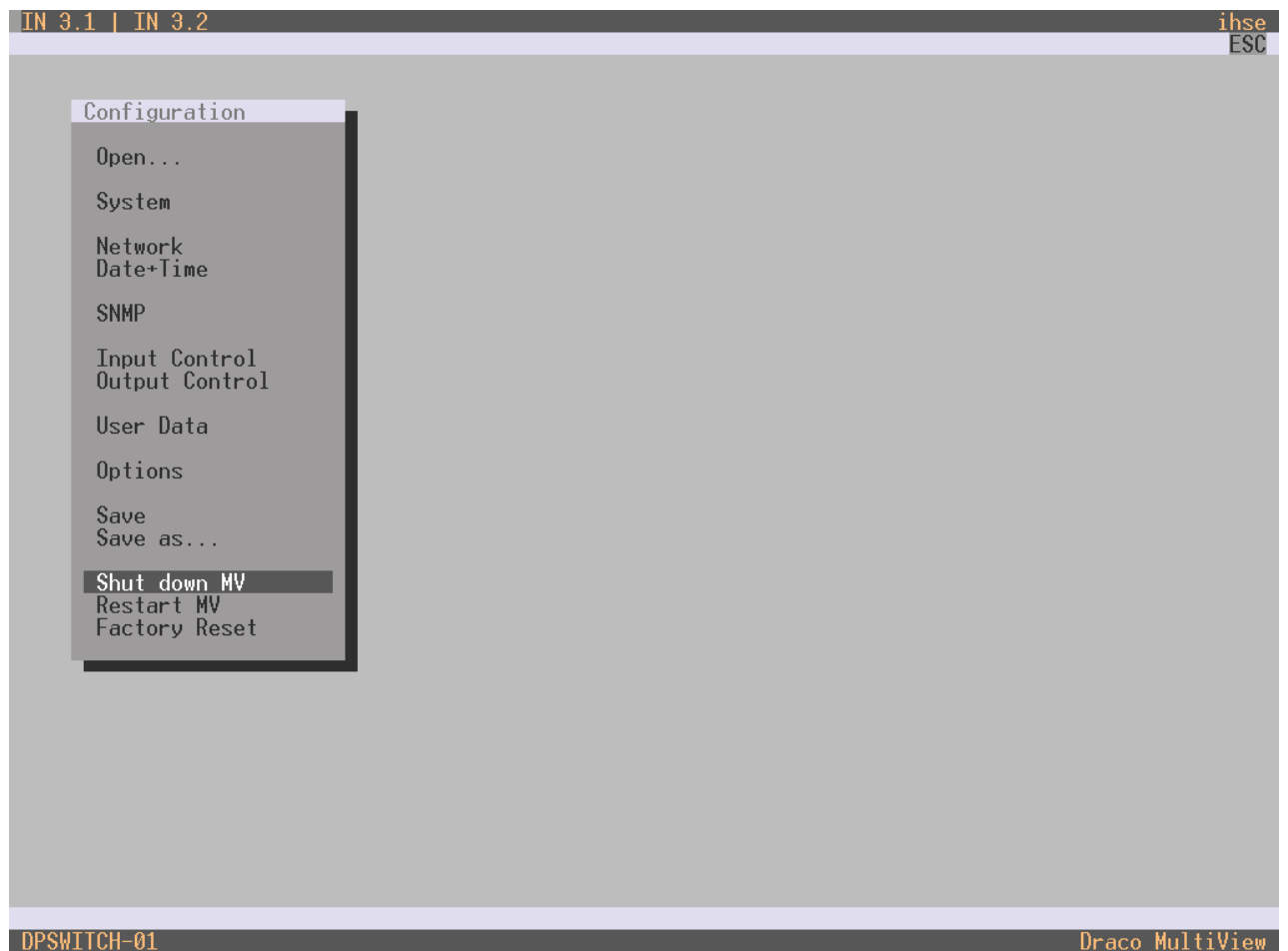

Fig. 78 Menu Configuration - Shut down MV

7.9.2 Restart MV

To perform a restart of the Draco MV, proceed as follows:

➔ Select **Configuration > Restart MV** in the main menu.

The current configuration is saved in the permanent memory of the Draco MV and the Draco MV will be restarted with the current configuration.

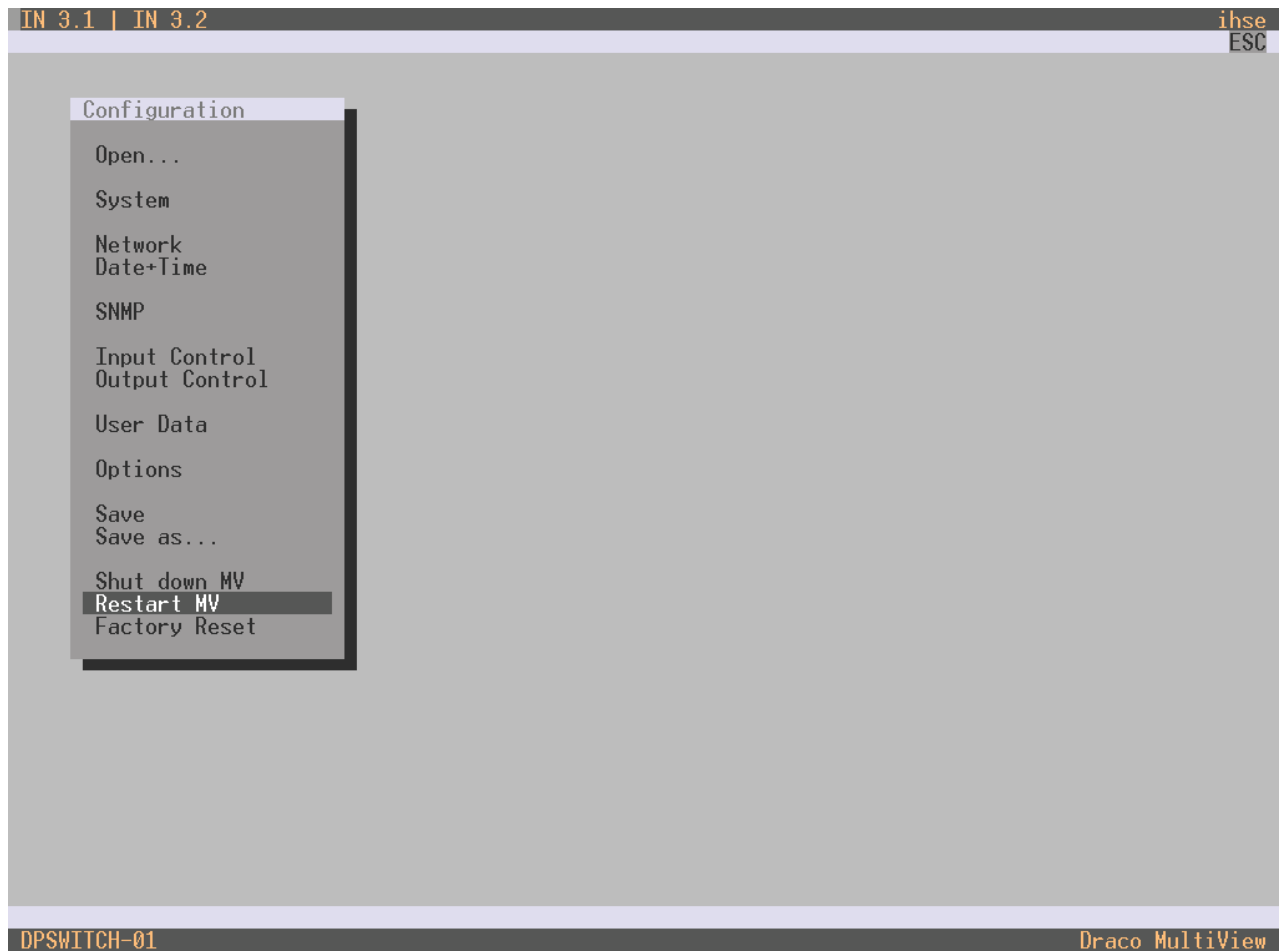

Fig. 79 Menu Configuration - Restart MV

7.9.3 Factory Reset

NOTICE

If you perform a (factory) reset, all current settings and all configurations stored in the Draco MV will be lost. This also applies to the network parameters (reset to DHCP) and the admin password.

Any firmware update that may have been carried out since the delivery is not affected, the current firmware version is retained

To perform a reset of the Draco MV to the factory settings, proceed as follows:

➔ Select **Configuration > Factory Reset** in the main menu.

The current configuration in the memory of the Draco MV is deleted and the Draco MV is reset to the factory settings.

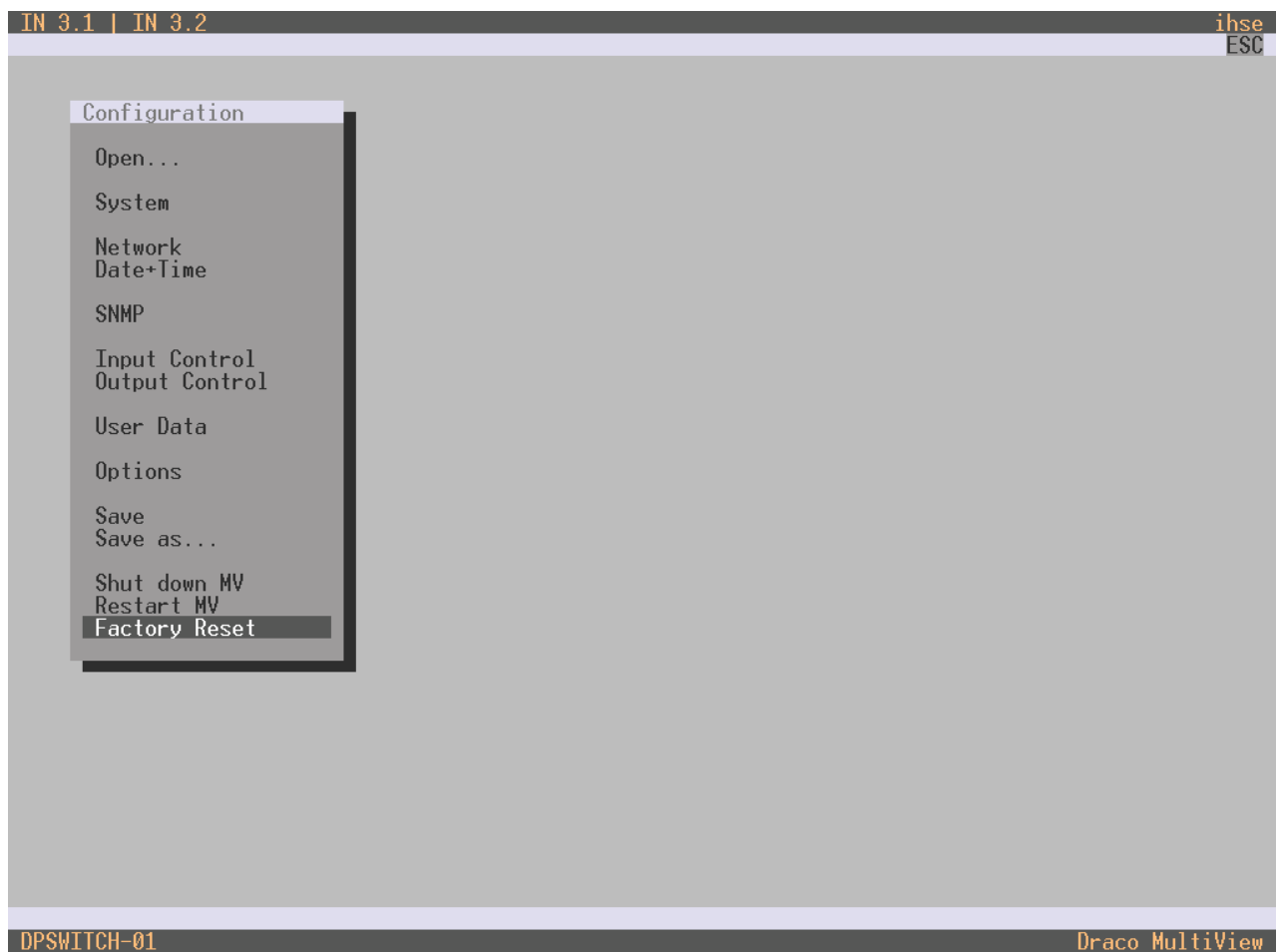

Fig. 80 Menu **Factory Reset**

7.10 Power On and Power Down Functions via Management Software

7.10.1 Power Down Draco MV

NOTICE

After shutting down, the Draco MV can be disconnected from the power supply.

To shut down the Draco MV, proceed as follows:

1. Select **Device > Advanced Service > Shut down Device** in the menu bar.
An access window appears.
2. Enter the username and password of the administrator.
3. Click the **Ok** button.

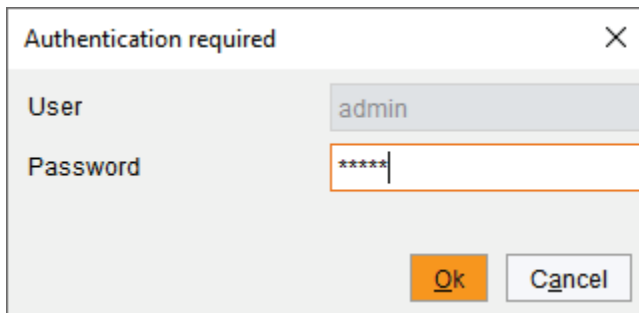

Fig. 81 Administrator access window

A query to shut down the Draco MV appears.

4. Click the **Yes** button to start the shutdown.

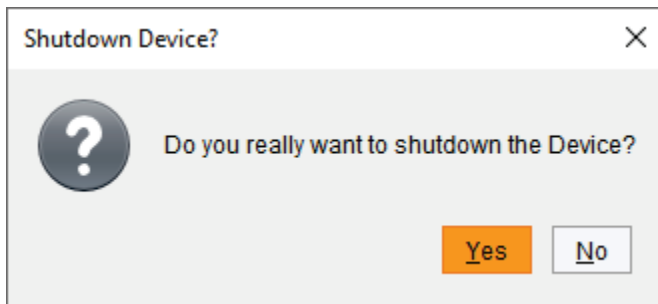

Fig. 82 Query window for shut down

The current configuration is saved in the permanent memory of the Draco MV and the Draco MV will be shut down.

After shutting down, a notification to power off the Draco MV appears.

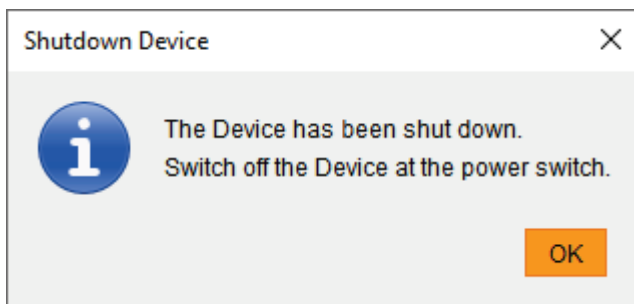

Fig. 83 Notification window for shut down

7.10.2 Restart MV

NOTICE

When restarting the Draco MV, the current configuration is saved in the permanent memory of the Draco MV and the Draco MV will be restarted with the active configuration.

To perform a restart of the Draco MV, proceed as follows:

1. Select **Device > Advanced Service > Restart Device** in the menu bar.
An access window appears.
2. Enter the username and password of the administrator.
3. Click the **Ok** button.

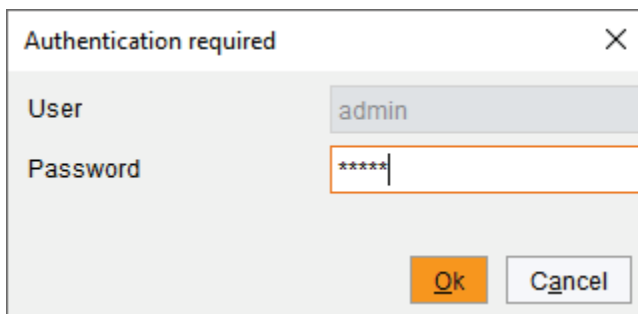

Fig. 84 Administrator access window

A query to restart the Draco MV appears.

4. Click the **Yes** button to restart the Draco MV.

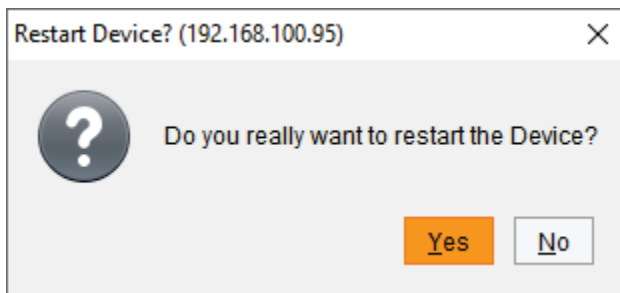

Fig. 85 Query window for restart

The current configuration is saved in the permanent memory of the Draco MV and the Draco MV will be restarted.

7.10.3 Factory Reset

NOTICE

If you perform a (factory) reset, all current settings and all configurations stored in the Draco MV will be lost. This also applies to the network parameters (reset to DHCP) and the admin password.

NOTICE

If a firmware update has been carried out since the delivery, this firmware version is retained.

To perform a reset of the Draco MV, proceed as follows:

1. Select **Device > Advanced Service > Factory Reset** in the menu bar.
An access window appears.
2. Enter the username and password of the administrator.
3. Click the **Ok** button to confirm your entries.

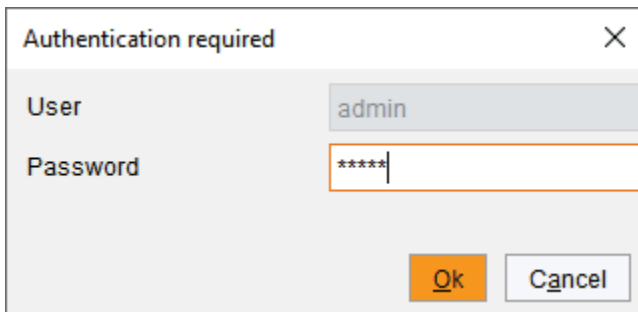

The screenshot shows a dialog box titled "Authentication required" with a close button (X) in the top right corner. It contains two input fields: "User" with the text "admin" and "Password" with masked characters "*****". At the bottom right, there are two buttons: "Ok" (highlighted in orange) and "Cancel".

Fig. 86 Administrator access window

A query to reset the Draco MV appears.

4. Click the **Yes** button to reset the device.

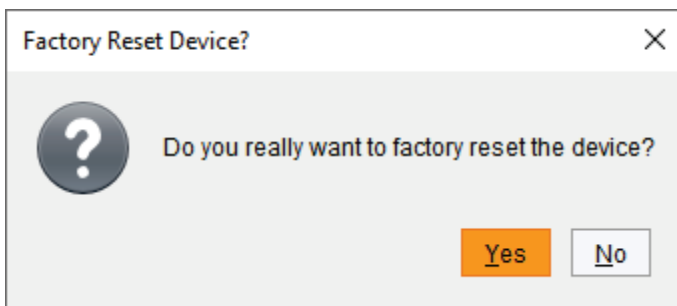

The screenshot shows a dialog box titled "Factory Reset Device?" with a close button (X) in the top right corner. It features a question mark icon on the left and the text "Do you really want to factory reset the device?". At the bottom right, there are two buttons: "Yes" (highlighted in orange) and "No".

Fig. 87 Query window

The Draco MV will be reset to factory settings.

8 Specifications

8.1 Interfaces

8.1.1 DisplayPort

Upstream/Downstream

The pins of the DisplayPort sockets are assigned differently.

Upstream: data is sent (e.g. source, graphics card, video output of a device)

Downstream: data is received (e.g. sink, monitor, video input of a device)

Video

The video interface supports the DisplayPort 1.2 standard. All signals that comply with this standard can be transmitted. This includes monitor resolutions up to 4096x2160@60Hz (4K DCI) or 3840x2160@60Hz (UHD). Data rate is limited to 21.6 Gbit/s. The color depth is 8 bit (4:4:4).

Audio

Various audio formats can be transmitted through the interface.

Parameters	Values
Standards	Stereo Linear Pulse Code Modulation (LPCM)
Bit depth	16 to 24 bit
Sample-Rate	32 to 48 kHz

8.1.2 HDMI

Video

The video interface supports the HDMI 2.0 standard. All signals that comply with this standard can be transmitted. This includes monitor resolutions up to 4096x2160@60Hz (4K DCI) or 3840x2160@60Hz (UHD). Data rate is limited to 18 Gbit/s. The color depth is 8 bit (4:4:4).

Audio

Various audio formats can be transmitted through the interface.

Parameters	Values
Standards	Stereo Linear Pulse Code Modulation (LPCM)
Bit depth	16 to 24 bit
Sample-Rate	32 to 48 kHz

8.1.3 USB-HID

Our devices with USB-HID interface support a maximum of two devices with USB-HID protocol. Each USB-HID port provides a maximum current of 100 mA.

Keyboard

Compatible with most USB keyboards. Certain keyboards with additional functions may require custom firmware to operate. Keyboards with an integral USB Hub (Mac keyboards e.g.) are also supported, however, a maximum of two devices are supported.

Mouse

Compatible with most 2-button, 3-button and scroll mice.

Other USB-HID devices

The proprietary USB emulation supports certain other USB-HID devices, such as specific touch screens, graphic tablets, barcode scanners or special keyboards. However, support cannot be guaranteed for every USB-HID device.

Extension

If it is required to extend the USB-HID signals on CPU or console side (e.g. mounting requirement), the signals can be extended either via a 3.0 m A-B cable (247-U2) or a 3.0 m USB A-A extension cable (436-USB20). The compatibility to other extension cables cannot be guaranteed.

 Only two USB-HID devices are supported concurrently, such as keyboard and mouse or keyboard and touch screen. A hub is allowed, but it does not increase the number of devices allowed.

To support other USB 'non-HID' devices, such as scanners, web cams or memory devices, use the USB 2.0 interfaces.

8.1.4 USB 2.0 (transparent)

The Draco MV with transparent USB 2.0 interface supports all types of USB 2.0 devices (without restriction). USB 2.0 data transfer is supported with USB high speed (max. 480 Mbit/s).

Each USB 2.0 interface provides a maximum current of 500 mA (high power), however, with the MV42-DPDH a maximum current of 100 mA per USB 2.0 interface will be provided.

NOTICE

The following applies to the MV42-DPDH:

When connecting 2 USB-HID devices and 2 USB-2.0 devices, a maximum current of 400 mA will be provided.

8.1.5 Mini-USB

This interface enables a customer specified communication with the Draco MV. The firmware could also be updated using this interface.

8.1.6 GPIO Port

An external keypad with up to four buttons, each of which one associated LED can be connected to this interface. After pressing a button, the corresponding source is switched. The switching carried out is indicated on the associated LED. E.g. button 1 is assigned to the USB-B port for source 1. Max. 50 mA is supplied at the port for the power supply.

8.1.7 RJ45 (Interconnect)

Communication between Cat X devices requires a 1000BASE-T connection.

Connector wiring must comply with EIA/TIA-568-B (1000BASE-T), with RJ45 connectors at both ends. All four cable wire pairs are used

8.1.8 3,5 mm Audio Interface (Optical Digital / Analog)

The Draco MV with optical-digital audio interface supports the unidirectional transmission of digital audio data. This is a combined interface that can output both digital and analog. The output can be either digital or analog at any moment.

Up to four sources can be connected to the Draco MV. The audio data of all sources will be transmitted to the Draco MV at the same time, but only the audio signal of the active source will be provided at the audio output.

Specifications digital audio

Parameters	Values
Compatibility	S/PDIF, EIAJ RC-5720B, JIS C 6560
Standards	PCM
Bit depth	24 bit
Sample-Rate	32 to 96 kHz
Connection	<ul style="list-style-type: none"> Coaxial (S/PDIF; Cinch) Optical (S/PDIF)

Specifications analog-audio

Parameters	Values
Standards	Digitized virtually CD quality audio
Bit depth	24 bit
Sample-Rate	Up to 192 kHz
Signal Level	Line-Level (5 Volt Pk-Pk maximum)
Connection	2x 3.5 mm stereo jack plug (audio output)

8.2 Connector Pinouts

8.2.1 DisplayPort - Upstream

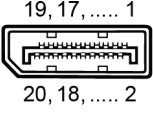
Connector	Pin	Signal	Pin	Signal
	1	ML_Lane 0 (p)	11	GND
	2	GND	12	ML-LANE 3 (n)
	3	ML_Lane 0 (n)	13	Config1/GND
	4	ML_Lane 1 (p)	14	Config2/GND
	5	GND	15	AUX CH (p)
	6	ML_Lane 1 (n)	16	GND
	7	ML_Lane 2 (p)	17	AUX CH (n)
	8	GND	18	Hot Plug Detect
	9	ML_Lane 2 (n)	19	Power Out Return
	10	ML_Lane 3 (p)	20	Power out (+3.3 V / 0.5 A)

8.2.2 DisplayPort - Downstream

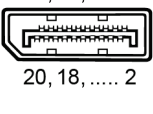
Connector	Pin	Signal	Pin	Signal
	1	ML_Lane 3 (n)	11	GND
	2	GND	12	ML-LANE 0 (p)
	3	ML_Lane 3 (p)	13	Config1/GND
	4	ML_Lane 2 (n)	14	Config2/GND
	5	GND	15	AUX CH (p)
	6	ML_Lane 2 (p)	16	GND
	7	ML_Lane 1 (n)	17	AUX CH (n)
	8	GND	18	Hot Plug Detect
	9	ML_Lane 1 (p)	19	Power Out Return
	10	ML_Lane 0 (n)	20	Not connected

8.2.3 HDMI

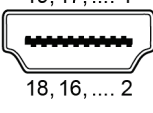
Connector	Pin	Signal	Pin	Signal
	1	TMDS data 2+	11	TMDS clock GND
	2	TMDS data 2 GND	12	TMDS clock-
	3	TMDS data 2-	13	CEC
	4	TMDS data 1+	14	Not connected
	5	TMDS data 1 GND	15	DDC Input (SCL)
	6	TMDS data 1-	16	DDC Output (SDA)
	7	TMDS data 0+	17	DDC/CEC/HEC GND
	8	TMDS data 0 GND	18	+5 V (DC) high impedance
	9	TMDS data 0-	19	Hot Plug recognition
	10	TMDS clock+	-	-

8.2.4 USB, Type A

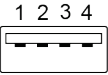
Connector	Pin	Signal	Color
	1	+5 V (DC)	Red
	2	D -	White
	3	D +	Green
	4	GND	Black

8.2.5 USB, Type B

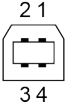
Connector	Pin	Signal	Color
	1	+5 V (DC)	Red
	2	D -	White
	3	D +	Green
	4	GND	Black

8.2.6 Mini-USB, Type B

Connector	Pin	Signal	Color
	1	+5 V (DC)	Red
	2	Data -	White
	3	Data +	Green
	4	Not connected	-
	5	GND	Black

8.2.7 D-Sub 9 (GPIO)

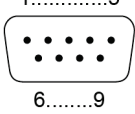
Connector	Pin	Signal	Control
	1	GPIO1	LED 1
	2	GPIO2	Push button 1
	3	+5 V (DC)	
	4	GPIO3	LED 2
	5	GPIO4	Push button 2
	6	GPIO5	LED 3
	7	GPIO5	Push button 3
	8	GPIO7	LED 4
	9	GPIO8	Push button 4

8.2.8 Mini-Toslink

Connector	Pin	Signal	Pin	Signal
	1	GND	3	Audio OUT R
	2	Audio OUT L	4	Audio OUT optical digital / analog

8.2.9 RJ45 (Interconnect)

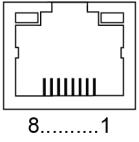
Connector	Pin	Signal	Pin	Signal
	1	D1+	5	D3-
	2	D1-	6	D2-
	3	D2+	7	D4+
	4	D3+	8	D4-

8.3 Power Supply and Power Consumption

Product type	Maximum current	Maximum voltage (AC)	Frequency	Power consumption
MV42-DPSH	700 mA	100 to 240 V	50/60 Hz	38 W
MV42-DPDH*	700 mA	100 to 240 V	50/60 Hz	50 W*
MV42-H2SH	700 mA	100 to 240 V	50/60 Hz	29 W
MV42-H2DH	700 mA	100 to 240 V	50/60 Hz	44 W

* With MV42-DPDH, the maximum power consumption is 100 mA per USB device, a total of max. of 400 mA current consumption.

8.4 Environmental Conditions and Emissions

Parameters	Values
Operating Temperature	5 to 45 °C (41 to 113 °F)
Storage Temperature	-25 to 60 °C (-13 to 140 °F)
Relative Humidity	max. 80% non-condensing
Operating Altitude	max. 2.500 m (7,500 ft)
Heat Dissipation	Corresponds to power consumption in Watt (W)

8.5 Dimensions

Product/ Packaging	Dimensions
MV42-DPSH	442 x 250 x 44 mm (17.4" x 9.8" x 1.7")
MV42-H2SH	
MV42-DPDH	
MV42-H2DH	
Shipping box	550 x 372 x 155 mm (21.7" x 14.6" x 6.1")

8.6 Weight

Product	Weight	Weight incl. shipping box
MV42-DPSH	3,9 kg (8.6 lb)	6,15 kg (13.6 lb)
MV42-H2SH	3,9 kg (8.6 lb)	6,15 kg (13.6 lb)
MV42-DPDH	4,8 kg (10.6 lb)	7,1 kg (15.7 lb)
MV42-H2DH	4,8 kg (10.6 lb)	7,1 kg (15.7 lb)

8.7 MTBF

The following table contains the mean time between failure (MTBF) in power-on hours (POH). The estimate is based on the FIT rates of the parts included. FIT rates are based on normalized environmental conditions of $T = 60^{\circ}\text{C}$ and activation energy (E_a) of 0.7 eV. Calculations are based on 90% confidence limit.

We estimate that inside the housing, temperature will be 15°C higher than the ambient temperature. Therefore, the MTBF calculation refers to an ambient temperature of 45°C . The humidity is limited to 60%.

Product	MTBF in POH
MV42-DPSH	67,232
MV42-H2SH	48,480
MV42-DPDH	72,283
MV42-H2DH	53,913

9 Maintenance

The Draco MV contains no user serviceable parts inside.

- Do not attempt to open or repair the device.
- Please contact your dealer or manufacturer if there is a fault.

10 Troubleshooting

In the following chapters, support for issues with the Draco MV is provided. Please ensure before operating the Draco MV that the Draco MV is connected over a peer-to-peer connection.



If using the Draco MV with KVM extenders or a KVM matrix switch, please refer to the relevant manuals for assistance if there is an issue

10.1 Network Error

Diagnosis	Possible reason	Measure
Network settings are not assumed after editing.	Restart of the Draco MV not yet completed.	→ Restart the Draco MV.

10.2 Failure at the Draco MV

Diagnosis	Possible reason	Measure
Opening the OSD not possible	Wrong 'Hot Key'	→ Reset 'Hot Key' if necessary (see chapter 3.8.1, from page 26)

10.3 Failure at the USB-HID Port

Diagnosis	Possible reason	Measure
Caps Lock and Scroll Lock LEDs on the keyboard are flashing	Keyboard in command mode	→ Press <code><Esc></code> key to leave the command mode
USB device without function	No USB-HID device recognized	→ Connect a USB-HID device.
	USB-HID device is not supported	→ Check the compatibility. → Contact your dealer if necessary.

10.4 Video Interference

Diagnosis	Possible reason	Measure
Incorrect video display	Cable connection disturbed	→ Check the integrity of the video cable. → Reboot of source (computer, CPU).

10.5 Blank Screen

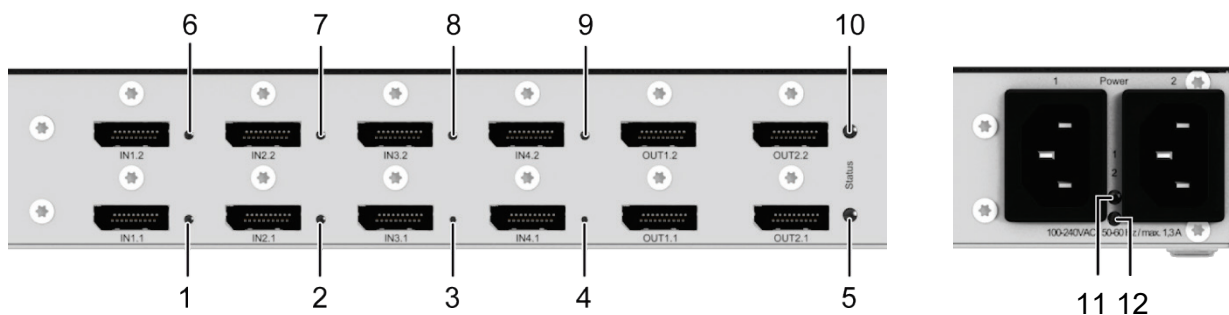

Fig. 88 Connection side

Diagnosis	Possible reason	Measure
LED 11 and LED 12 off	Power supply	➔ Check the connection to the power network.
Monitors remains dark after switching operation	Switching to a port without active source (computer, CPU).	➔ Switching to a port with an active source.
One LED of the LEDs 1 to 4 or 6 to 9 is off	Source not connected.	➔ Check cable connectivity between source and Draco MV.

11 Technical Support

Prior to contacting support please ensure you have read this manual, and then installed and set-up your Draco MV as recommended.

11.1 Support Checklist

To efficiently handle your request, it is necessary that you complete a support request checklist ([Download](#)). Please ensure that you have the following information available before you call:

- Company, name, phone number and email
- Type and serial number of the device (see bottom of the device)
- Date and number of sales receipt and name of dealer if necessary
- Issue date of the existing manual
- Nature, circumstances and duration of the problem
- Components included in the system (such as graphic source/CPU, OS, graphic card, monitor, USB-HID/USB 2.0 devices, interconnect cable) including manufacturer and model number
- Results from any testing you have done

11.2 Shipping Checklist

1. To return your device, you need an RMA number (Return-Material-Authorization). Therefore, please contact your dealer.
2. Package your devices carefully. Add all pieces which you received originally. Preferably use the original box.
3. Note your RMA number visibly on your shipment.



Devices that are sent in without an RMA number will not be accepted. The shipment will be sent back without being opened; postage unpaid.

12 Certificates/Directives

12.1 North American Regulatory Compliance

This equipment has been found to comply with the limits for a Class A digital device, pursuant to Part 15 of the FCC Rules. These limits are designed to provide reasonable protection against harmful interference when the equipment is operated in a commercial environment. This equipment generates, uses, and can radiate radio frequency energy and, if not installed and used in accordance with the instruction manual, may cause harmful interference to radio communications. Operation of this equipment in a residential area is likely to cause harmful interference in which case the user will be required to correct the interference at his own expense. Changes or modifications not expressly approved by the party responsible for compliance could void the user's authority to operate the equipment.

Shielded cables must be used with this equipment to maintain compliance with radio frequency energy emission regulations and ensure a suitably high level of immunity to electromagnetic disturbances.

All power supplies are certified to the relevant major international safety standards.

12.2 WEEE

The manufacturer complies with the EU Directive 2012/19/EU on the prevention of waste electrical and electronic equipment (WEEE).

The device labels carry a respective marking.

12.3 RoHS

This device complies with the Directive 2011/65/EU of the European Parliament and of the council of 8 June 2011 on the restriction of the use of certain hazardous substances in electrical and electronic equipment (including the Commission Delegated Directive (EU) 2015/853 of 31 March 2015 amending Annex II to Directive 2011/65/EU).

The device labels carry a respective marking.

13 EU Declaration of Conformity

We as manufacturer hereby declare under our sole responsibility that the products listed below comply with the essential requirements which are determined in the following harmonization regulations described below:

Manufacturer IHSE GmbH
Benzstraße 1
88094 Oberteuringen
Deutschland

Product Draco MultiView 4K₆₀
Product series MV42

2014/30/EU Council Directive on the approximation of the laws of the Member States relating to electromagnetic compatibility.
2014/35/EU Council Directive on the harmonization of the laws of the Member States relating to the making available on the market of electrical equipment designed for use within certain voltage limits.
2011/65/EU Council Directive on the restriction of the use of certain hazardous substances in electrical and electronic equipment.

Compliance with the directives is verified by compliance with the following standards:

EN 55032:2015
EN 55024:2010 + A1:2015
EN 61000-3-2:2019
EN 61000-3-3:2013
EN 61000-6-2:2019
EN 62368-1:2014 + AC:2015
EN 63000:2019-05

Oberteuringen, May 15, 2020

Place, Date



Managing Director, Dr. Enno Littmann

This declaration certifies the compliance with the mentioned directives but does not include any assurance of properties within the meaning of the Product Liability Act. The safety instructions in the product documentation must be observed. If the device is modified without the manufacturer's consent and the safety instructions are not followed, this declaration becomes invalid.

A copy of the original, product-specific EU Declaration of Conformity can be requested. For contact details, see page 2 of this manual.

14 Glossary

The following terms are commonly used in this manual or in video and KVM technology.

Term	Description
Cat X	Any Cat 5e (Cat 6, Cat 7) cable
Console	Keyboard, video and mouse
DDC	Display Data Channel (DDC) is a serial communication interface between monitor and source (computer, CPU). DDC enables data exchange via monitor cable and an automatic installation and configuration of a monitor driver by the operating system.
DisplayPort	A VESA standardized interface for an all-digital transmission of audio and video data. It is differentiated between the DisplayPort standards 1.1 and 1.2. The signals have LVDS level.
Dual-Head	A system with two video connections
HDMI	An interface for an all-digital transmission of audio and video data. It is differentiated between the HDMI standards 1.0 to 1.4a, also 2.0 to 2.0b or 2.1. The signals have TMDS level.
KVM	Keyboard, video and mouse
MTBF	Mean Time Between Failure (MTBF) is measured in power-on hours.
OSD	The On-Screen-Display is used to display information or to operate a device.
PCM	PCM (Pulse-Code-Modulation) is a pulse modulation method, also known as an uncompressed data format. The PCM method is used for converting analog audio into digital audio.
POH	Power-on hours corresponds to the average operating time
S/PDIF	Interface for electrical or optical transmission of digital stereo audio signals between different devices used in consumer electronics.
Single-Head	A system with one video connection
USB-HID	USB-HID devices (Human Interface Device) allow for data input. There is no need for a special driver during installation; "New USB-HID device found" is reported. Typical USB-HID devices include keyboards, mice, graphics tablets and touch screens. Storage, video and audio devices are not HID.