

heavy|mate® - C146 F Frame for 6 pin modules

Part No. C146 10P024 000 15

Frame for 6 pin modules

Series Heavy duty connectors heavy|mate® - C 146

Subseries Heavy duty connector heavy|mate® - C146 F



COMMON CHARACTERISTICS

Colour		black
Flammability		V-0

ELECTRICAL CHARACTERISTICS

Installation category	DIN EN 60664-1 / IEC 60664-1	III
Insulation group	DIN EN 60664-1 / IEC 60664-1	II
Insulation resistance	DIN EN 60512-3-1, Test 3a / IEC 60512-3-1, Test 3a	$\geq 10^{10}$
Contact resistance	DIN EN 60512-2-1, Test 2a / IEC 60512-2-1, Test 2a	< 5 m
Pollution degree	DIN EN 60664-1 / IEC 60664-1	3

heavy|mate® - C146 F Frame for 6 pin modules

Part No. C146 10P024 000 15

Frame for 6 pin modules

Series Heavy duty connectors heavy|mate® - C 146

Subseries Heavy duty connector heavy|mate® - C146 F

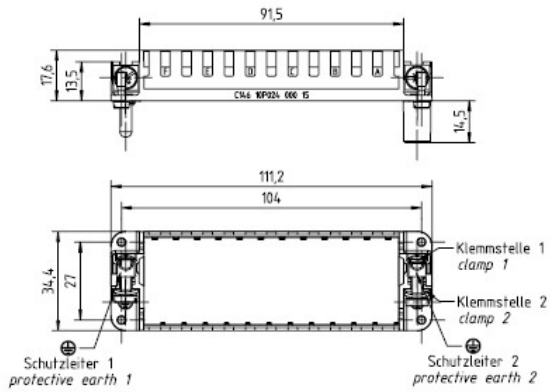

26.06.2013

Drawing Dimensions in mm (Inch)