

Turned contacts turned crimp male contact for wire gauge 20 - 16

Part No. VN01 016 0026 1C



Series Contacts

15.11.2012

Subseries Contact Turned contacts

COMMON CHARACTERISTICS

Wire gauge from		0,75
Wire gauge to		1,0
Wire gauge (AWG) from		20
Wire gauge (AWG) to		16
Packaging / supplied as		Single contact
No. of pieces		100
Sex of Contact		Pin
Type of contact		Turned crimp contact

CLIMATICAL CHARACTERISTICS

Upper temperature		+ 125 °C
Lower temperatur		- 40 °C

Turned contacts turned crimp male contact for wire gauge 20 - 16

Part No. VN01 016 0026 1C

Series Contacts

Subseries Contact Turned contacts



15.11.2012

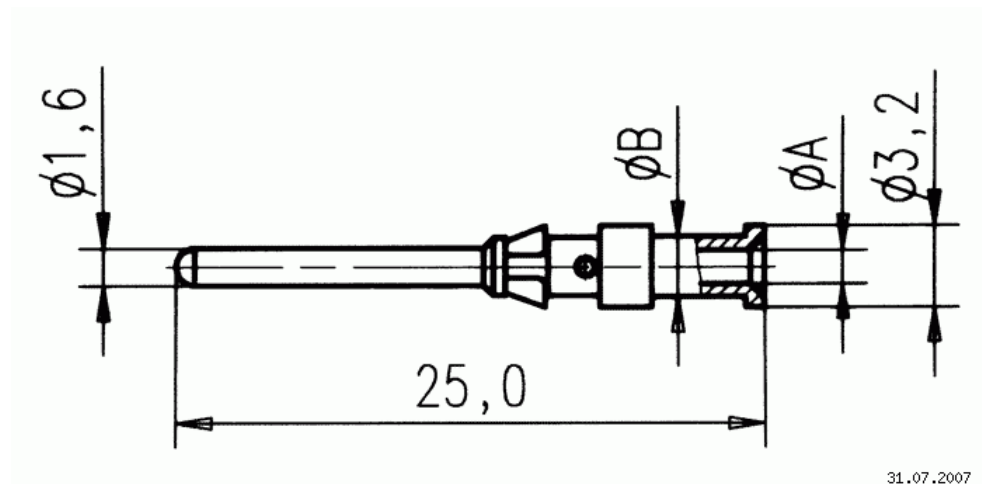

Drawing Dimensions in mm (Inch)

31.07.2007