

OMEGA™

4K / UHD

Wallplate HDBaseT Transmitter
for HDMI and USB-C with USB Hub



Version Information

Version	Release Date	Notes
1	Mar 2021	Initial Release

Welcome to Atlona!

Thank you for purchasing this Atlona product. We hope you enjoy it and will take an extra few moments to register your new purchase.

Registration only takes a few minutes and protects this product against theft or loss. In addition, you will receive notifications of product updates and firmware. Atlona product registration is voluntary and failure to register will not affect the product warranty.

To register your product, go to <http://www.atlona.com/registration>

Sales, Marketing, and Customer Support

Main Office

Atlona Incorporated
70 Daggett Drive
San Jose, CA 95134
United States

Office: +1.877.536.3976 (US Toll-free)
Office: +1.408.962.0515 (US/International)

Sales and Customer Service Hours
Monday - Friday: 6:00 a.m. - 4:30 p.m. (PST)

<http://www.atlona.com/>

International Headquarters

Atlona International AG
Ringstrasse 15a
8600 Dübendorf
Switzerland

Office: +41 43 508 4321

Sales and Customer Service Hours
Monday - Friday: 09:00 - 17:00 (UTC +1)

Operating Notes



IMPORTANT: Visit <http://www.atlona.com/product/AT-OME-SW21-TX-WPC> for the latest firmware updates and User Manual.

Atlona, Inc. (“Atlona”) Limited Product Warranty

Coverage

Atlona warrants its products will substantially perform to their published specifications and will be free from defects in materials and workmanship under normal use, conditions and service.

Under its Limited Product Warranty, Atlona, at its sole discretion, will either:

- repair or facilitate the repair of defective products within a reasonable period of time, restore products to their proper operating condition and return defective products free of any charge for necessary parts, labor and shipping.

OR

- replace and return, free of charge, any defective products with direct replacement or with similar products deemed by Atlona to perform substantially the same function as the original products.

OR

- refund the pro-rated value based on the remaining term of the warranty period, not to exceed MSRP, in cases where products are beyond repair and/or no direct or substantially similar replacement products exist.

Repair, replacement or refund of Atlona products is the purchaser’s exclusive remedy and Atlona liability does not extend to any other damages, incidental, consequential or otherwise.

This Limited Product Warranty extends to the original end-user purchaser of Atlona products and is non-transferrable to any subsequent purchaser(s) or owner(s) of these products.

Coverage Periods

Atlona Limited Product Warranty Period begins on the date of purchase by the end-purchaser. The date contained on the end-purchaser’s sales or delivery receipt is the proof purchase date.

Limited Product Warranty Terms – New Products

- 10 years from proof of purchase date for hardware/electronics products purchased on or after June 1, 2013.
- 3 years from proof of purchase date for hardware/electronics products purchased before June 1, 2013.
- Lifetime Limited Product Warranty for all cable products.

Limited Product Warranty Terms – Refurbished (B-Stock) Products

- 3 years from proof of purchase date for all Refurbished (B-Stock) hardware and electronic products purchased on or after June 1, 2013.

Remedy

Atlona recommends that end-purchasers contact their authorized Atlona dealer or reseller from whom they purchased their products. Atlona can also be contacted directly. Visit www.atlona.com for Atlona’s contact information and hours of operation. Atlona requires that a dated sales or delivery receipt from an authorized dealer, reseller or end-purchaser is provided before Atlona extends its warranty services. Additionally, a return merchandise authorization (RMA) and/or case number, is required to be obtained from Atlona in advance of returns.

Atlona requires that products returned are properly packed, preferably in the original carton, for shipping. Cartons not bearing a return authorization or case number will be refused. Atlona, at its sole discretion, reserves the right to reject any products received without advanced authorization. Authorizations can be requested by calling 1-877-536-3976 (US toll free) or 1-408- 962-0515 (US/international) or via Atlona’s website at www.atlona.com.

Exclusions

This Limited Product Warranty excludes:

- Damage, deterioration or malfunction caused by any alteration, modification, improper use, neglect, improper packaging or shipping (such claims must be presented to the carrier), lightning, power surges, or other acts of nature.

Atlona, Inc. (“Atlona”) Limited Product Warranty

- Damage, deterioration or malfunction resulting from the installation or removal of this product from any installation, any unauthorized tampering with this product, any repairs attempted by anyone unauthorized by Atlona to make such repairs, or any other cause which does not relate directly to a defect in materials and/or workmanship of this product.
- Equipment enclosures, cables, power supplies, batteries, LCD displays, and any accessories used in conjunction with the product(s).
- Products purchased from unauthorized distributors, dealers, resellers, auction websites and similar unauthorized channels of distribution.

Disclaimers

This Limited Product Warranty does not imply that the electronic components contained within Atlona’s products will not become obsolete nor does it imply Atlona products or their electronic components will remain compatible with any other current product, technology or any future products or technologies in which Atlona’s products may be used in conjunction with. Atlona, at its sole discretion, reserves the right not to extend its warranty offering in instances arising outside its normal course of business including, but not limited to, damage inflicted to its products from acts of god.

Limitation on Liability

The maximum liability of Atlona under this limited product warranty shall not exceed the original Atlona MSRP for its products. To the maximum extent permitted by law, Atlona is not responsible for the direct, special, incidental or consequential damages resulting from any breach of warranty or condition, or under any other legal theory. Some countries, districts or states do not allow the exclusion or limitation of relief, special, incidental, consequential or indirect damages, or the limitation of liability to specified amounts, so the above limitations or exclusions may not apply to you.

Exclusive Remedy

To the maximum extent permitted by law, this limited product warranty and the remedies set forth above are exclusive and in lieu of all other warranties, remedies and conditions, whether oral or written, express or implied. To the maximum extent permitted by law, Atlona specifically disclaims all implied warranties, including, without limitation, warranties of merchantability and fitness for a particular purpose. If Atlona cannot lawfully disclaim or exclude implied warranties under applicable law, then all implied warranties covering its products including warranties of merchantability and fitness for a particular purpose, shall provide to its products under applicable law. If any product to which this limited warranty applies is a “Consumer Product” under the Magnuson-Moss Warranty Act (15 U.S.C.A. §2301, ET SEQ.) or other applicable law, the foregoing disclaimer of implied warranties shall not apply, and all implied warranties on its products, including warranties of merchantability and fitness for the particular purpose, shall apply as provided under applicable law.

Other Conditions

Atlona’s Limited Product Warranty offering gives legal rights, and other rights may apply and vary from country to country or state to state. This limited warranty is void if (i) the label bearing the serial number of products have been removed or defaced, (ii) products are not purchased from an authorized Atlona dealer or reseller. A comprehensive list of Atlona’s authorized distributors, dealers and resellers can be found at www.atlona.com.

Important Safety Information



CAUTION: TO REDUCE THE RISK OF ELECTRIC SHOCK DO NOT OPEN ENCLOSURE OR EXPOSE TO RAIN OR MOISTURE. NO USER-SERVICEABLE PARTS INSIDE REFER SERVICING TO QUALIFIED SERVICE PERSONNEL.



The exclamation point within an equilateral triangle is intended to alert the user to the presence of important operating and maintenance instructions in the literature accompanying the product.



The information bubble is intended to alert the user to helpful or optional operational instructions in the literature accompanying the product.

1. Read these instructions.
2. Keep these instructions.
3. Heed all warnings.
4. Follow all instructions.
5. Do not use this product near water.
6. Clean only with a dry cloth.
7. Do not block any ventilation openings. Install in accordance with the manufacturer's instructions.
8. Do not install or place this product near any heat sources such as radiators, heat registers, stoves, or other apparatus (including amplifiers) that produce heat.
9. Do not defeat the safety purpose of a polarized or grounding-type plug. A polarized plug has two blades with one wider than the other. A grounding type plug has two blades and a third grounding prong. The wide blade or the third prong are provided for your safety. If the provided plug does not fit into your outlet, consult an electrician for replacement of the obsolete outlet.
10. Protect the power cord from being walked on or pinched particularly at plugs, convenience receptacles, and the point where they exit from the product.
11. Only use attachments/accessories specified by Atlona.
12. To reduce the risk of electric shock and/or damage to this product, never handle or touch this unit or power cord if your hands are wet or damp. Do not expose this product to rain or moisture.
13. Unplug this product during lightning storms or when unused for long periods of time.
14. Refer all servicing to qualified service personnel. Servicing is required when the product has been damaged in any way, such as power-supply cord or plug is damaged, liquid has been spilled or objects have fallen into the product, the product has been exposed to rain or moisture, does not operate normally, or has been dropped.



FCC Statement

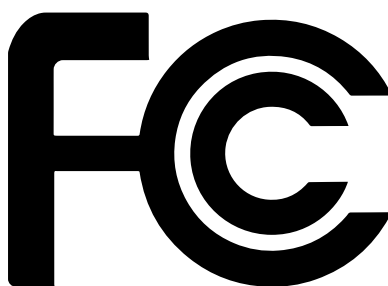

FCC Compliance and Advisory Statement: This hardware device complies with Part 15 of the FCC rules. Operation is subject to the following two conditions: 1) this device may not cause harmful interference, and 2) this device must accept any interference received including interference that may cause undesired operation. This equipment has been tested and found to comply with the limits for a Class A digital device, pursuant to Part 15 of the FCC Rules. These limits are designed to provide reasonable protection against harmful interference in a commercial installation.

This equipment generates, uses, and can radiate radio frequency energy and, if not installed or used in accordance with the instructions, may cause harmful interference to radio communications. However there is no guarantee that interference will not occur in a particular installation. If this equipment does cause harmful interference to radio or television reception, which can be determined by turning the equipment off and on, the user is encouraged to try to correct the interference by one or more of the following measures: 1) reorient or relocate the receiving antenna; 2) increase the separation between the equipment and the receiver; 3) connect the equipment to an outlet on a circuit different from that to which the receiver is connected; 4) consult the dealer or an experienced radio/TV technician for help. Any changes or modifications not expressly approved by the party responsible for compliance could void the user's authority to operate the equipment. Where shielded interface cables have been provided with the product or specified additional components or accessories elsewhere defined to be used with the installation of the product, they must be used in order to ensure compliance with FCC regulations.

Table of Contents

Introduction	8
Features	8
Package Contents	8
Panel Description	9
Installation	10
Connection Instructions	10
Connection Diagram	11
Faceplate Removal and Assembly	12
Device Operation	13
LED Indicators	13
Logging in to the Web Server	14
Login Registration	14
Logging in after registration	15
Selecting the Input	16
Auto-Switching	17
HDCP Content	18
Audio Muting	19
EDID Management	20
Using the Downstream EDID	20
EDID Presets	21
Storing EDID Data	22
USB Modes	24
Follow USB	24
Manual	25
Follow Video	26
User Management	27
Changing the Administrator Password	27
Adding Users	28
Editing / Deleting Users	29
System Configuration	30
Setting the IP Mode	30
Changing the Telnet Port	31
Telnet Login Mode	31
Adjusting Telnet Timeout	32
Setting the Host Name	33
Resetting to Factory-Default Settings	34
HDBaseT Testing	35
Configuration and Management Interfaces	36
Web Server	36
Info Page	36
A/V Settings Page	38
Display Page	39
RS-232 Page	42
EDID Page	43
USB Page	44
Config Page	45
System Page	46
HDBT Page	48
Updating the Firmware	49
Using the Web Server	49
Using USB	50
Specifications	52

Introduction

The Atlona **AT-OME-SW21-TX-WPC** is a 2×1 switcher and HDBaseT transmitter with HDMI and USB-C inputs. It sends video up to 4K/60 4:2:0, plus embedded audio, control, and USB over distances up to 330 feet (100 meters). The OME-SW21-TX-WPC features a US one-gang, wallplate form factor, and includes interchangeable black and white wallplates and faceplates. Part of the Omega™ Series of integration products for modern AV communications and collaboration, the OME-SW21-TX-WPC is HDCP 2.2 compliant. The USB-C input is ideal for AV interfacing with newer Mac®, Chromebook™, and Windows® PCs, as well as smartphones and tablets. With a matching HDBaseT receiver, the integrated USB extension addresses the challenge of connecting between USB devices at remote locations, and is ideal for software video conferencing and touch or interactive displays. The OME-SW21-TX-WPC includes USB 2.0 and USB-C PC host interfaces, plus a USB 2.0 interface for a peripheral device such as a speakerphone, microphone, or keyboard and mouse. This transmitter is ideal for use with Omega Series receivers as well as switchers with HDBaseT inputs.

Features

- US one-gang enclosure for wallplate openings – interchangeable black or white trim kits
- 2×1 HDBaseT switcher with HDMI and USB-C inputs
- Video, audio, power, and data over category cable utilizing HDBaseT technology
- USB 2.0 interfacing and extension up to 330 feet (100 meters)
- 4K/UHD capability @ 60 Hz with 4:2:0 chroma subsampling
- Remote powering over HDBaseT
- Automatic display control
- Automatic input selection using hot plug detect and video detection technology

Package Contents

- 1 x AT-OME-SW21-TX-WPC
- 1 x White faceplate
- 1 x White wallplate
- 1 x Black faceplate
- 1 x Black wallplate
- 4 x Mounting screws
- 1 x USB-C to USB-C cable, 2 meters
- 1 x Installation Guide

Panel Description

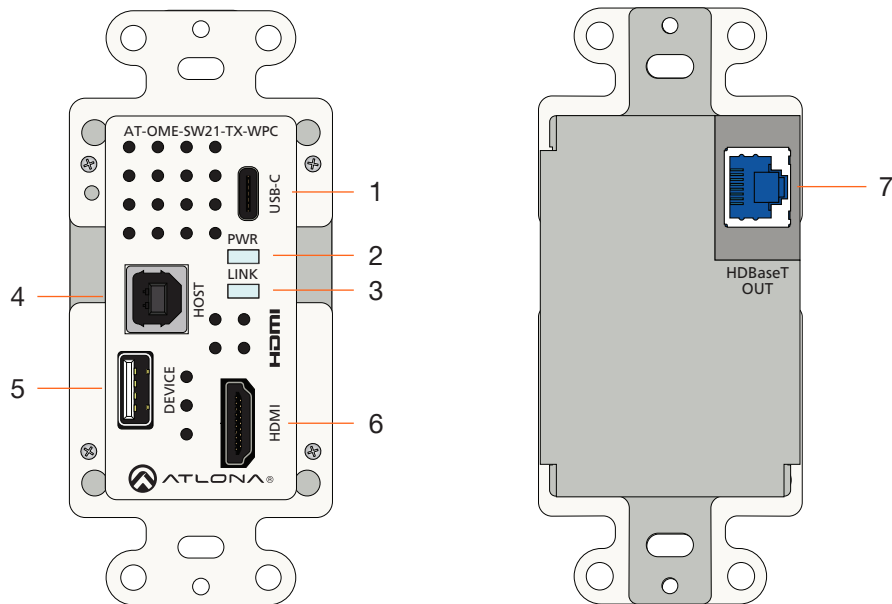

1 USB-C

Connect a USB-C cable from this port to the USB-C port of a source device.

2 PWR

This LED indicator glows solid green when the unit is powered. Refer to [LED Indicators \(page 13\)](#) for more information.

3 LINK

This LED indicator glows solid amber to indicate that the HDBaseT signal integrity is good. Refer to [LED Indicators \(page 13\)](#) for more information.

4 HOST

Connect a USB cable from this port to the host computer.

5 DEVICE

Connect a USB device, such as a speakerphone, to this port. This port provides 5 W of power.

6 HDMI

Connect an HDMI cable from this port to a UHD/HD source.

7 HDBaseT OUT

Connect a category cable from this port to the **HDBaseT IN** port of the AT-OME-EX-RX or other PoE-compatible receiver.

Installation

Connection Instructions

Determine the proper faceplate to be used for installation. The AT-OME-SW21-TX-WPC is shipped with the white faceplate, attached. If using the black faceplate, then refer to [Faceplate Removal and Assembly \(page 12\)](#) for information on changing the faceplate.

1. Connect an category cable (CAT-5e or better), from the **HDBaseT OUT** port, on the rear of the unit, to an HDBaseT receiver. This unit is powered over category cable, from a compatible HDBaseT receiver. Category cables should use EIA/TIA-568B termination. IP network is also data is carried over the **HDBaseT OUT** port.
2. Complete the installation of the AT-OME-SW21-TX-WPC into the electrical box or mudring.
3. Connect a USB-C cable from the source to the **USB-C** port.

Refer to the tables below for recommended cabling when using Altona products with HDBaseT technology. The green bars indicate the signal quality when using each type of cable. Higher-quality signals are represented by more bars. *These table are for guidance, only. Performance may vary, based on environmental factors.*

Core	Shielding	CAT5e	CAT6	CAT6a	CAT7
Solid	UTP (unshielded)	■	■■■	■■■■■	N/A
	STP (sheilded)	■■	■■■■	■■■■■	■■■■■

Cable	Max. Distance @ 4K	Max. Distance @ 1080p
CAT5e	295 feet (90 meters)	330 feet (100 meters)
CAT6 / 6a / CAT7	330 feet (100 meters)	330 feet (100 meters)



IMPORTANT: Stranded or patch cable is not recommended due to performance issues. Sheilded cables are strongly recommended to minimize signal noise and interference.

4. Connect an HDMI cable from a UHD/HD source to the **HDMI** port.
5. Connect a USB cable from the host computer to the **HOST** port.
6. Connect a USB device, such as a speakerphone to the **DEVICE** port. This port provides 5 W of power.

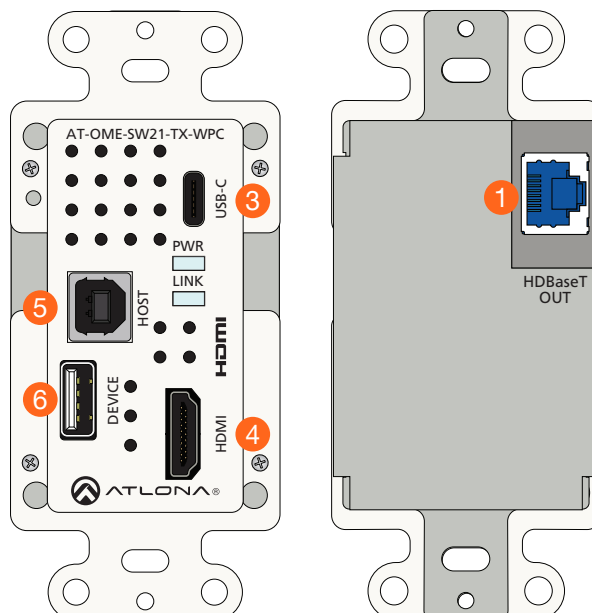

Connection Diagram

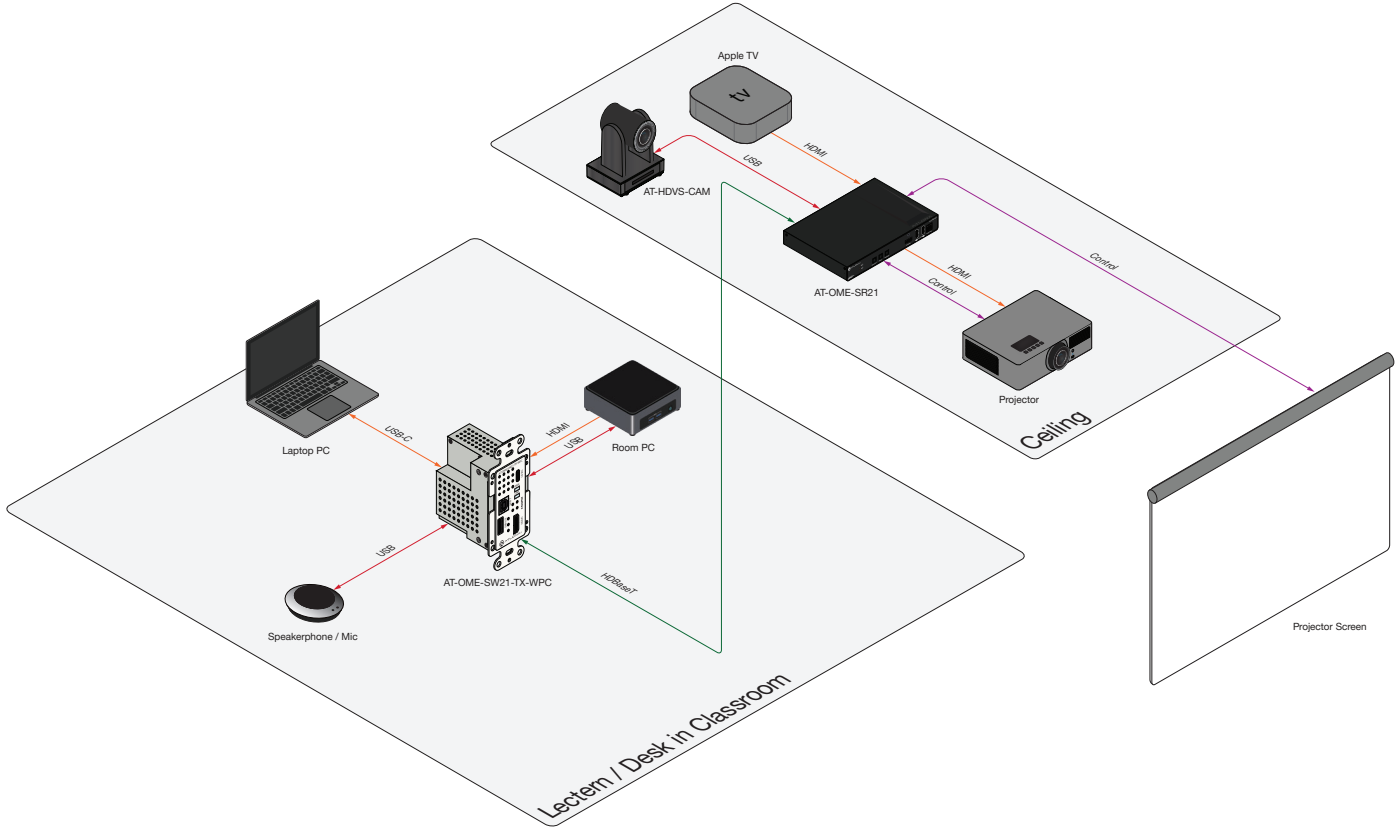

Faceplate Removal and Assembly

The AT-OME-SW21-TX-WPC includes an optional black faceplate. The AT-OME-SW21-TX-WPC is shipped with the white faceplate, attached. Removal of the faceplate requires that the AT-OME-SW21-TX-WPC be disassembled from the electrical box or mud ring. A small Phillips-head screwdriver is required to remove the faceplate.

1. Unscrew the four Phillips-head screws from the sides of the faceplate, as shown.

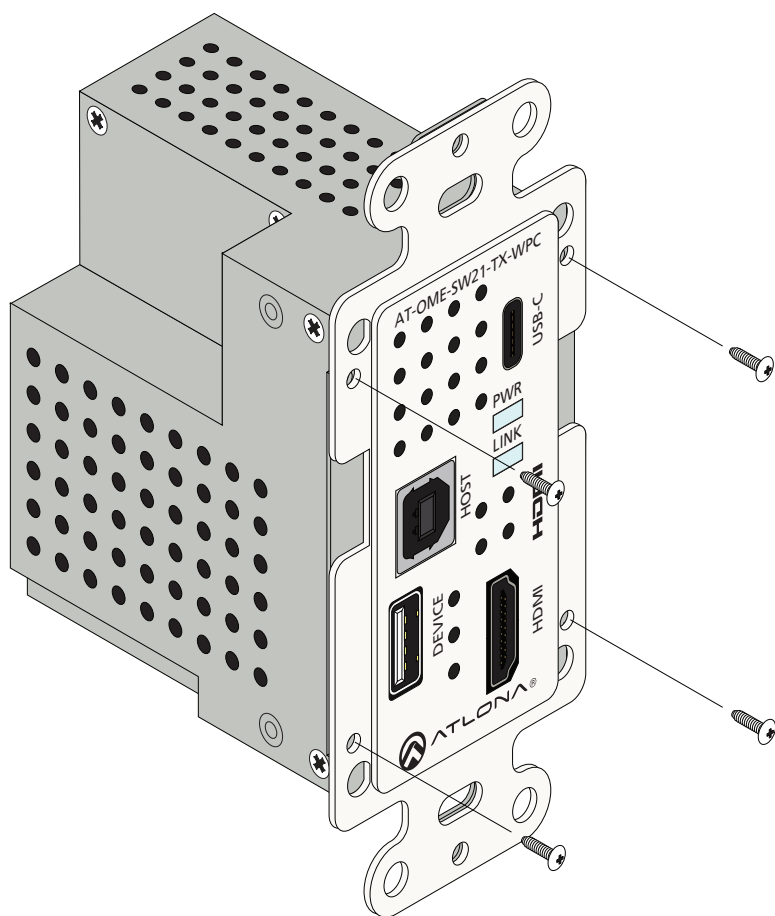





2. Gently remove the faceplate by pulling it toward you.
3. Attach the new faceplate, then secure it using the four Phillips-head screws. Do not over-tighten or apply high-torque devices to the screws. Doing so may damage the faceplate and/or the screws.
4. Install the AT-OME-SW21-TX-WPC into the electrical box or mud ring.
5. Reattach the wallplate.

Device Operation

LED Indicators

The LED indicators on both the front of the unit provide basic information on the current status of the AT-OME-SW21-TX-WPC.

LED		Description
POWER	Solid green 	<ul style="list-style-type: none"> Unit is powered and is in normal operating mode.
	Off 	<ul style="list-style-type: none"> Unit is not powered.
LINK	Solid Amber 	<ul style="list-style-type: none"> The HDBaseT link between the AT-OME-SW21-TX-WPC and the compatible PoE receiver is good. <p> NOTE: If the LINK LED is ON, but the PWR LED is off, then this indicates that display control has been triggered and the system is currently in an OFF state.</p>
	Off 	<ul style="list-style-type: none"> The AT-OME-SW-TX-WPC is not connected to a compatible PoE receiver.

Logging in to the Web Server

Operation of the AT-OME-SW21-TX-WPC is handled through the built-in web server. In order to access the web server, the IP address of the unit must be known. The AT-OME-SW21-TX-WPC is shipped with DHCP enabled. Once connected to a network, the DHCP server (if available), will automatically assign an IP address to the unit. Using an IP scanner, along with the MAC address on the rear of the unit, can be used to identify the unit on the network.



NOTE: IP communications are carried over the **HDBaseT OUT** port. Therefore, in order to access the built-in web server, the AT-OME-SW21-TX-WPC must be connected to a receiver unit, such as the AT-OME-EX-RX. The receiver unit must be connected to the network using its **LAN** port.

Login Registration

1. Launch the desired web browser and enter the IP address of the AT-OME-SW21-TX-WPC in the address bar.
2. The AT-OME-SW21-TX-WPC **Register** page will be displayed.

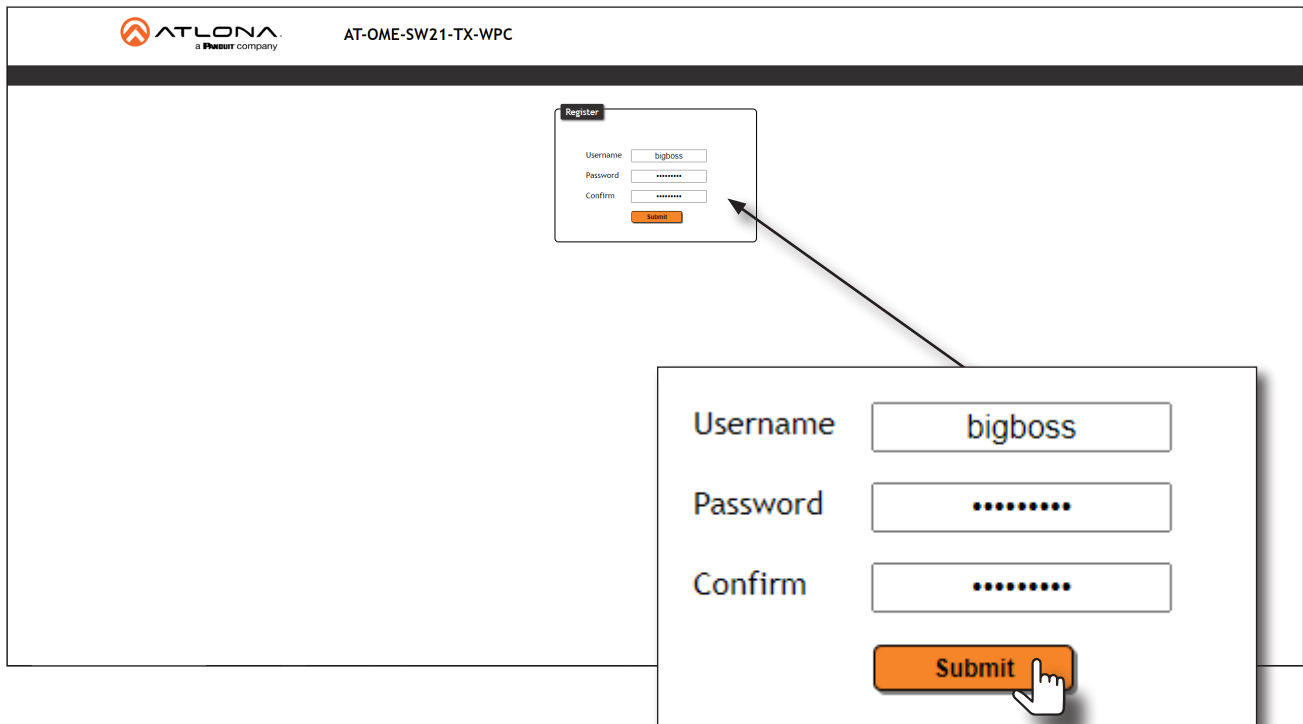

3. Enter the desired username in the **Username** field. Note that during the registration process, the **Username** field cannot be set to `root`.
4. Enter the desired password in the **Password** field.



IMPORTANT: The password must contain a minimum of 8 characters, including: 1 uppercase character, 1 lowercase character, and 1 number. Note that the **Password** and **Confirm** fields will be masked when entering the password.

5. Verify the password by entering it in the **Confirm** field.
6. Click the **Submit** button. The **Info** screen will be displayed. Refer to [Info Page \(page 36\)](#) for more information.

Logging in after registration

1. Launch the desired web browser and enter the IP address of the AT-OME-SW21-TX-WPC in the address bar.
2. Enter the correct username and password in the respective fields.
3. Click the **Submit** button.

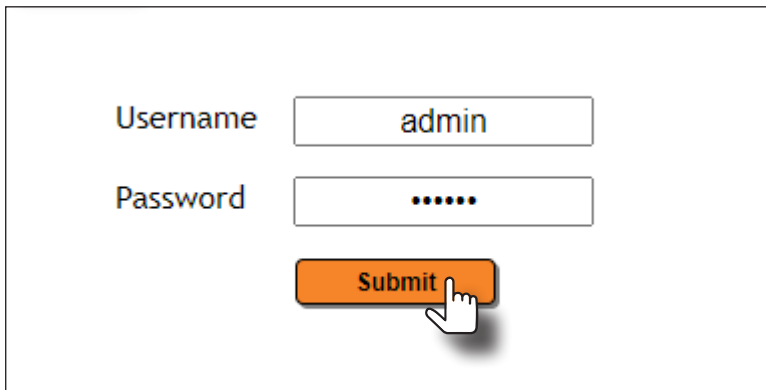

The image shows a login form with the following elements:

- Username:** A text input field containing the text "admin".
- Password:** A text input field containing six dots "....." to mask the password.
- Submit:** An orange button with the text "Submit" and a white mouse cursor icon pointing to it.

4. The **Info** page will be displayed and the login process is complete. Refer to [Info Page \(page 36\)](#) for more information.

Selecting the Input

1. Login to the web server. Refer to [Logging in to the Web Server](#) (page 14) for more information.
2. Click **A/V Settings** in the menu bar.
3. Under the **Video** window group, click the **Input Selection** drop-down list and select the desired input.

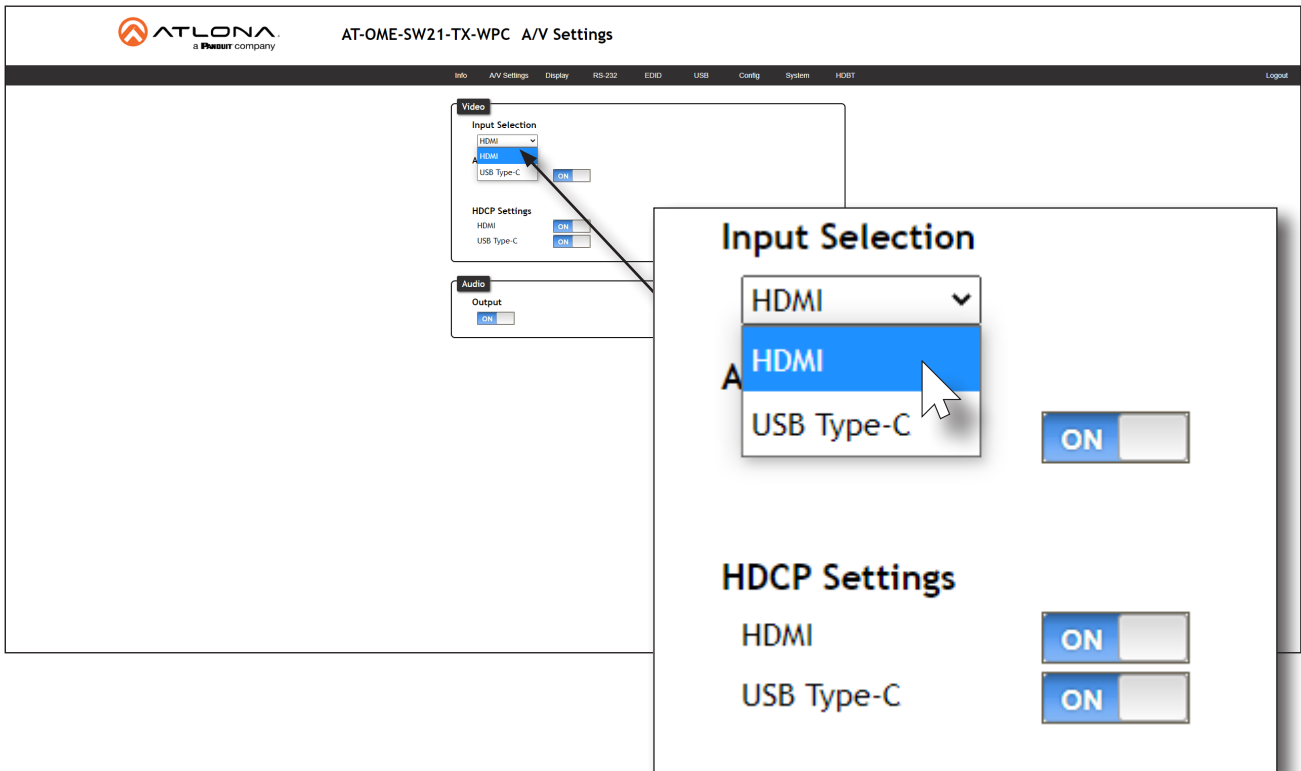

Auto-Switching

The AT-OME-SW21-TX-WPC provides auto-switching capability, which is enabled by default. This feature will automatically switch the input to the most recently-connected source. If a source is disconnected, then the input will automatically be switched to the previously-connected source.

1. Login to the web server. Refer to [Logging in to the Web Server \(page 14\)](#) for more information.
2. Click **A/V Settings** in the menu bar.
3. Under the **Video** window group, the **Auto Switch** toggle switch will be set to the ON position, indicating that auto-switching is enabled.
4. Click the **Auto Switch** toggle switch to the OFF position to disable auto-switching. Note that when disabled, if the previously active input is no longer available, no switching will occur.



NOTE: The AT-OME-SW21-TX-WPC retains the currently selected input, even after the unit is powered-off then powered-on. The system should re-evaluate the auto switching logic after power on, and then select an input.

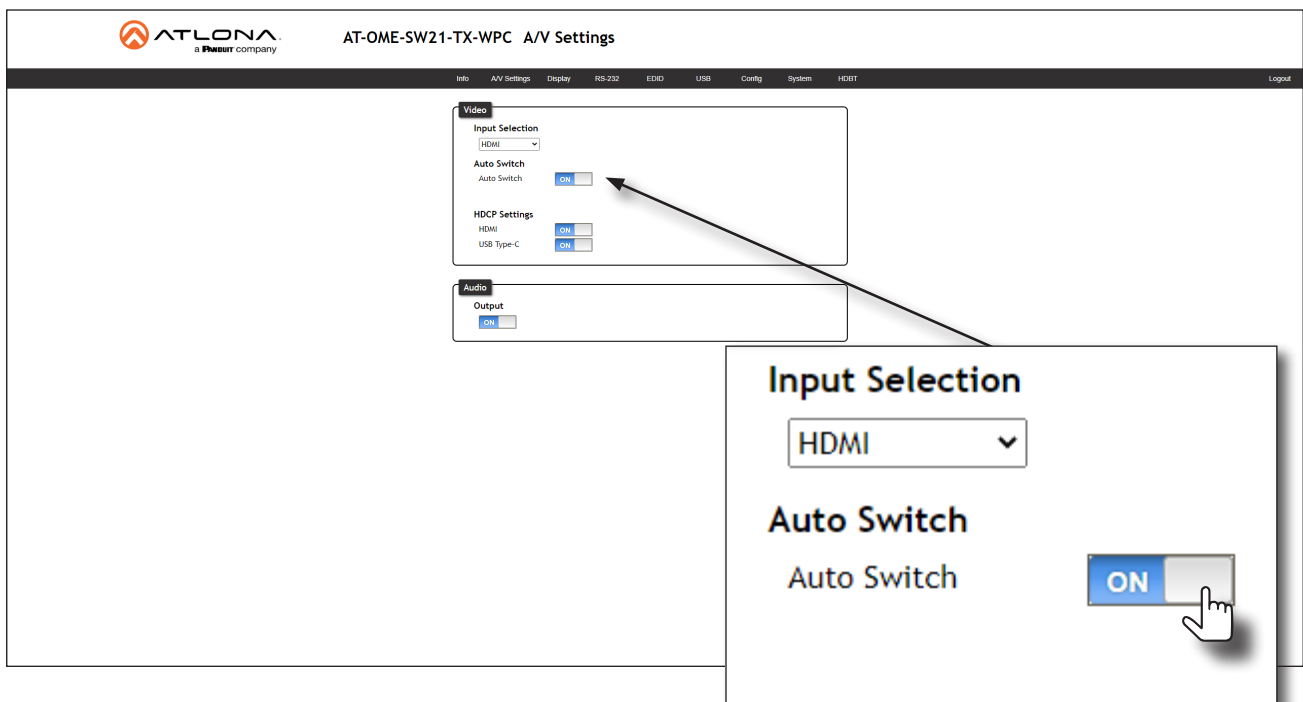

HDCP Content

Normally, if a source is transmitting HDCP content to a display that is not HDCP-compatible, then the resulting image on the display can be “snow”, image flickering, or no picture. For example, in the illustration below, a Blu-ray player HDCP source is connected to the AT-OME-SW21-TX-WPC. A non-compliant display is connected to an AT-OME-EX-RX, which is connected to the AT-OME-SW21-TX-WPC using HDBaseT.



IMPORTANT: Not all source devices are capable of transmitting non-HDCP content. For example, Sony PlayStation® gaming consoles and Apple® computers will always default to HDCP. However, if they detect a non-HDCP source, non-HDCP content will be transmitted.

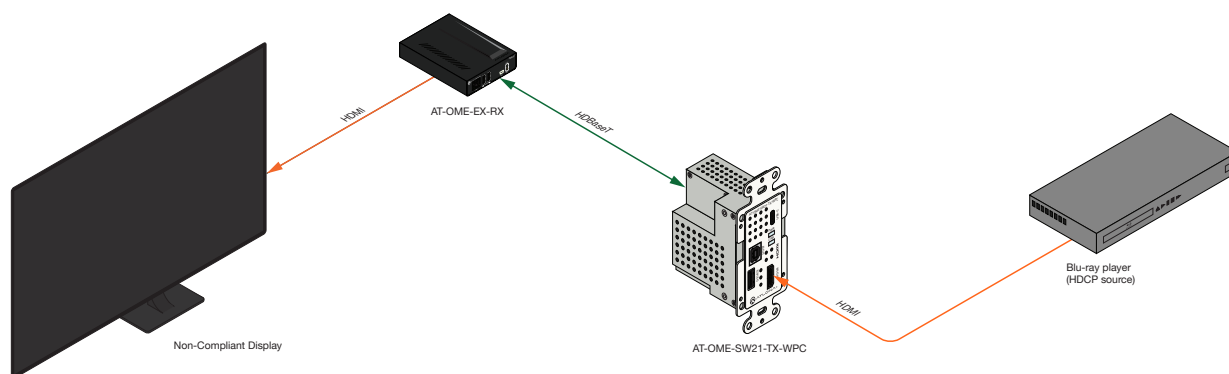

By default, a laptop may transmit HDCP content. However, when connected to a display that does not support HDCP, the laptop must be instructed to send non-HDCP content, in order for the content to be displayed.

1. Login to the web server. Refer to [Logging in to the Web Server \(page 14\)](#) for more information.
2. Click **A/V Settings** in the menu bar.
3. Under the **Video** window group, click the toggle switch next to the desired input. In this example, clicking the **HDMI** toggle switch to the **OFF** position will instruct the source connected to the HDMI port to send non-HDCP content, if possible. If the display is unable to receive HDCP content, then a green splash screen will appear on the connected display, with the following message:

HDCP INCOMPATIBILITY

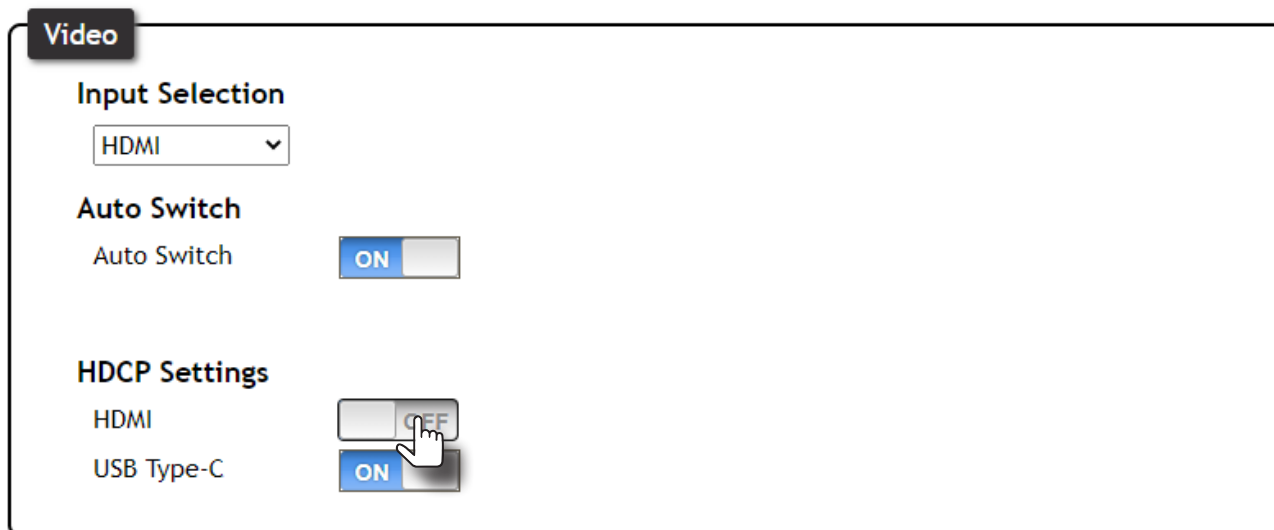

Audio Muting

The AT-OME-SW21-TX-WCP provides control over audio muting on the output.

1. Login to the web server. Refer to [Logging in to the Web Server \(page 14\)](#) for more information.
2. Click **A/V Settings** in the menu bar.
3. Under the **Audio** window group, click the Output toggle switch to either the **ON** or **OFF** position. For example, to mute the audio output set this toggle switch to the **OFF** position. To re-enable the audio on the output, set the toggle switch to the **ON** position.



EDID Management

Before a source can send picture and sound to a display device, the source reads the EDID (Extended Display Identification Data) stored in the display. The EDID contains information about what type of video and audio formats are supported by the display. The AT-OME-SW21-TX-WPC can use either the downstream EDID (from the display/sink) or use a built-in EDID preset. Custom EDID data can also be stored in a user-defined preset. This section will cover each of the following topics:

- EDID Presets
- Using the Downstream EDID
- Storing EDID Data

Using the Downstream EDID

By default, the AT-OME-SW21-TX-WPC will read the EDID from the display device. The term “downstream” is used to describe any device that receives a signal from another device. For example, if a Blu-ray player is connected to a display, the display is said to be “downstream” of the Blu-ray player.

1. Login to the web server. Refer to [Logging in to the Web Server \(page 14\)](#) for more information.
2. Click **EDID** in the menu bar.
3. Locate the **EDID Settings** section.
4. Click the drop-down list next to the desired input and select **Connected Display**. For example, to have the **HDMI** port use the EDID of the connected display, click the **HDMI** drop-down list and select **Connected Display**.

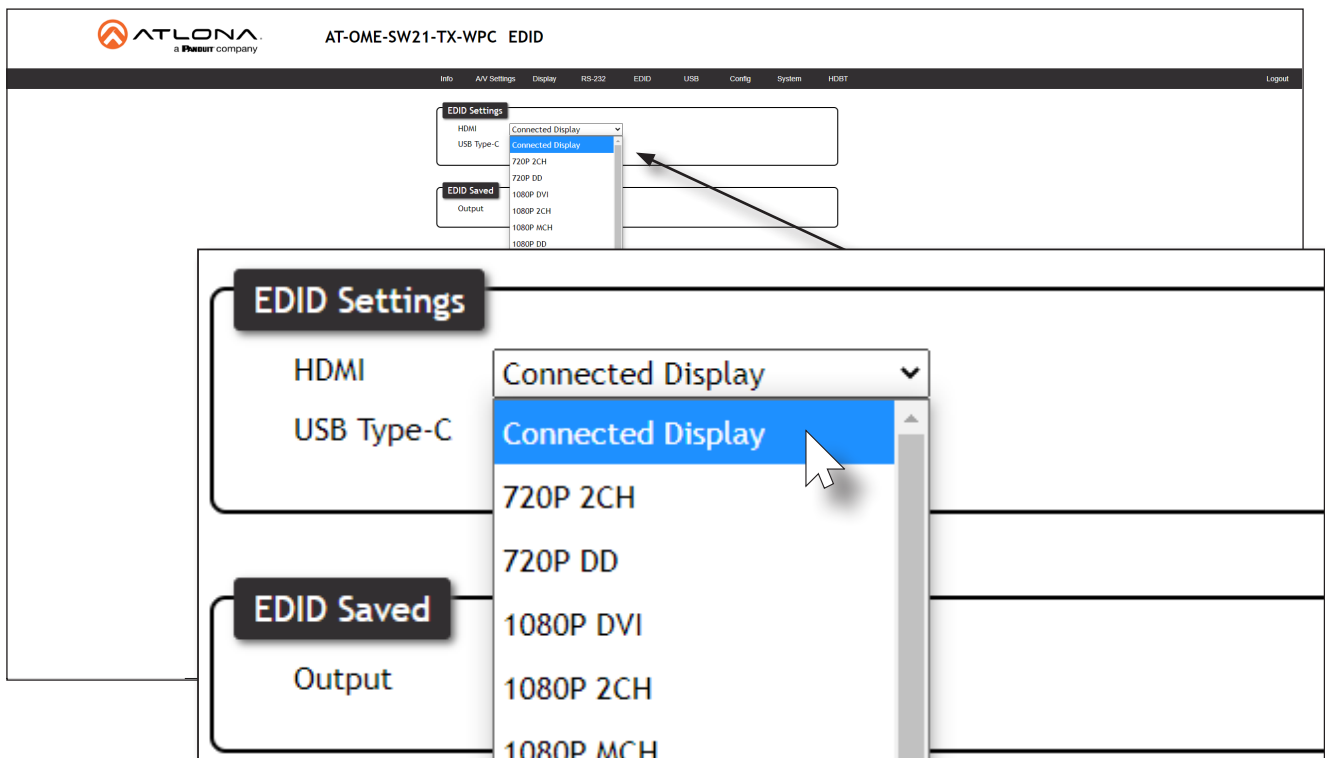

EDID Presets

The AT-OME-SW21-TX-WPC provides the option of selecting a preset EDID. The following presets are available. For information on storing custom EDID data, refer to [Storing EDID Data \(page 22\)](#).



IMPORTANT: If problems are encountered when using an EDID preset, try using the default setting of **Connected Display**.

1. Login to the web server. Refer to [Logging in to the Web Server \(page 14\)](#) for more information.
2. Click **EDID** in the menu bar.
3. Locate the **EDID Settings** section.
4. Click the drop-down list, next to the port that is connected to the display device, and select the desired EDID preset. For example, to have the **HDMI** port use a specific EDID, click the **HDMI** drop-down list.

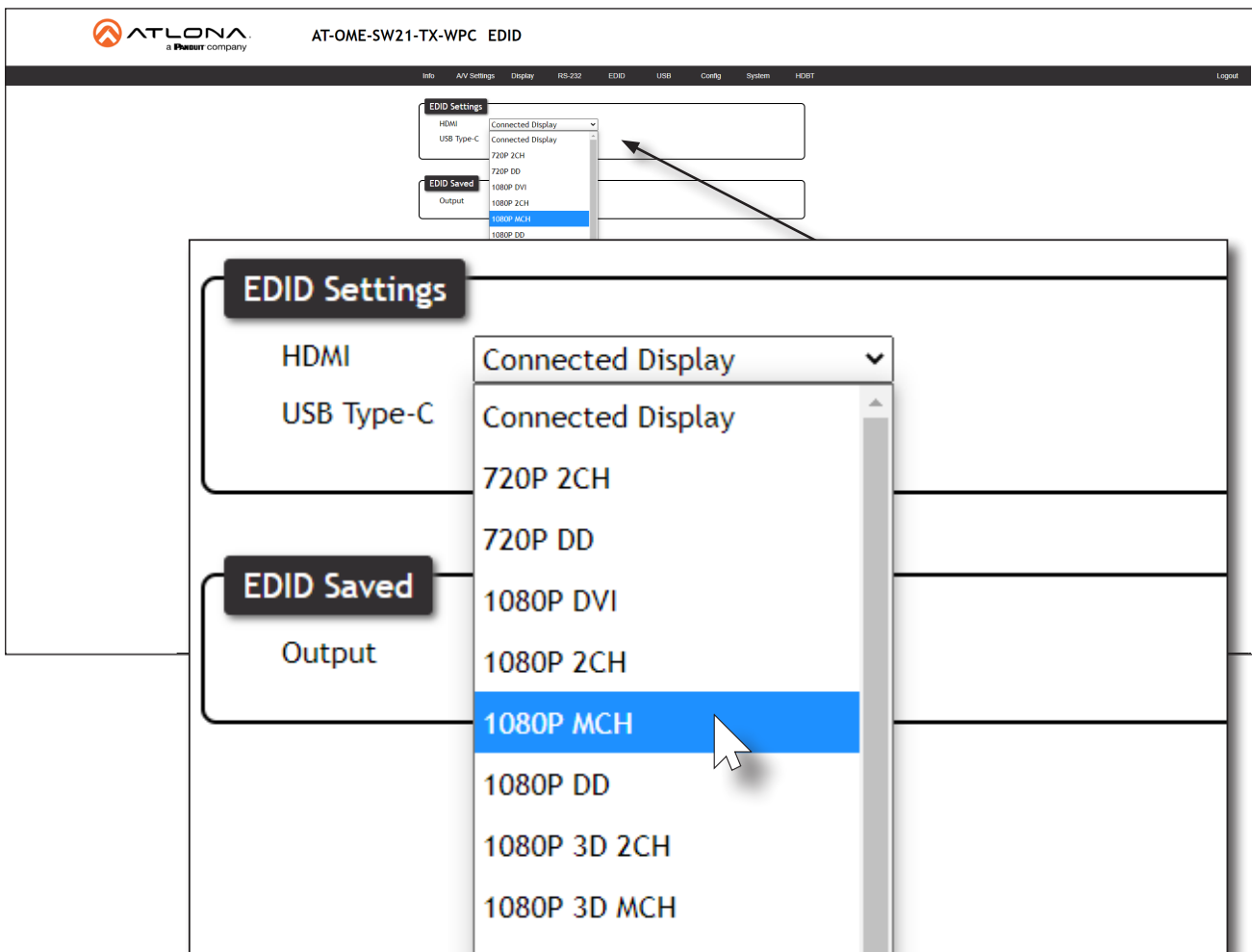

Storing EDID Data

The AT-OME-SW21-TX-WPC provide a two memory locations, which can be used to store EDID data. Any downstream EDID can be captured and stored in these locations. The memory location is non-volatile and captured EDID data is retained after power is disconnected from the unit.

1. Make sure the system is powered and wired, as shown in the illustration below.
2. Connect an HDMI cable from the **HDMI OUT** port on the receiver endpoint of the AT-OME-SW21-TX-WPC, containing the EDID to be stored. In this example, the AT-OME-EX-RX is used as a receiver unit.
3. Login to the web server of the AT-OME-SW21-TX-WPC. Refer to [Logging in to the Web Server \(page 14\)](#) for more information.
4. Click **EDID** in the menu bar.

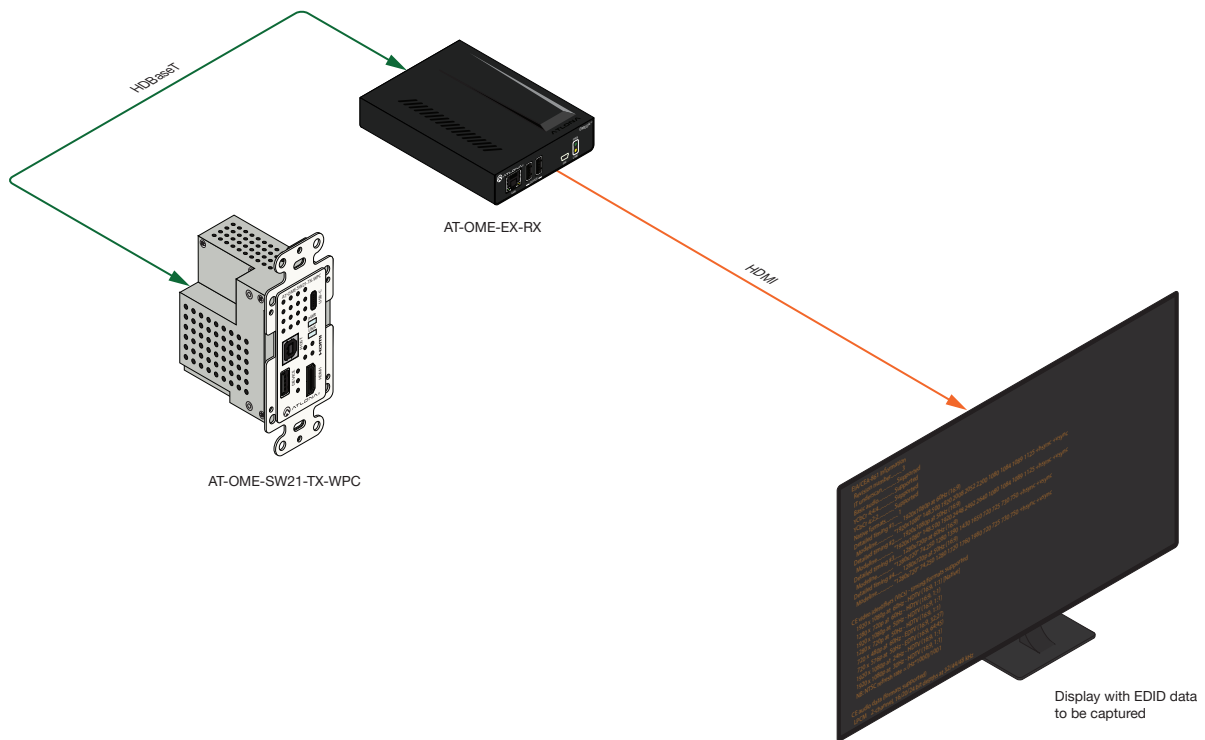

5. Locate the **EDID Saved** section.

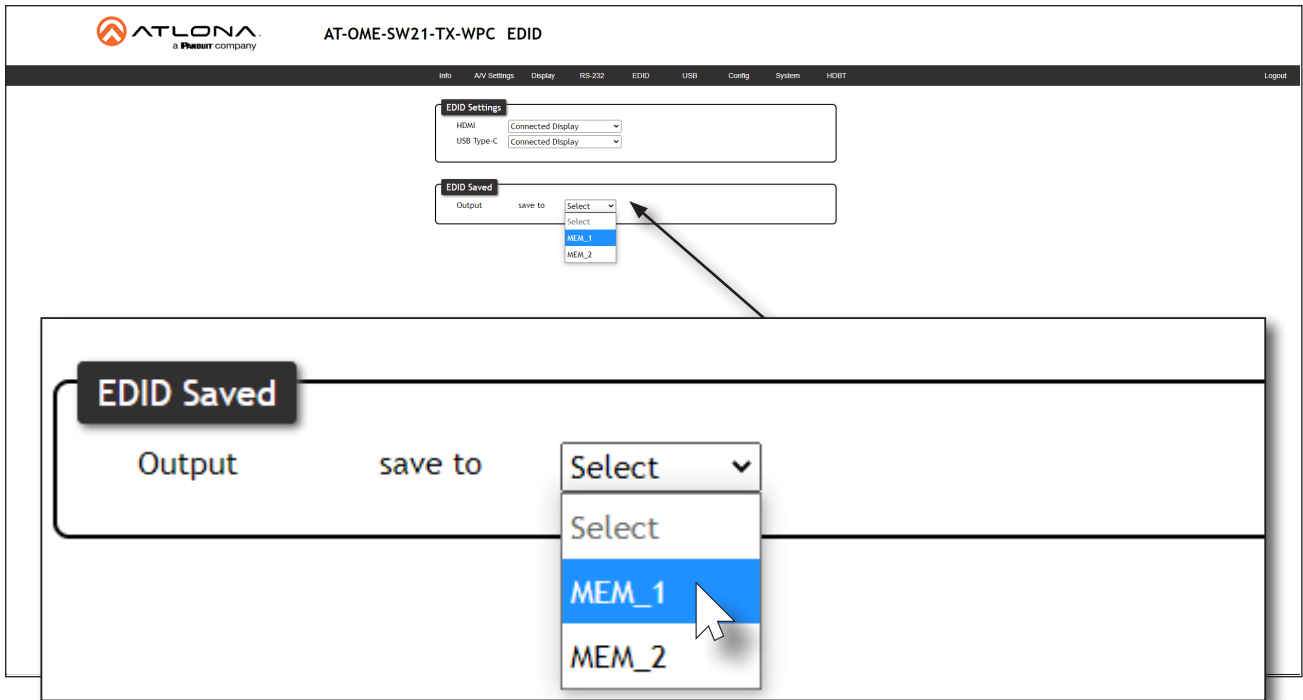

6. Click the **Output save to** drop-down list and select the desired memory location where the EDID will be stored.
7. Once selected, the downstream EDID will be saved to the selected memory location.
8. Click any of the input drop-down list boxes, under the **EDID Settings** window group. Note that the stored EDID appears as an available EDID preset for each available input on the AT-OME-SW21-TX-WPC.

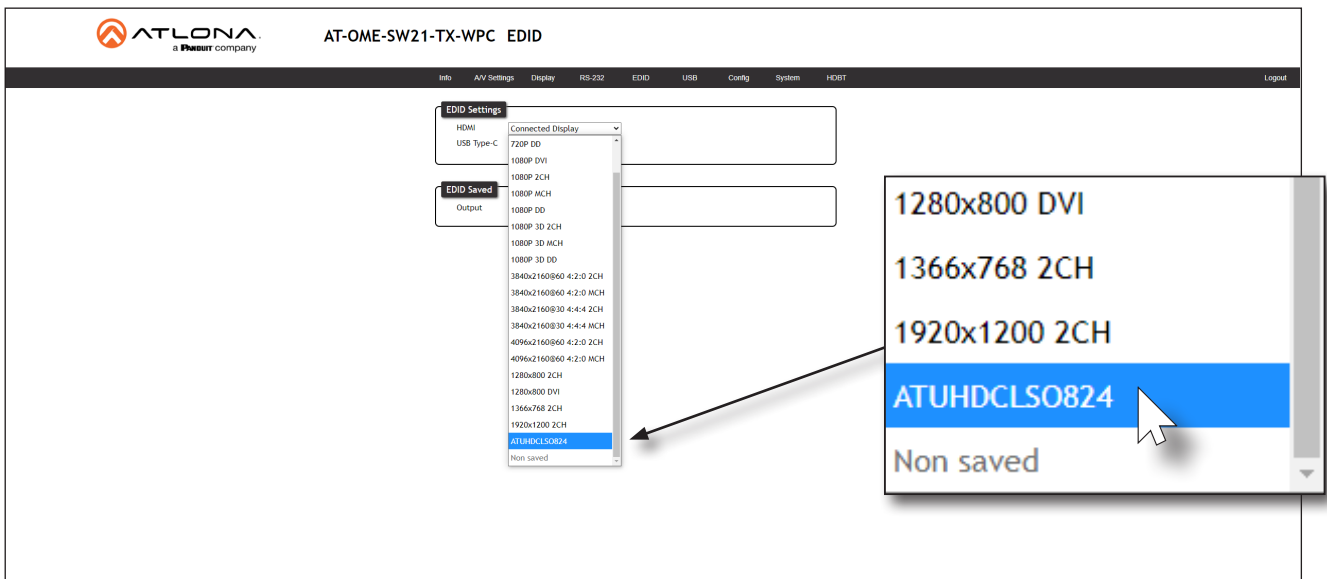

NOTE: Once an EDID is written to a memory location, it can be overwritten with a different EDID, when desired. To overwrite an EDID with a different EDID, repeat steps 5 through 7, above.

USB Modes

The AT-OME-SW21-TX-WPC provides three USB modes: **Manual**, **Follow USB**, and **Follow Video**. Each mode provides different method of selecting the USB host ports. Note that the **USB-C** port also serves as a host port.

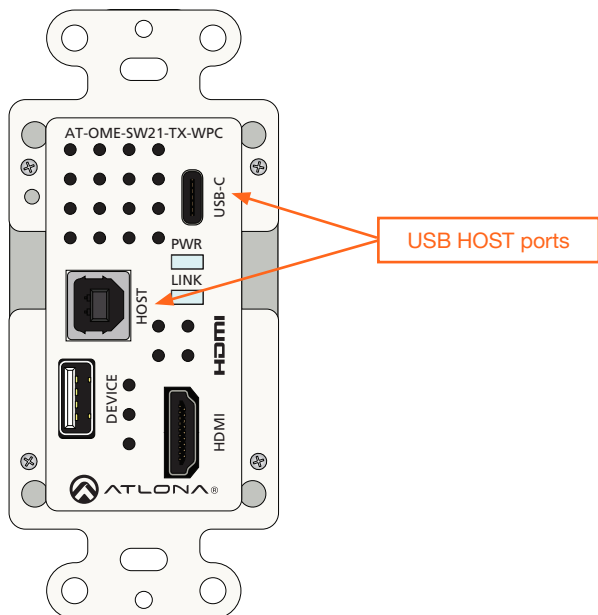

Follow USB

This is the default mode. In this mode, the AT-OME-SW21-TX-WPC will detect which USB ports are connected to a host device. If all USB host ports are connected to host devices, then the AT-OME-SW21-TX-WPC will set the last-connected USB host device as the “active” USB host.

1. Connect the host computers to the USB host ports, as desired. Note that it is not required that both USB host ports be connected to host devices.
2. Login to the web server. Refer to [Logging in to the Web Server \(page 14\)](#) for more information.
3. Click **USB** in the menu bar, then click the **Follow USB** radio button.

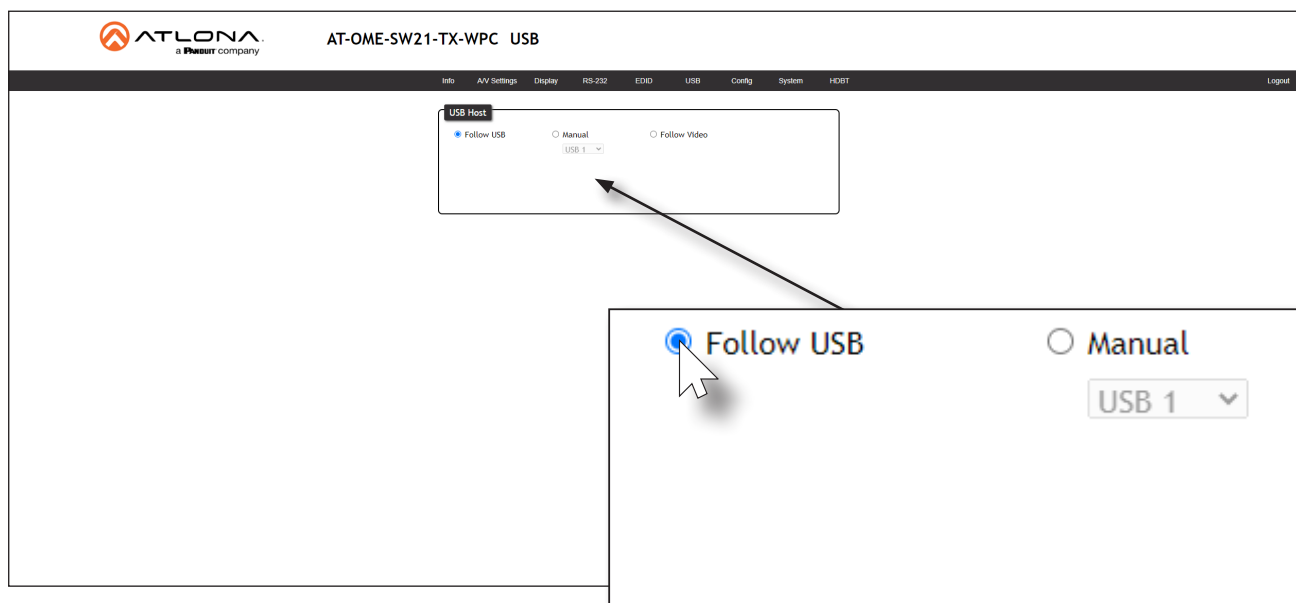

Once set to **Follow USB** mode, the AT-OME-SW21-TX-WPC will exhibit the following behavior:

- If only one USB host device is connected to the USB host ports, then the AT-OME-SW21-TX-WPC will use the USB host device connected to that port.
- If another USB host device is connected to a vacant USB host port, then the AT-OME-SW21-TX-WPC will automatically switch to that USB host device.
- If both the **HOST** and **USB-C** host ports are connected, then the AT-OME-SW21-TX-WPC will switch to the USB port that was connected last.
- If both the **HOST**, and **USB-C** host ports are connected, and one USB host port is *disconnected*, then the AT-OME-SW21-TX-WPC will automatically switch to the USB host port that was connected last.

Manual

This mode provides manual selection of the USB host port to be used.

1. Connect the host computers to the USB host ports, as desired. Note that it is not required that both USB host ports be connected to host devices.
2. Login to the web server. Refer to [Logging in to the Web Server \(page 14\)](#) for more information.
3. Click **USB** in the menu bar.
4. Click the **Manual** radio button.

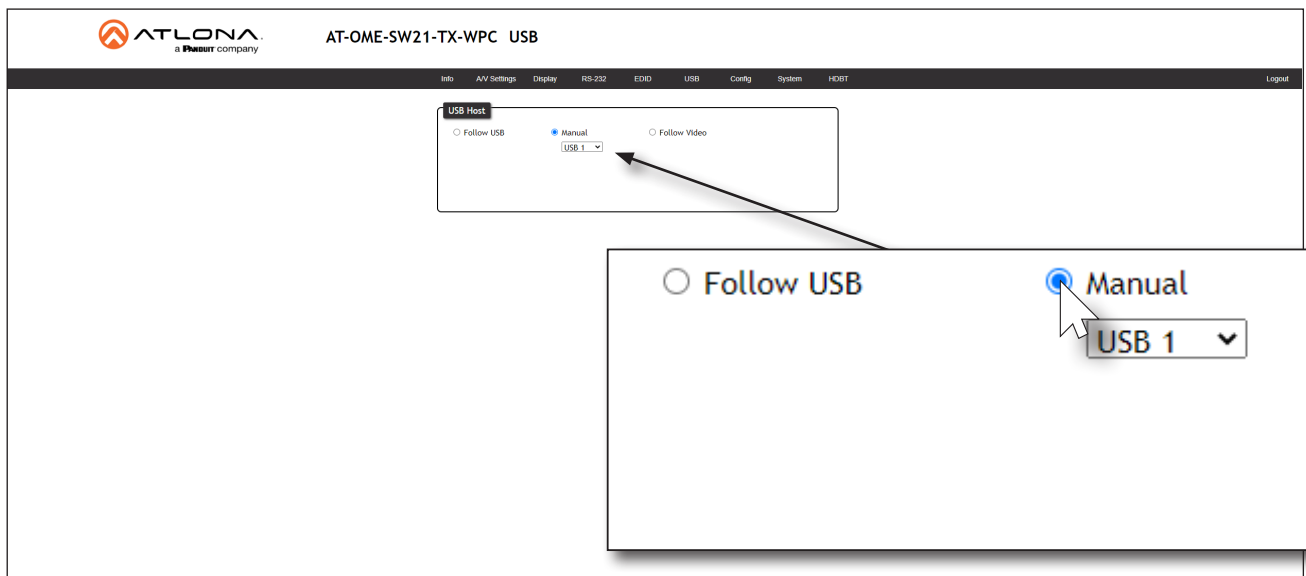

- Click the drop-down list, below the **Manual** radio button, to select the desired input.

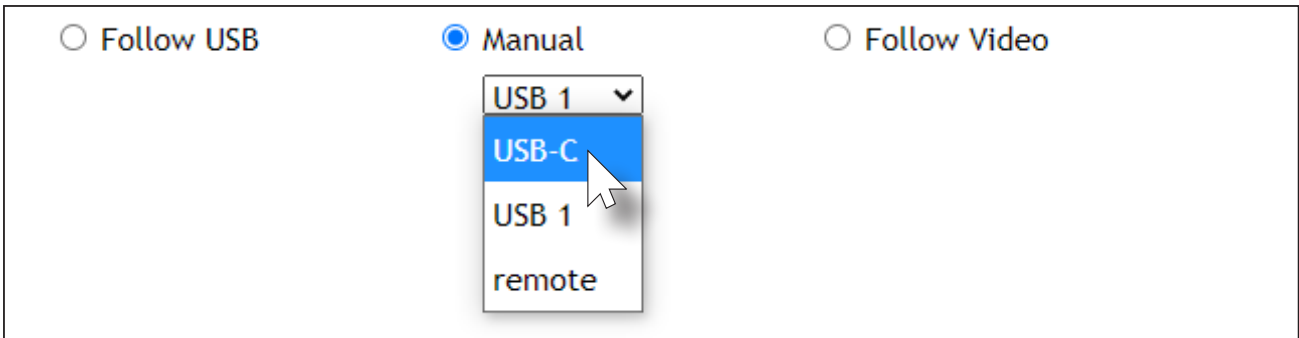

Follow USB
 Manual
 Follow Video

USB 1 ▾
USB-C
 USB 1
 remote

USB Host	Description
USB-C	USB-C port
USB 1	The HOST port
remote	Uses the USB host port on the HDBaseT receiver

- Manual USB configuration is complete.

Follow Video

In this mode, each video input can be assigned to either the **HOST** or **USB-C** port. Follow Video mode locks the USB host device to the desired video port. In this way, the video source will have access to all connected USB device, each time video switching occurs.

- Connect the host computers to the desired USB host ports. Note that it is not required that two USB host ports be connected to host devices.
- Login to the web server. Refer to [Logging in to the Web Server \(page 14\)](#) for more information.
- Click **USB** in the menu bar, then click the **Follow Video** radio button.

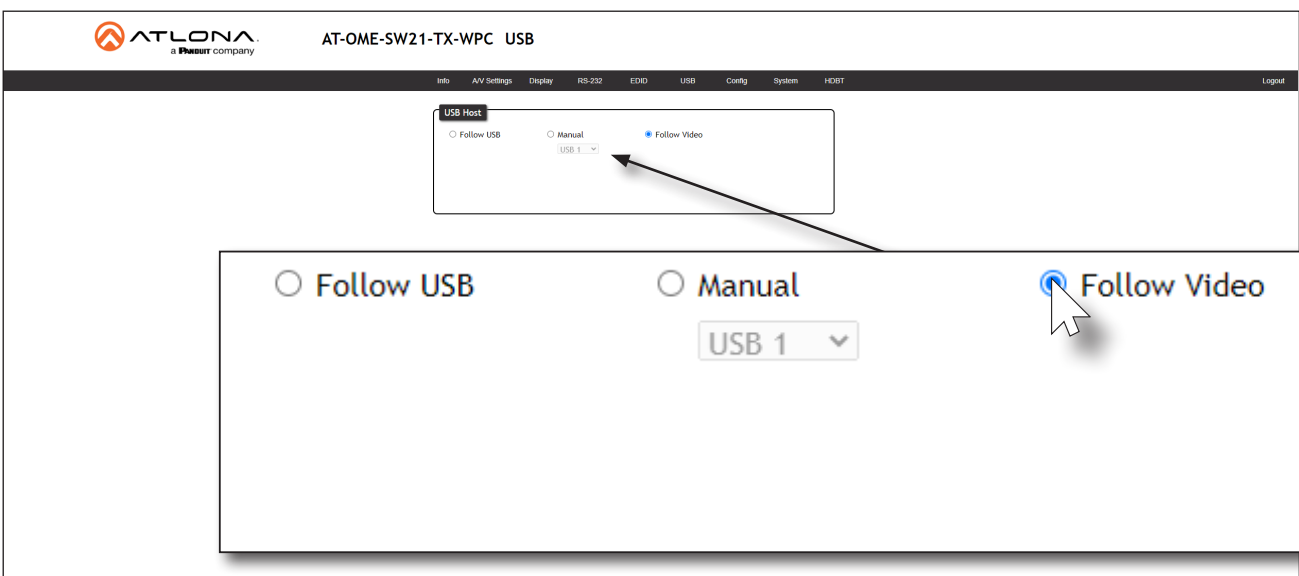

ATLONA a PANOUT company
 AT-OME-SW21-TX-WPC USB

Info AV Settings Display RS-232 EDID USB Config System HDBT Logout

USB Host

Follow USB
 Manual
 Follow Video

USB 1 ▾

Follow USB
 Manual
 Follow Video

USB 1 ▾

User Management

The AT-OME-SW21-TX-WPC allows the administrator password to be changed, as well as the ability to create and remove user accounts. Passwords apply to both the web server and Telnet sessions. All users have the same level of access to control the AT-OME-SW21-TX-WPC. However, only the administrator-level user is allowed to manage other users. Up to three additional users can be created.

Changing the Administrator Password

1. Login to the web server. Refer to [Logging in to the Web Server \(page 14\)](#) for more information.
2. Click **Config** in the menu bar.
3. Click the **Old Password** field and enter the current password.

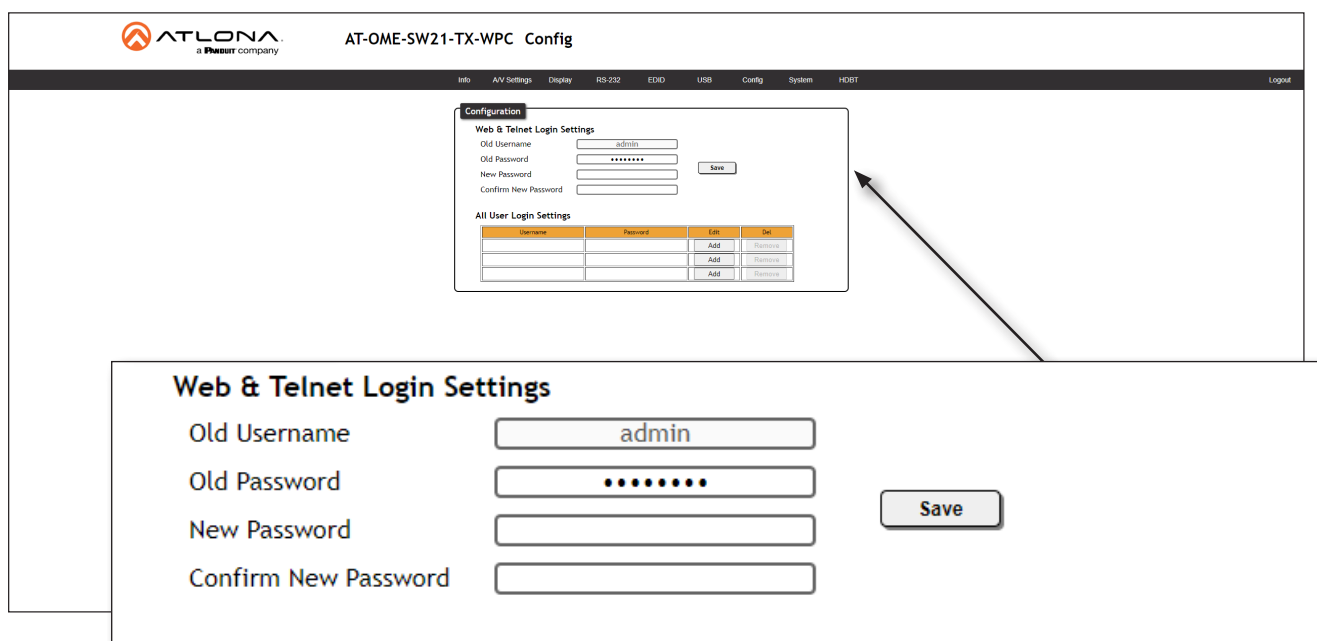

The screenshot shows the configuration page for the AT-OME-SW21-TX-WPC. The 'Web & Telnet Login Settings' section is highlighted with a callout box. The form contains the following fields and controls:

- Old Username:
- Old Password:
- New Password:
- Confirm New Password:
- Save button

Below this section, there is a table for 'All User Login Settings' with columns for Username, Password, Edit, and Del.

4. Enter the new password in the **New Password** field.
5. The EDID storing procedure is completed.
6. Retype the new password in the **Confirm New Password** field.
7. Click the **Save** button to commit changes. To login with the new username, click **Logout** in the upper-right corner of the screen, then enter the new password on the **Login** page.

NOTE: Password fields will always be masked for security purposes.

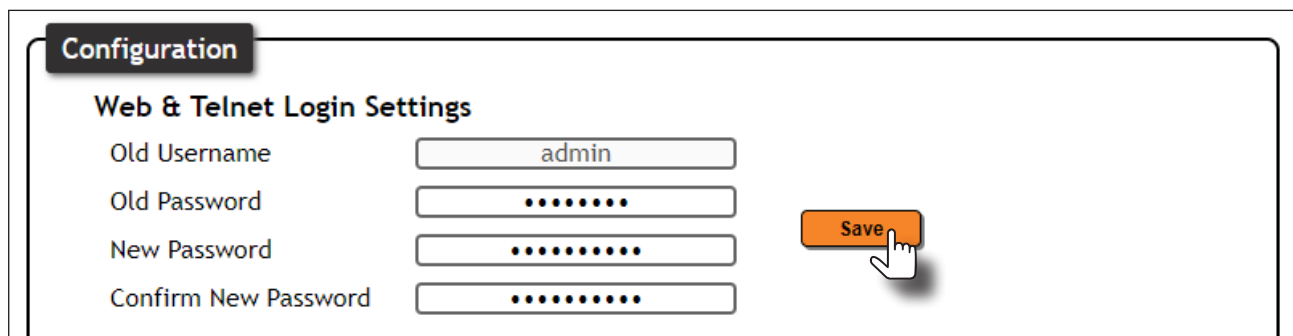

This close-up view of the 'Web & Telnet Login Settings' form shows the following details:

- Old Username:
- Old Password:
- New Password:
- Confirm New Password:
- Save button: A hand cursor is pointing to the orange 'Save' button.

Adding Users

1. Open the desired web browser and enter the IP address of the AT-OME-SW21-TX-WPC.
2. Login with the required credentials.
3. Click the **Config** tab.
4. Click the **Add** button, under the **Edit** column.

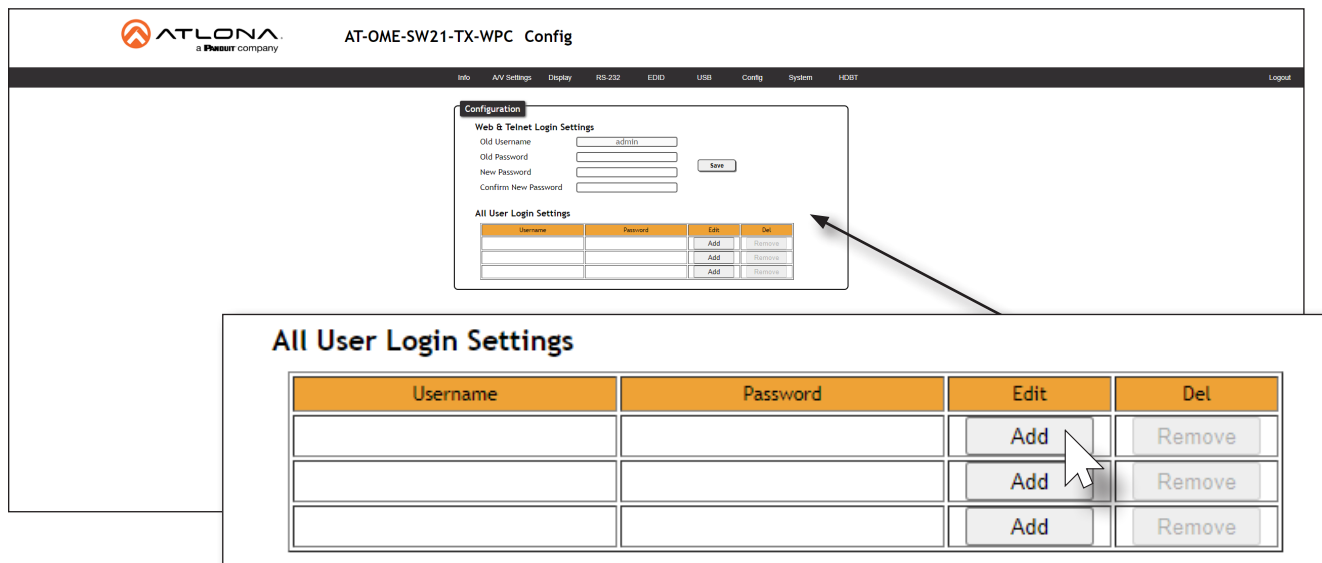

5. Enter the desired username and password in the **Username&Password Edit** dialog box.
6. Click the **Save Change** button to commit changes or click the **Cancel** button to return to the **Config** page without adding the user.

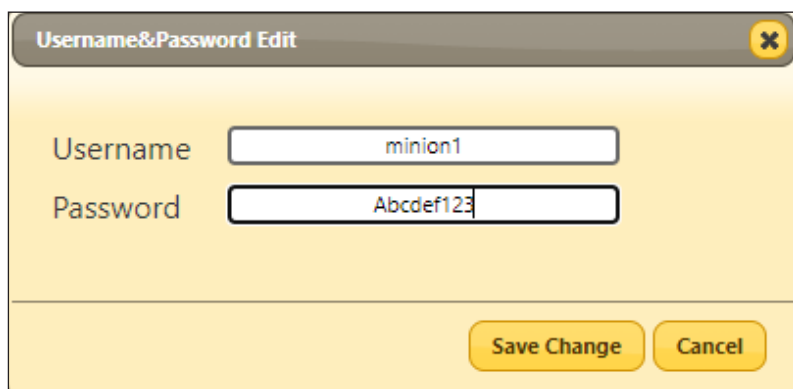

Once created, the new user and the associated password will appear under the **All User Login Settings** section. To login with the new username, click **Logout** in the upper-right corner of the screen, then enter the login credentials for the user on the **Login** page.

Editing / Deleting Users

The username and password of a user can be changed using this method.

1. Open the desired web browser and enter the IP address of the AT-OME-SW21-TX-WPC.
2. Login with the administrator credentials. The administrator username and password are the credentials which were created during the registration process.

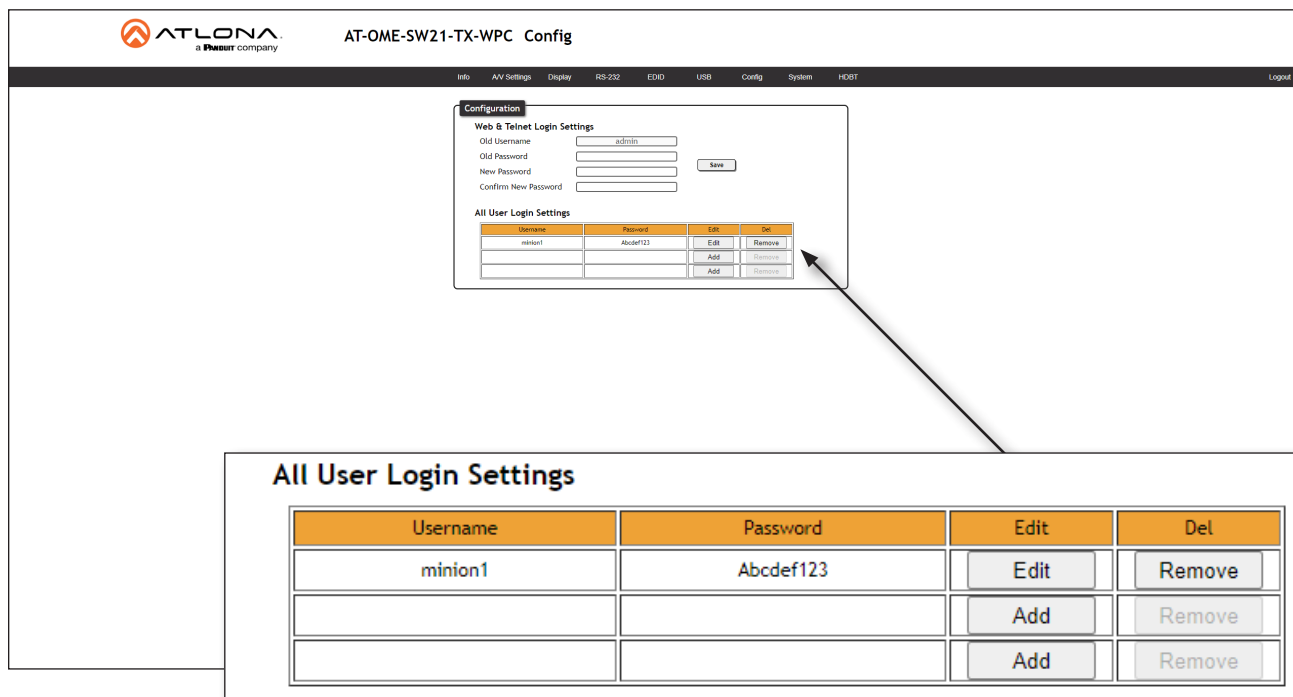

The screenshot shows the configuration page for AT-OME-SW21-TX-WPC. It features a navigation menu with tabs: Info, AV Settings, Display, RS-232, EDID, USB, Config, System, and HDBT. The main content area is titled 'Configuration' and contains two sections:

- Web & Telnet Login Settings:** Includes input fields for 'Old Username' (pre-filled with 'admin'), 'Old Password', 'New Password', and 'Confirm New Password', along with a 'Save' button.
- All User Login Settings:** A table with columns for Username, Password, Edit, and Del. The first row shows 'minion1' with password 'Abcdef123'. Below the table are 'Add' and 'Remove' buttons for each row.

An arrow points from the 'Edit' button in the 'All User Login Settings' table to a larger, detailed view of the 'All User Login Settings' table below.

Username	Password	Edit	Del
minion1	Abcdef123	Edit	Remove
		Add	Remove
		Add	Remove

Editing Users

- a. Click the **Config** tab.
- b. Click the **Edit** button next to the user to be changed.
- c. Enter the new information for the user in the **Username&Password Edit** dialog box.
- d. Click the **Save Change** button to commit changes or click the **Cancel** button to return to the **Config** page without making changes.

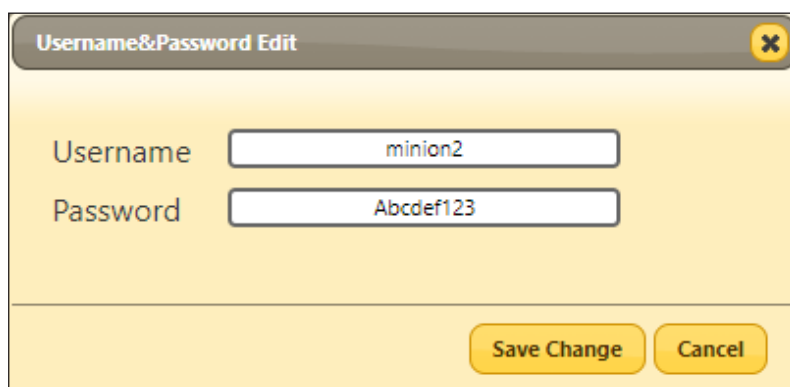

The dialog box is titled 'Username&Password Edit' and has a close button (X) in the top right corner. It contains two input fields:

- Username:** A text box containing 'minion2'.
- Password:** A text box containing 'Abcdef123'.

At the bottom of the dialog, there are two buttons: 'Save Change' and 'Cancel'.

Deleting Users

- a. Click the **Remove** button next to the user to be deleted.

System Configuration

The AT-OME-SW21-TX-WPC provides easy access to system configuration through the built-in web server, and is the recommended method to adjust network settings.

Setting the IP Mode

1. Login to the web server. Refer to [Logging in to the Web Server \(page 14\)](#) for more information.
2. Click **System** in the menu bar.
3. Click the **IP Mode** toggle to the desired setting. The default setting is **DHCP**.

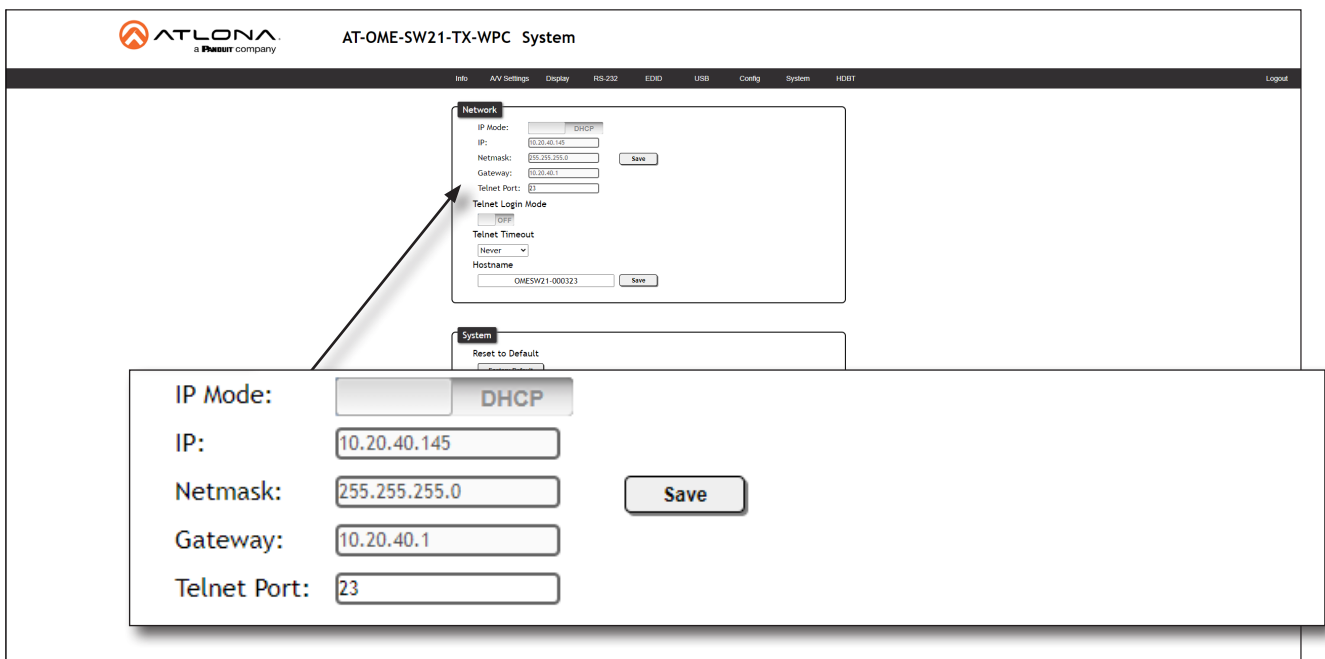

If a *static IP* address is desired, do the following:

- a. Click the **IP Mode** toggle to **STATIC IP**.
 - b. Enter the desired IP address, subnet mask, and gateway, in the **IP**, **Network**, and **Gateway** fields, respectively.
 - c. Click the **Save** button.
4. IP mode configuration is complete.

Changing the Telnet Port

Typically, the Telnet service is assigned to TCP port 23. This is the default setting for the AT-OME-SW21-TX-WPC. However, depending upon the network environment, the default Telnet port can be changed.

1. Login to the web server. Refer to [Logging in to the Web Server \(page 14\)](#) for more information.
2. Click **System** in the menu bar.
3. Locate the **Telnet Port** field and enter the desired port in the field.
4. Click **Save** to commit changes.

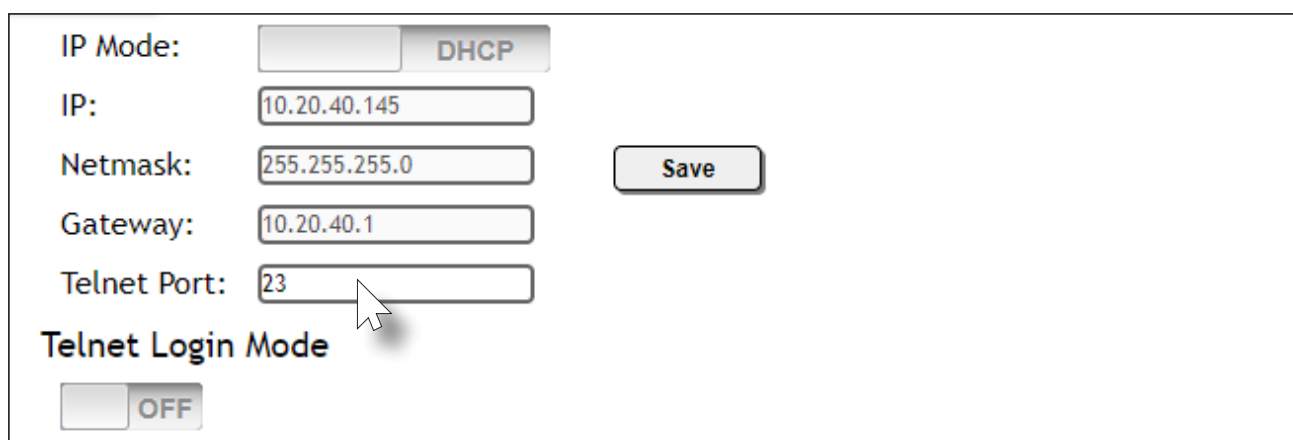

IP Mode: DHCP

IP:

Netmask:

Gateway:

Telnet Port:

Telnet Login Mode

OFF

Telnet Login Mode

When a Telnet session is request, the AT-OME-SW21-TX-WPC provides the option to prompt for user credentials or bypass authentication before the Telnet session begins. This credentials prompt option can enabled or disabled. When prompting for user credentials, use the same login information required by the built-in web server.

1. Login to the web server. Refer to [Logging in to the Web Server \(page 14\)](#) for more information.
2. Click **System** in the menu bar.
3. Click the **Telnet Login Mode** toggle switch.
 - Set this toggle switch to **ON** to prompt for user credentials.
 - Set this toggle switch to **OFF** to bypass user credentials request.
4. Click **Save** to commit changes.



Telnet Login Mode

ON OFF

Telnet Timeout

▼

Adjusting Telnet Timeout

When a Telnet session is active, the AT-OME-SW21-TX-WPC can be set to monitor Telnet activity. If there is no activity within the specified time interval, the Telnet session will automatically be terminated, adding a measure of security.

1. Login to the web server. Refer to [Logging in to the Web Server \(page 14\)](#) for more information.
2. Click **System** in the menu bar.
3. Click the **Telnet Timeout** drop-down list and select the desired time-out interval. Values from 10 to 3600 seconds can be selected.



IMPORTANT: If **Never** is selected, then the Telnet port will stay open until the Telnet session is manually terminated.

4. Click **Save** to commit changes.

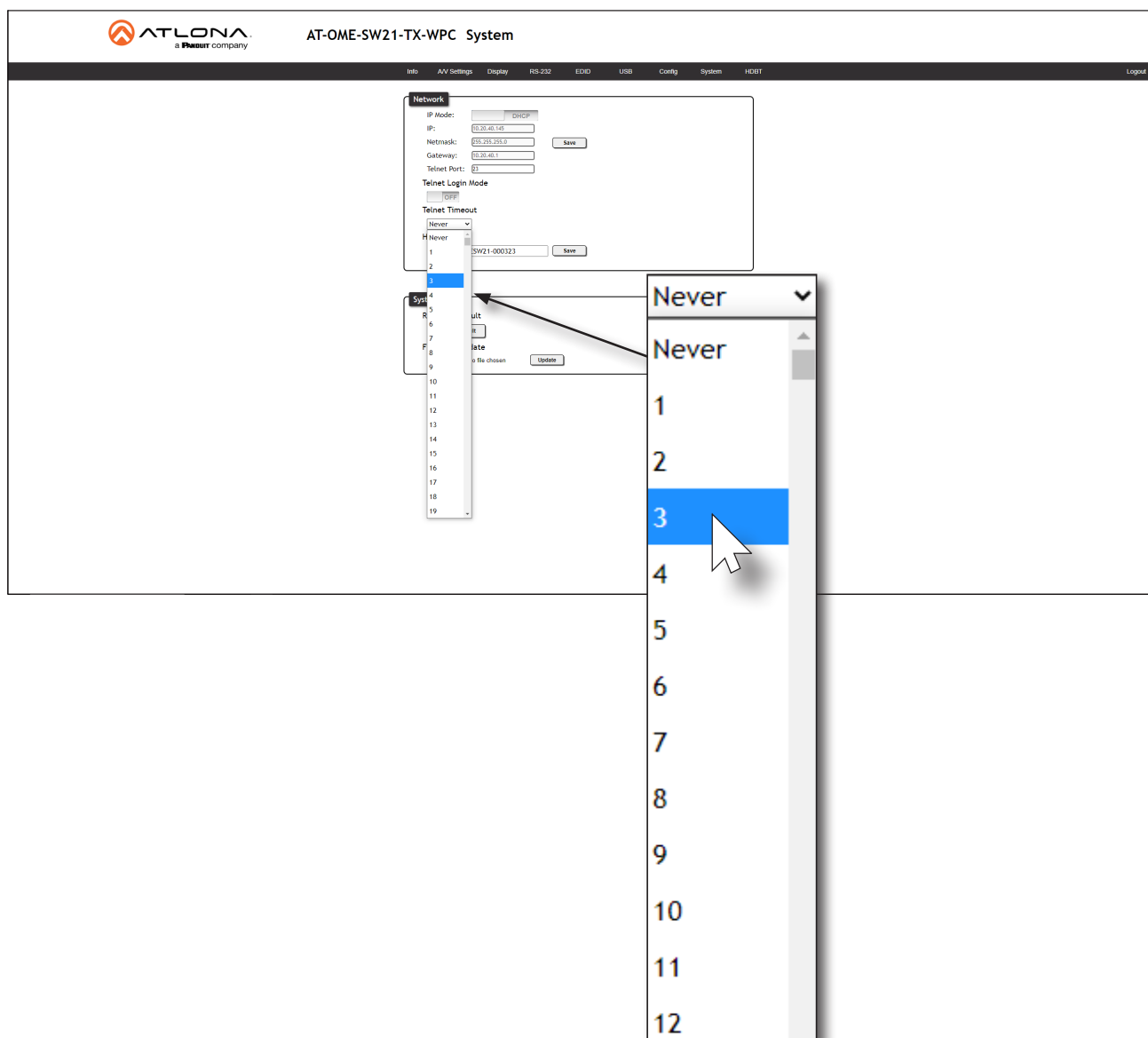

Setting the Host Name

By default, the AT-OME-SW21-TX-WPC is assigned a hostname, which is constructed as follows:

OMESW21-[last six digits of MAC address]

For example, a default hostname might look like this: OMESW21-000323. This value can be changed to easily identify the AT-OME-SW21-TX-WPC within the Atlona Management System (AMS) or a network. If using a custom hostname, it must meet the hostname standards, defined here: <https://tools.ietf.org/html/rfc1123>

1. Login to the web server. Refer to [Logging in to the Web Server \(page 14\)](#) for more information.
2. Click **System** in the menu bar.
3. Click the **Hostname** field and enter the desired name.
4. Click **Save** to commit changes.

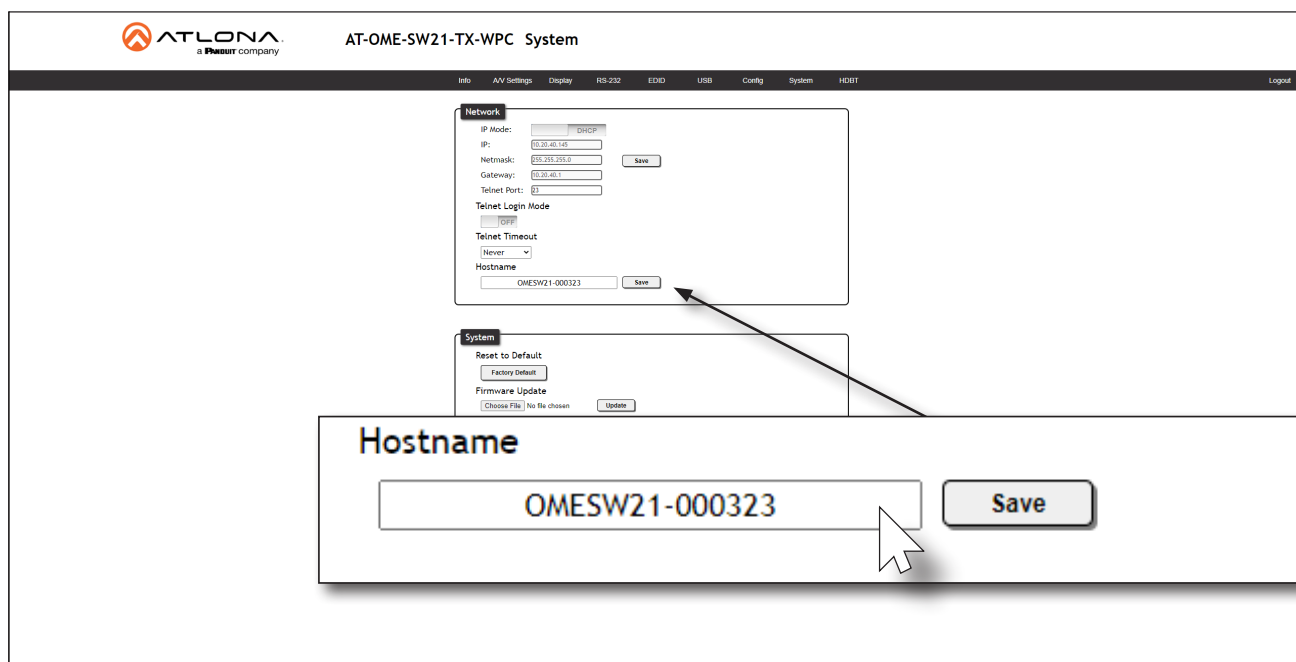

Resetting to Factory-Default Settings

The following procedure will reset the AT-OME-SW21-TX-WPC to factory-default settings. The network IP mode will be set to DHCP mode.

1. Login to the web server. Refer to [Logging in to the Web Server \(page 14\)](#) for more information.
2. Click **System** in the menu bar.
3. Click the **Factory Default** button.

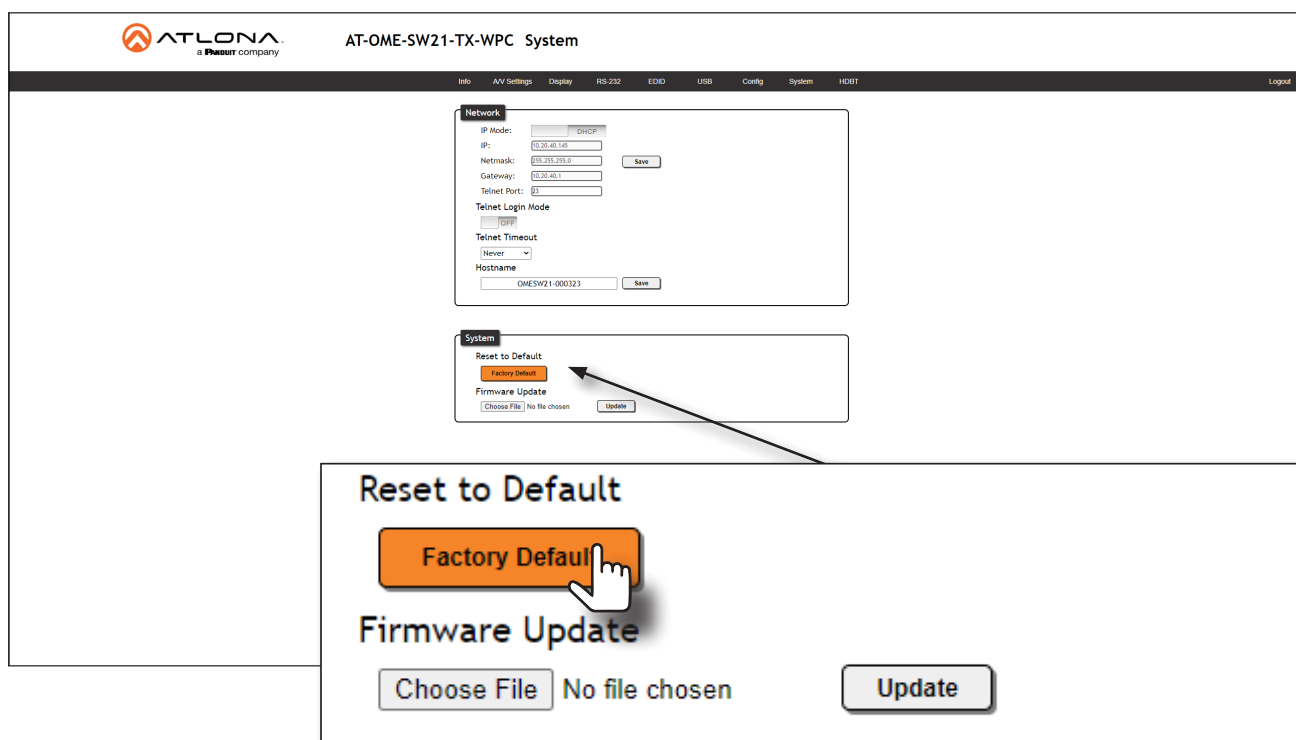

4. The following message will be displayed at the top of the screen. Click **OK** to continue with the factory-default reset procedure. Click **Cancel** to abort the process.

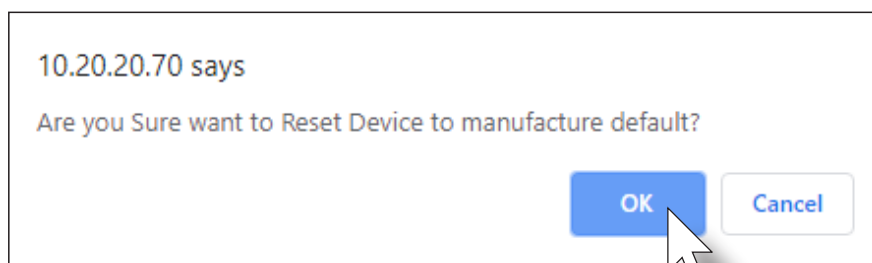

5. Once the factory-default process is complete, the web server **Login** screen will be displayed.
6. The reset process is complete.

HDBaseT Testing

The web server of the AT-OME-SW21-TX-WPC provides a tool for testing the signal integrity of HDBaseT cables. This tool is useful for troubleshooting and identifying defective or damaged category cables which are connected from the HDBaseT OUT port on the AT-OME-SW21-TX-WPC to a compatible receiver.

1. Login to the web server. Refer to [Logging in to the Web Server \(page 14\)](#) for more information.
2. Click **HDBT** in the top menu bar.
3. Make sure that a category cable (CAT-5e or better) is connected between the **HDBaseT OUT** port of the AT-OME-SW21-TX-WPC and a compatible receiver.

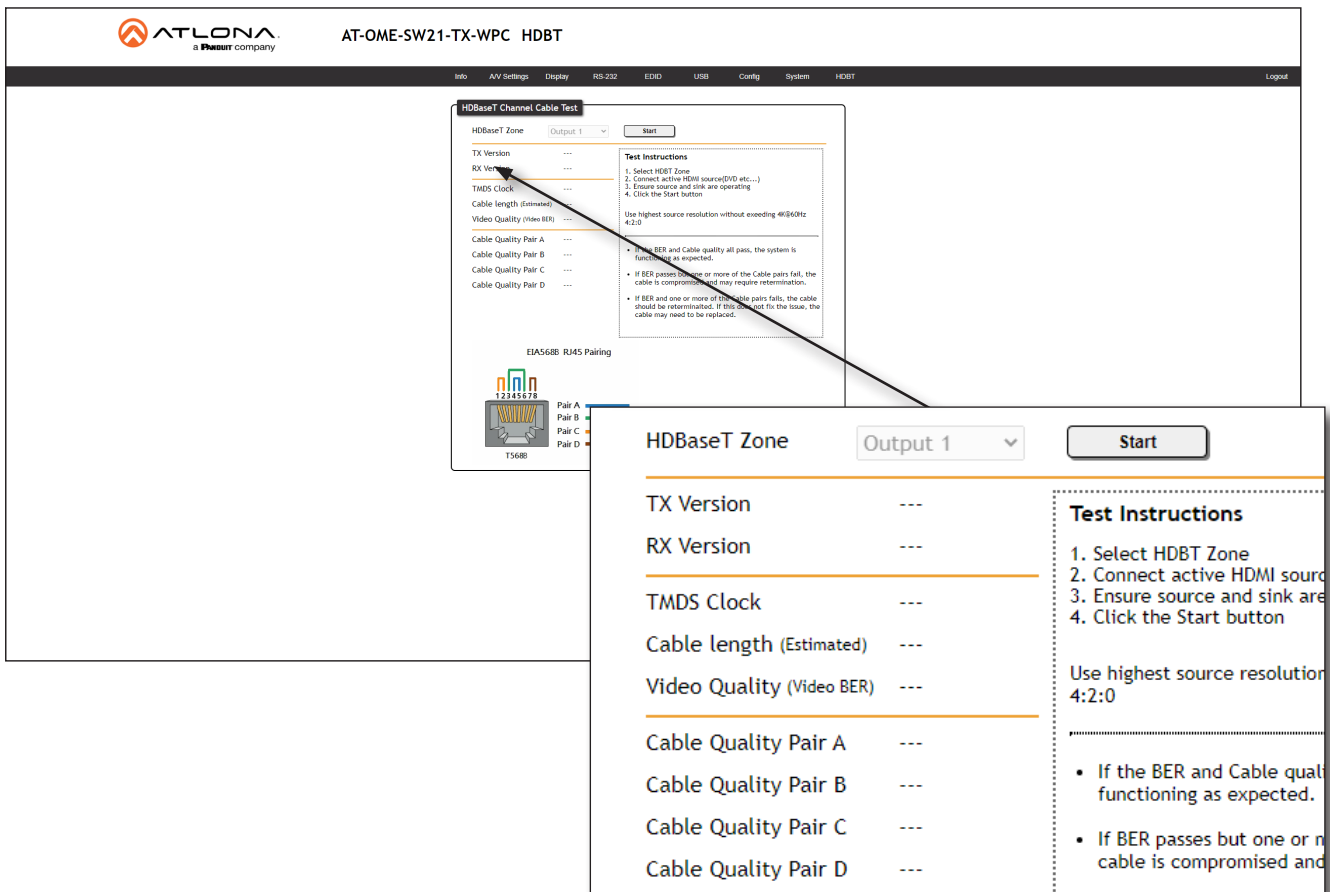

4. Click the **Start** button to begin testing the channel.
 - If the HDBaseT link integrity is good, then all tests will display as “Pass”.
 - If any part of the HDBaseT cable fails, then a numerical value, in decibels, will be displayed next to the associated pair, under the **Signal Quality** section. These values can be reported to Atlona Technical Support Engineers to help resolve possible issues.

Configuration and Management Interfaces

Web Server

The AT-OME-SW21-TX-WPC includes a built-in web server. Atlona recommends that the web server be used to set up the AT-OME-SW21-TX-WPC, as it provides intuitive management of all features.

Info Page

The **Info** page provides various information about the AT-OME-SW21-TX-WPC, including software version and video information.

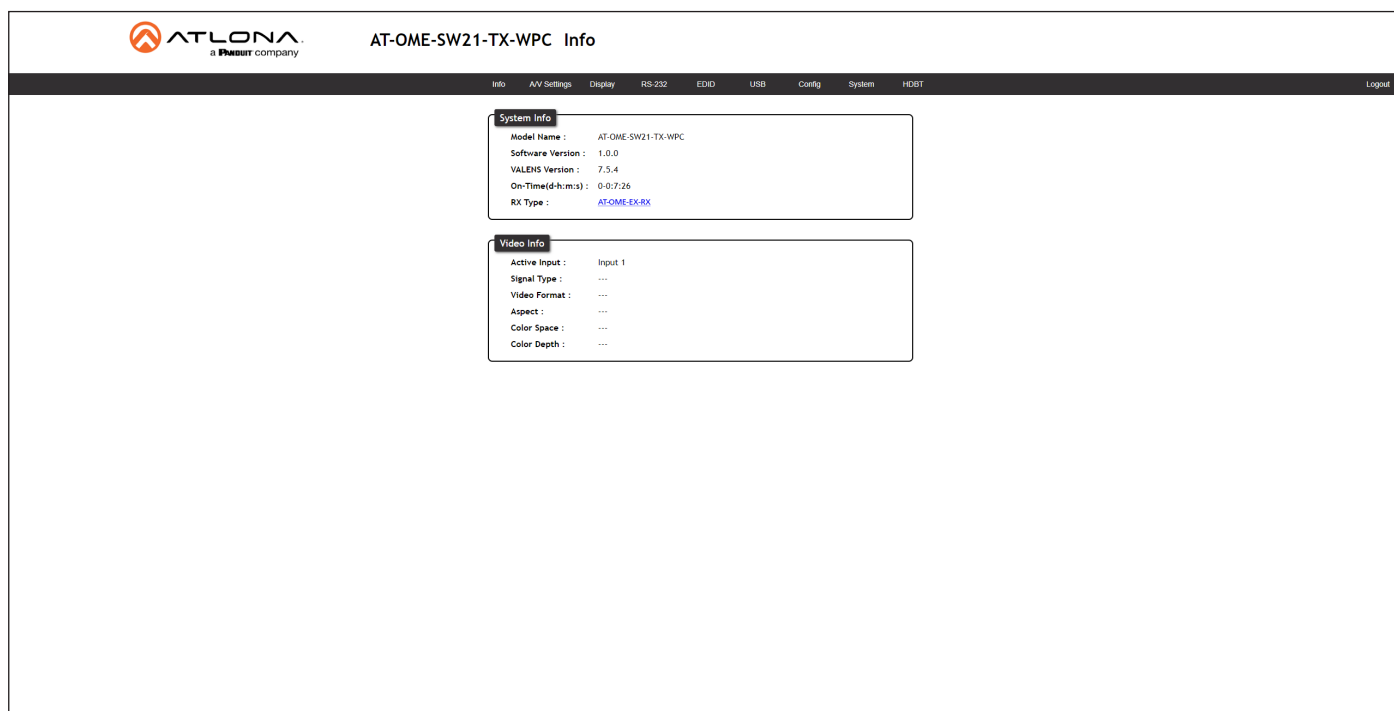

System Info

Model Name

The model SKU of this product.

Software Version

The version of firmware that the AT-OME-SW21-TX-WPC is running. Always make sure to check the AT-OME-SW21-TX-WPC product page, on the Atlona web site, for the latest version of firmware.

VALENS Version

Displays the firmware version of the VALENS chipset.

On-Time(d-h:m:s)

Displays how long the system has been powered since the last reboot/reset.

RX Type

Displays the HDBaseT receiver that is connected to the AT-OME-SW21-TX-WPC. If identification of the remote receiver fails, then "general" will be displayed.

Version Info

Active Input

The currently selected (active) input.

Signal Type

The type of input signal.

Video Format

The input resolution of the source device.

Aspect

Aspect ratio of the input signal.

Color Space

Displays the color space and chroma sub-sampling of the input signal.

Color Depth

The color depth of the input signal.

AV Settings Page

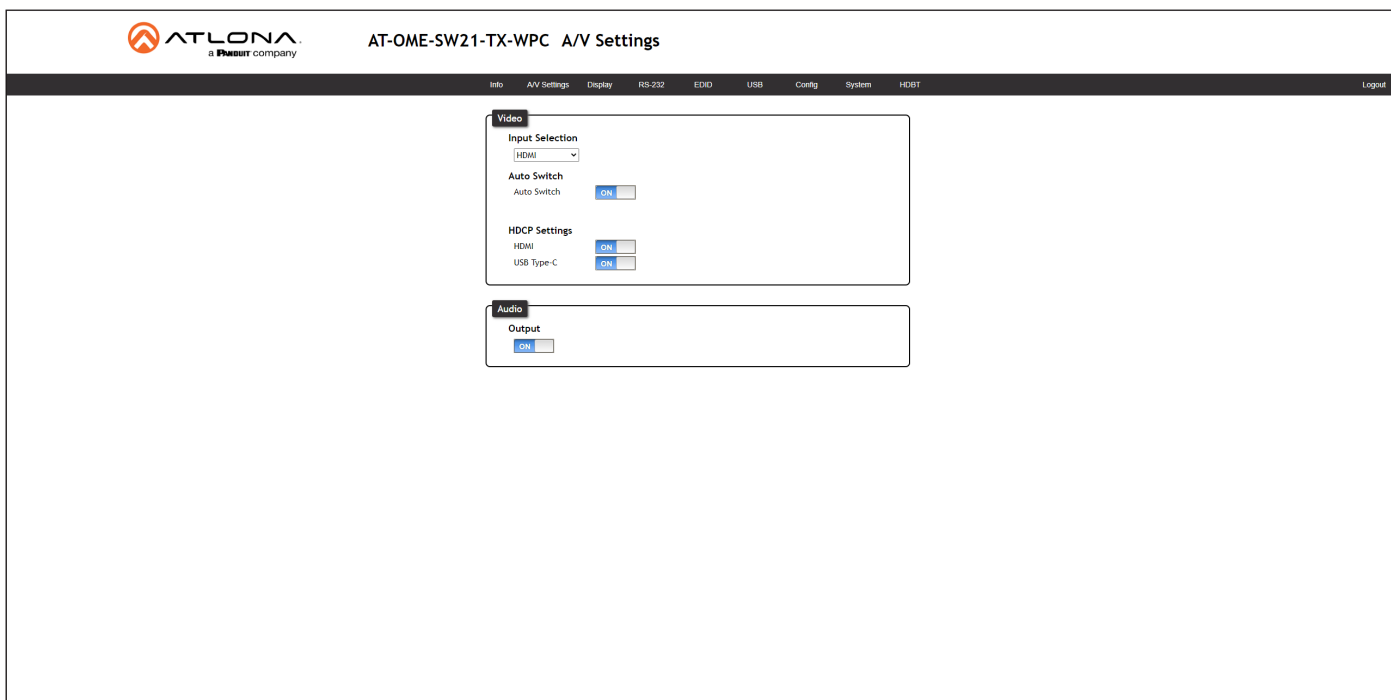

Video

Input Selection

Click the drop-down list to select the desired input.

Setting	Description
HDMI	Switches to the source connected to the HDMI port.
USB Type C	Switches to the source connected to the USB-C port.

Auto Switch

Click the **Auto Switch mode** toggle to enable or disable auto-switching. If a source is disconnected from the active port, then the switcher will automatically switch the opposite port. This feature is enabled by default.

HDCP Settings

Sets the HDCP reporting mode of the specified port. Some devices will automatically transmit HDCP content if an HDCP-compliant display/sink is detected. Setting this value to **OFF**, will instruct the source to send non-HDCP content (if possible) to non-HDCP display and/or sink devices. Note that setting this value to **OFF** will not decrypt HDCP content.

Setting	Description
ON	HDCP content is always transmitted by the source
OFF	Instructs the source to send non-HDCP content, if possible

Audio

Output

Mutes or un-mutes the audio output. Set the **Output** toggle to OFF to disable audio on the output. The default setting is ON.

Display Page

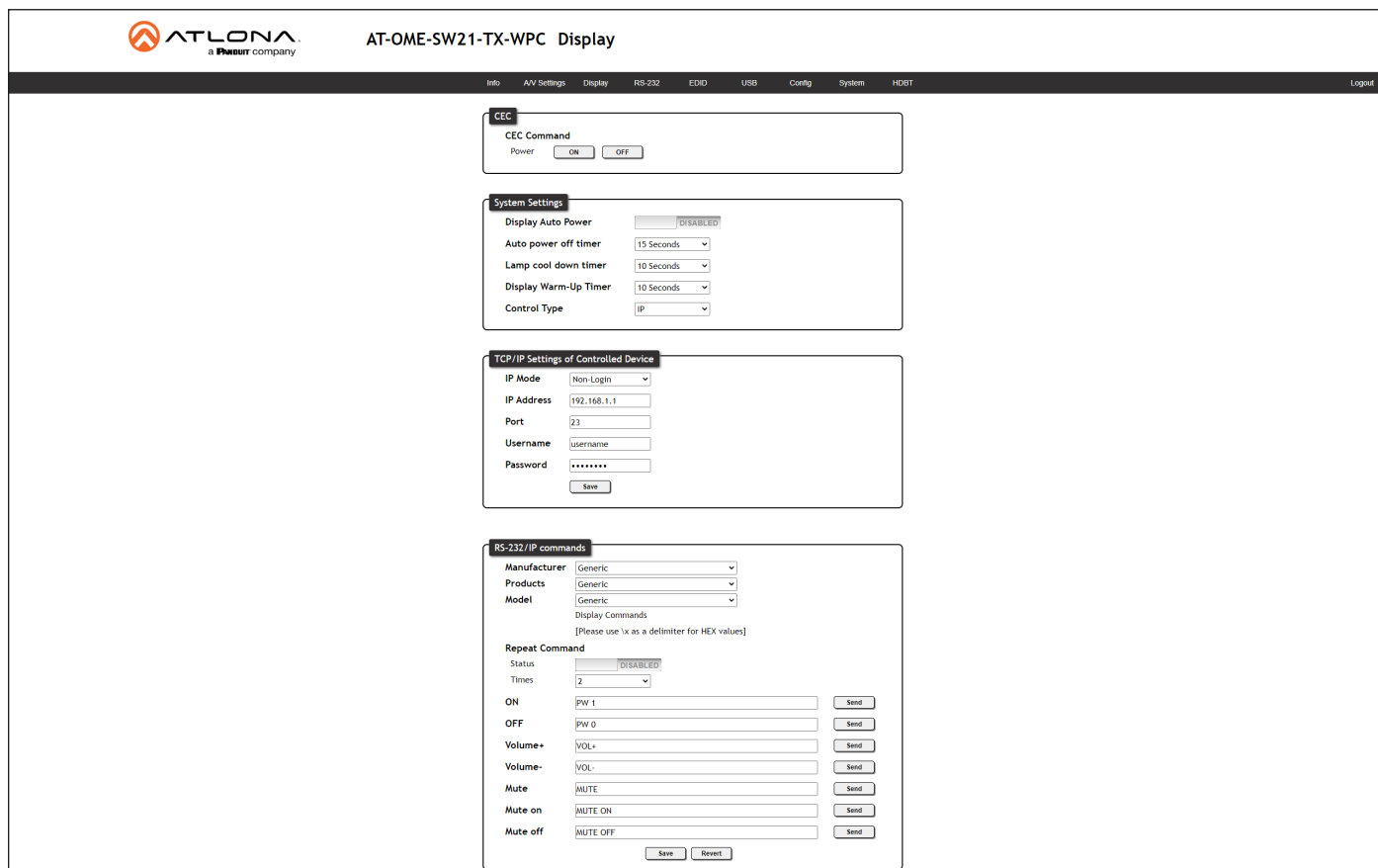

CEC

CEC Command

Click the **ON** button to send the power-on command to the display device. Click the **OFF** button to toggle the power state to off.

System Settings

Display Auto Power On

Click the toggle switch to the **ENABLE** position to send the command to power-on the display, when an A/V signal is detected. Otherwise, set to **DISABLE** to turn this feature off.

Auto power off timer

Click this drop-down to select the time interval before the command to power-off the display is sent, when an A/V signal is no longer present. The default value is 15 seconds. Available values are 15 seconds to 15 minutes.

Lamp cool down timer (Sec.)

Sets the cool-down interval, in seconds, before the projector can be powered-off. During this time interval, the projector will not accept any “power on” or “power off” commands until the last “power off” command has been processed and the projector lamp has completed the cool-down cycle. Range: 0 to 300.

Display Warm-Up Timer

Click this drop-down list to set the projector lamp warm-up timer, in seconds. During the warm-up interval, the AT-OME-SW21-TX-WPC will not start the auto power-off timer. This value specifies the time interval that must elapse, after the display control “on” command is sent, before the display “power off” command can be sent. This feature is used to prevent a “power off” command from being sent while the lamps are warming up. Available values are 10 seconds to 300 seconds.

Configuration and Management Interfaces

Control Type

Sets the control method for sending commands. The following options are available: RS-232, IP, CEC.

Setting	Description
RS-232	RS-232 over HDBaseT is used to send commands.
IP	Commands are sent over IP.
CEC	Uses CEC to send commands.

TCP/IP Settings of Controlled Device

These settings are only displayed when the **Control Type** is set to **IP**.

IP Mode

Click this drop-down list to select the login mode.

Setting	Description
Non-login	Does not require a username and password when using TCP/IP to control the display.
Login	Requires a username and password to control the display through TCP/IP.

IP Address

Enter the IP address of the display/device in this field.

Port

Enter the listening port of the display/device in this field.

Username

Enter the username for login. If the **IP Mode** is set to Non-Login, then this information will not be required.

Password

Enter the password for login. If the **IP Mode** is set to Non-Login, then this information will not be required.

Save

Click this button to save all changes in this window group.

Configuration and Management Interfaces

RS-232 / IP Commands

This section is only available when the **Control Type** is set to either **RS-232** or **IP**.

Manufacturer

Click this drop-down list to select the display manufacturer. If the display device being controlled is not in this list, then select **Generic** and enter the commands manually.

Generic	Hitachi	Qomo
Acer	Infocus	Samsung
Barco	LG	Sharp
Benq	NEC	Sony
Canon	Optima	Toshiba
Casio	Panasonic	ViewSonic
Eiki	Pjlink	Vivitek
Epson	Planar	

Products

Click this drop-down list to select the product. The options available within this drop-down list are dependent upon the selected value in the **Manufacturer** drop-down list.

Model

Click this drop-down list to select the model. The options available within this drop-down list are dependent upon the selected value in the **Products** drop-down list.

Repeat Command

- Status**
 Click this toggle switch to set to **ENABLE** or **DISABLED**. Enabling this feature will re-send the command. Specify the number of times that the command is transmitted by setting the **Times** value. This feature is set to **DISABLED** by default.
- Times**
 Click this drop-down list to specify the number of times the command is sent. When the **Status** toggle switch is set to **ENABLE**, the default number of times is set to 2.

ON, OFF, Volume+, Volume-, Mute, Mute on, Mute off

These fields will need to be populated with the correct strings (either hex or ASCII format) for each function, which control the display device. If hexadecimal values are used, then use the /x delimiter at the end of the command string.

Save

Click this button to commit changes.

Revert

Click this button to undo changes to any pre-configured strings.

RS-232 Page

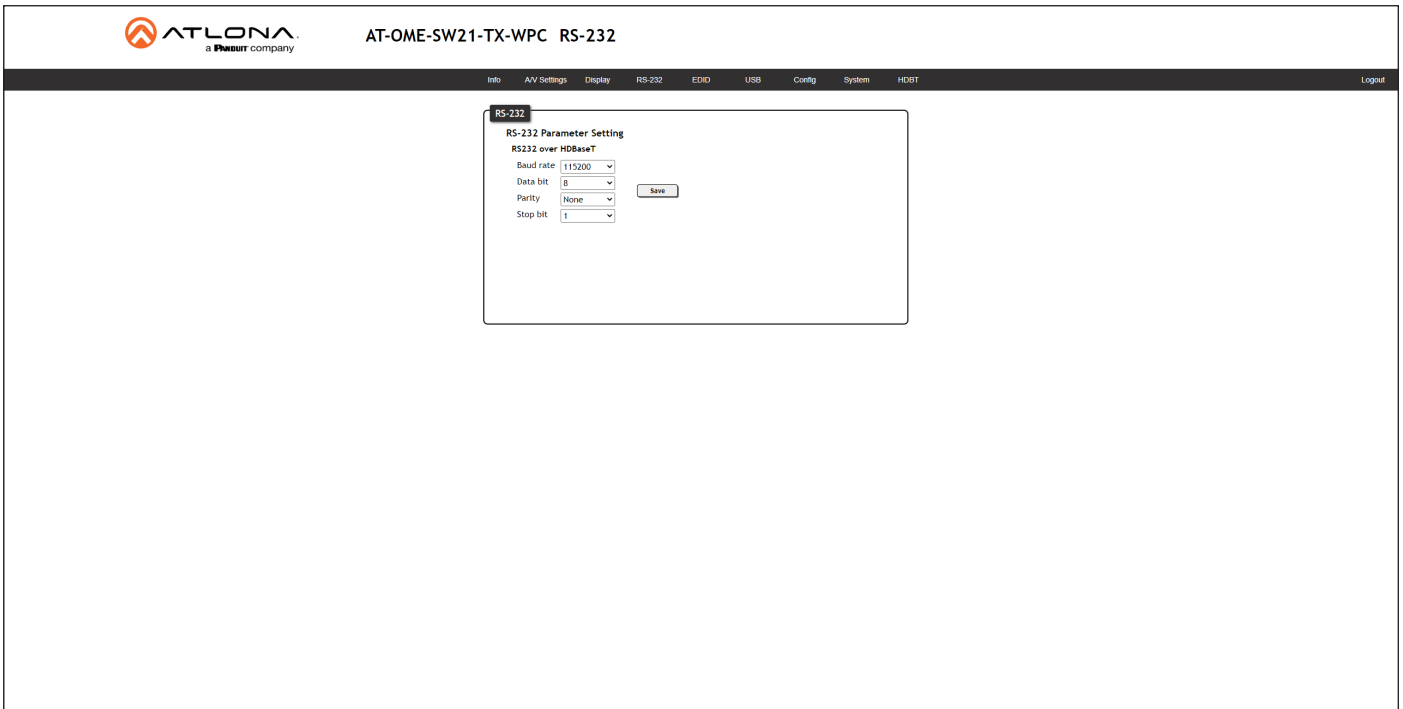

RS232 over HDBaseT

If the AT-OME-SW21-TX-WPC is connected to another HDBaseT device, such as the AT-OME-EX-RX, each of these drop-down list boxes can be set to the baud rate of the HDBaseT RS-232 settings on the corresponding device. Click the **Save** button to accept the settings.



NOTE: Changing RS-232 settings should only be performed when the HDBaseT receiver is an unmanaged device, such as the AT-OME-EX-RX. Changing RS-232 settings in the OME-SW21-TX-WPC are reflected on the output of the AT-OME-EX-RX RS232 port.

Setting	Description
Baud rate	Sets the baud rate. The following options are available: 2400, 9600, 19200, 38400, 56000, 57600, 115200.
Data bit	Sets the number of data bits used to represent each character of data. The following options are available: 7 or 8.
Parity	Sets the parity bit, which can be included with each character to detect errors during the transmission of data. The following options are available: None, Odd, or Even.
Stop bit	Sets the stop bit. Stop bits are sent at the end of each character, allowing the client to detect the end of a character stream. The following options are available: 1 or 2.

EDID Page

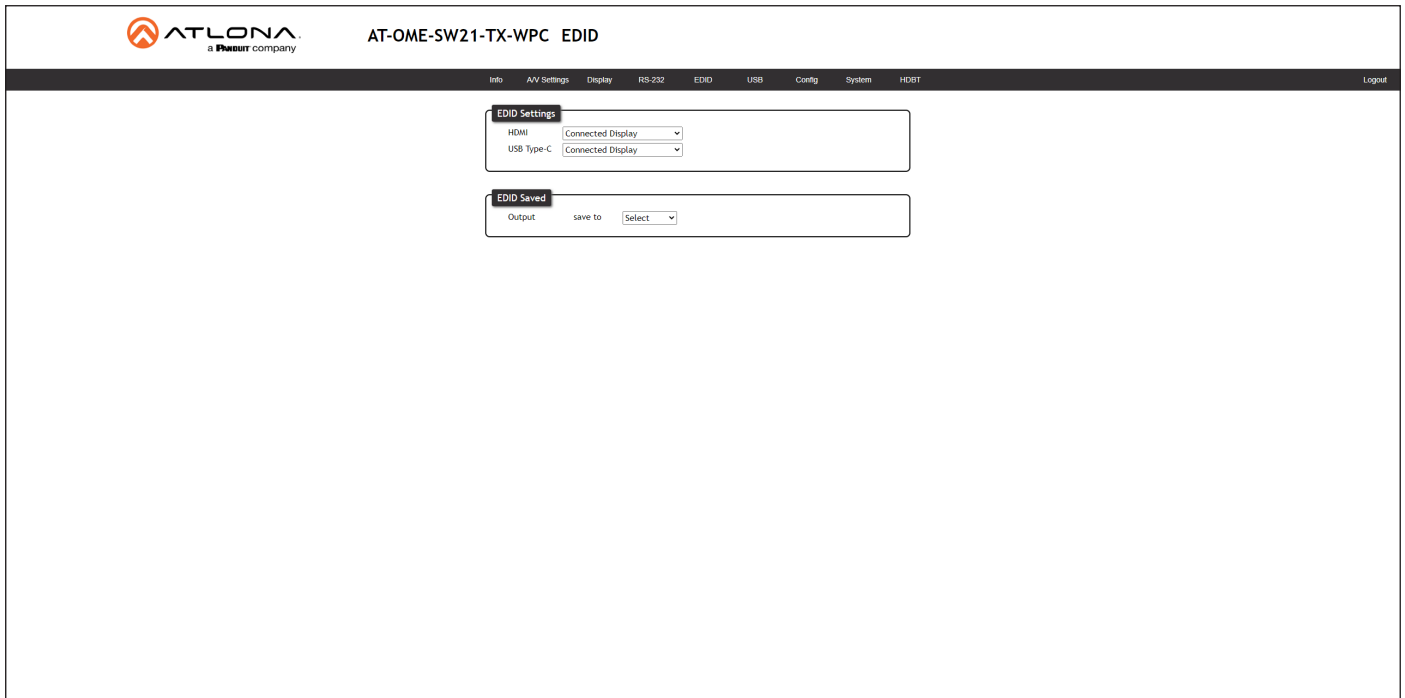

EDID Settings

HDMI / USB Type-C

Click these drop-down lists to select the desired EDID to be used for each input. The source device will use the information in the EDID, before sending A/V data to the sink device. The **Non saved** entries in the table, below, are used for storing custom EDID data.

Available EDID Selections			
Connected Display	1080P DD	3840x2160@30 4:4:4 2CH	1366x768 2CH
720P 2CH	1080P 3D 2CH	3840x2160@60 4:4:4 MCH	1920x1200 2CH
720P DD	1080P 3D MCH	4096x2160@60 4:2:0 2CH	Non saved
1080p DVI	1080P 3D DD	4096x2160@60 4:2:0 MCH	Non saved
1080P 2CH	3840x2160@60 4:2:0 2CH	1280x800 2CH	
1080P MCH	3840x2160@60 4:2:0 MCH	1280x800 DVI	

EDID Saved

Output

Click this drop-down list to select the memory location to save the downstream EDID. Two memory locations are available. Once an EDID is saved to a memory location, it can be access from the **EDID Settings** drop-down lists.

Configuration and Management Interfaces

USB Page

This page provides controls for setting the behavior of USB host switching. Refer to [USB Modes \(page 24\)](#) for more information.

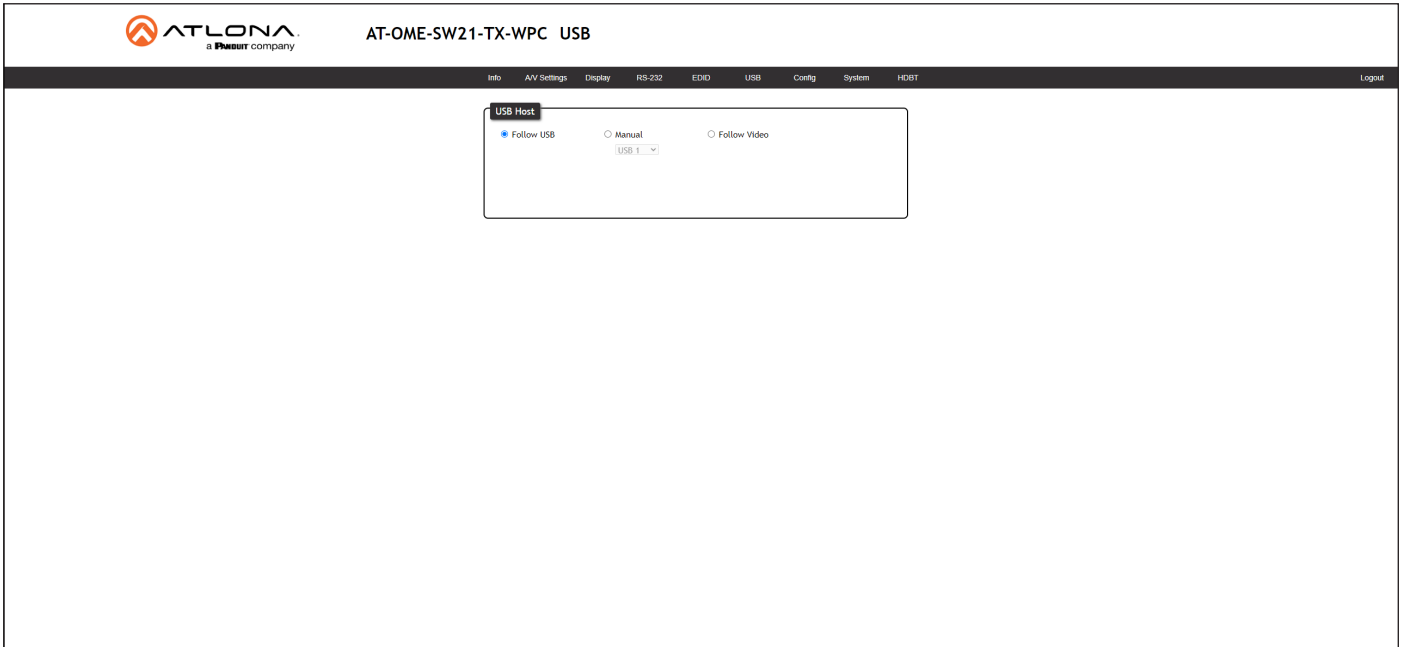

USB Host

Follow USB

This is the default mode and functions similar to auto-switching for video. In this mode, the AT-OME-SW21-TX-WPC will detect which USB ports are connected to a host device. If both USB host ports are connected to host devices, then the AT-OME-SW21-TX-WPC will set the last-connected USB host device as the “active” USB host.

Manual

This mode provides manual selection of the USB host port to be used.

Follow Video

In this mode, each video input will follow the USB host device connected to the HOST port. Each host device will have access to the same USB devices, when video switching occurs.

Config Page

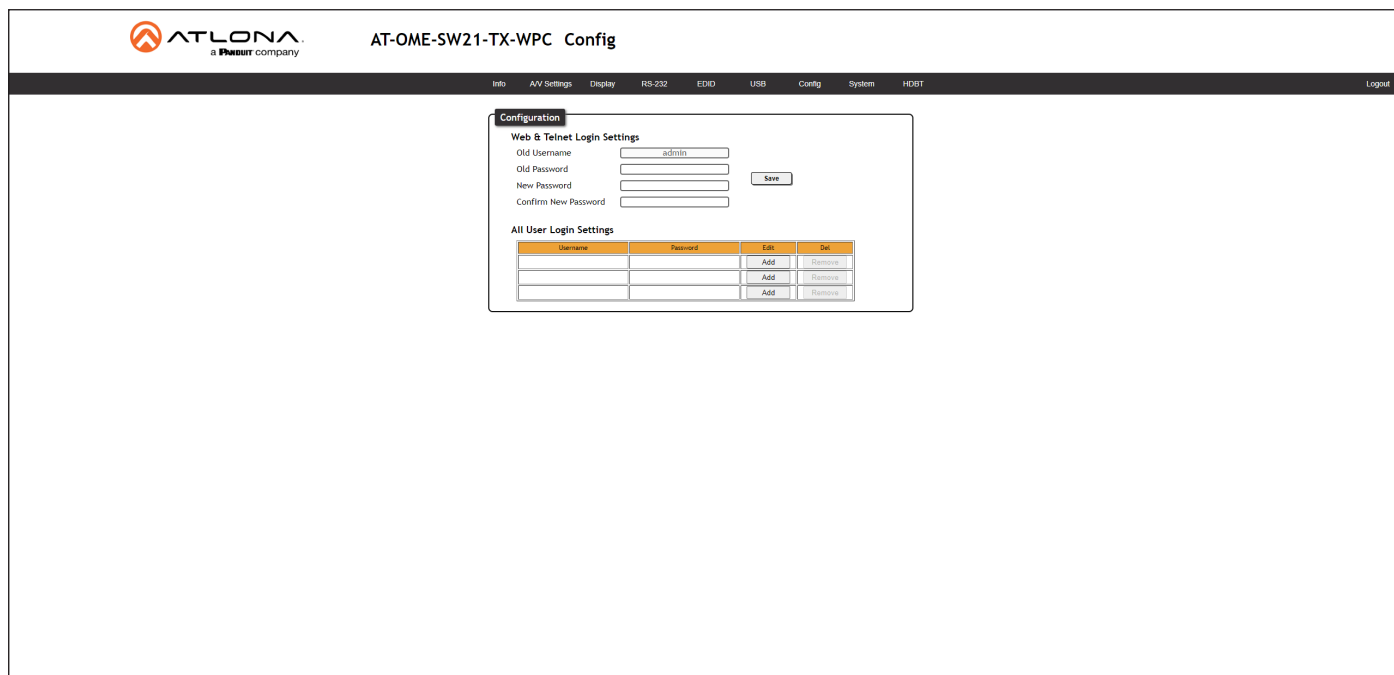

Configuration

Old Username

This field cannot be changed. “admin” is the administrator user.

Old Password

Enter the current password for the “admin” username in this field.

New Username

This field cannot be changed.

Save

Click this button to save all changes.

New Password

Enter the new password from the “admin” username in this field.

Confirm New Password

Verify the new password by retyping it in this field.

All User Login Settings

Refer to [User Management \(page 27\)](#) for more information on creating, editing, and deleting users.

- **Username**
Displays the username.
- **Password**
Displays the password for the associated username.
- **Edit**
Click the **Add** button, in this column, to add a user to the AT-OME-SW21-TX-WPC.
- **Del**
Click the **Remove** button to delete the user in the row. This button will only be available if both a username and password have been created.

System Page

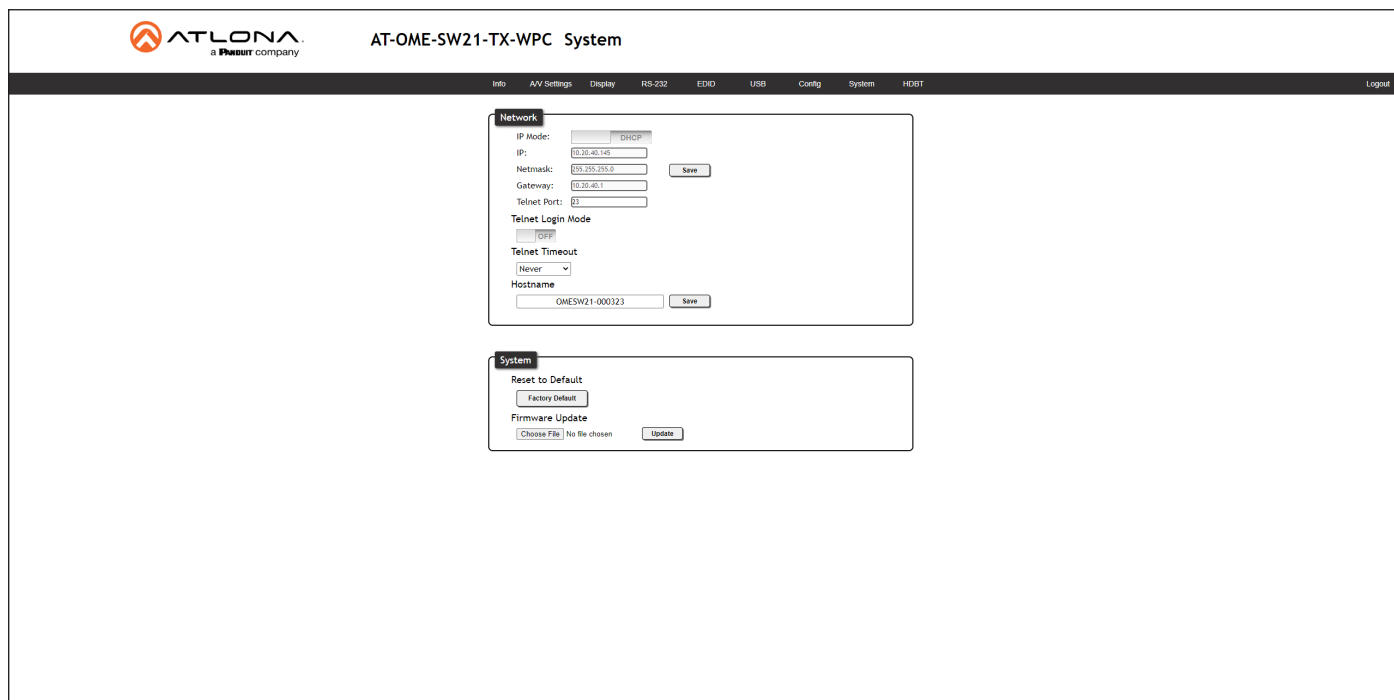

The screenshot displays the configuration interface for the AT-OME-SW21-TX-WPC system. The 'Network' section includes a toggle for IP Mode (currently set to DHCP), input fields for IP (192.168.1.254), Netmask (255.255.255.0), Gateway (192.168.1), and Telnet Port (23). Below these are options for Telnet Login Mode (OFF) and Telnet Timeout (Never). The Hostname field is set to OME-SW21-000323. The 'System' section contains buttons for 'Reset to Default', 'Factory Default', and 'Firmware Update' (with a 'Choose File' button and an 'Update' button).

Network

IP Mode

Click this toggle switch to set the IP mode of the AT-OME-SW21-TX-WPC. The default setting is **DHCP**. Available settings: **STATIC IP**, **DHCP**.

IP

Enter the IP address of the AT-OME-SW21-TX-WPC in this field. This field will only be available if **IP Mode** is set to **STATIC IP**. The default IP address is 192.168.1.254.

Netmask

Enter the subnet mask in this field. This field will only be available if **IP Mode** is set to **STATIC IP**.

Gateway

Enter the gateway (router) address in this field. This field will only be available if **IP Mode** is set to **STATIC IP**.

Telnet Port

Enter the Telnet listening port in this field.

Telnet Login Mode

Click this toggle to set the login mode to either **ON** or **OFF**. If this feature is set to **ON**, then the AT-OME-SW21-TX-WPC will prompt for both the username and password at the start of a Telnet session. Use the same credentials as the web server.

Telnet Timeout

Click this drop-down list to select the timeout interval, in seconds, before the Telnet connection is automatically closed after no activity. Range: 1 to 3600 (seconds).

Hostname

Displays the hostname of the AT-OME-SW21-TX-WPC, as it would appear on a network. To change the hostname, type the new hostname in this field and click the **Save** button.

System

Reset to Default

Click the **Factory Default** button to set the AT-OME-SW21-TX-WPC to factory-default settings.

Firmware Update

Click the **Choose File** button to select the firmware file, when upgrading the firmware on the AT-OME-SW21-TX-WPC. Once the firmware file is selected, click the Update button. Refer to [Updating the Firmware \(page 49\)](#) for more information.

HDBT Page

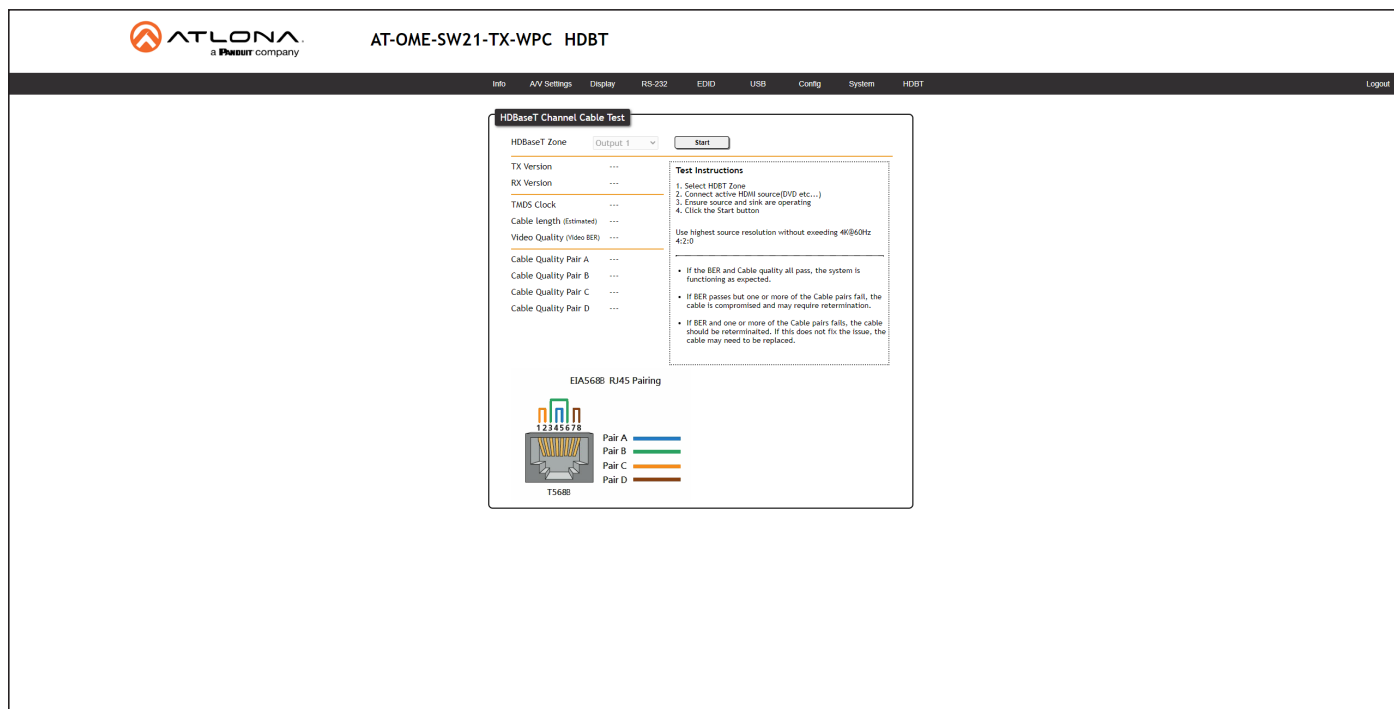

HDBaseT Zone

The AT-OME-SW21-TX-WPC has only a single HDBaseT output. Therefore, this drop-down list is disabled.

Start

Click the **Start** button to begin the HDBaseT testing process. During testing, the button text will change to “Stop”. Click the **Stop** button to halt the HDBaseT testing process. HDBaseT testing can be performed at any time, while the unit is powered. Refer to the instructions on this web page for information on how to interpret the Bit Error Rate (BER) and cable test results.

TX Version

The version of the Valens chip on the transmitter.

RX Version

The version of the Valens chip on the receiver.

TMDS Clock

Displays the pixel clock speed. If no source is connected, then this field will display as “None”.

Cable length (Estimated)

This field indicates the approximate length of the Ethernet cable connected between the HDBaseT port on the AT-OPUS-RX41 and the receiver. If the cable length is less than 15 feet, then this value will be displayed as 0 (zero).

Video Quality (Video BER)

The Bit Error Rate (BER). This field displays either PASS or FAIL during a test.

Cable Quality Pair (A, B, C, D)

Each of these fields will display either PASS or FAIL during a test.

Updating the Firmware

Updating the firmware can be completed using either the USB interface or the built-in web server. Atlona recommends using the web server for updating the firmware. However, if a network connection is not available, the AT-OME-SW21-TX-WPC firmware can be updated using a USB-A to USB micro-B cable.

Using the Web Server

Requirements:

- AT-OME-SW21-TX-WPC
 - Firmware file
 - Computer running Windows
 - USB-A to micro-USB cable
1. Connect an Ethernet cable from the computer, containing the firmware, to the same network where the AT-OME-SW21-TX-WPC is connected.
 2. Go to the [System Page \(page 46\)](#) in the web server.

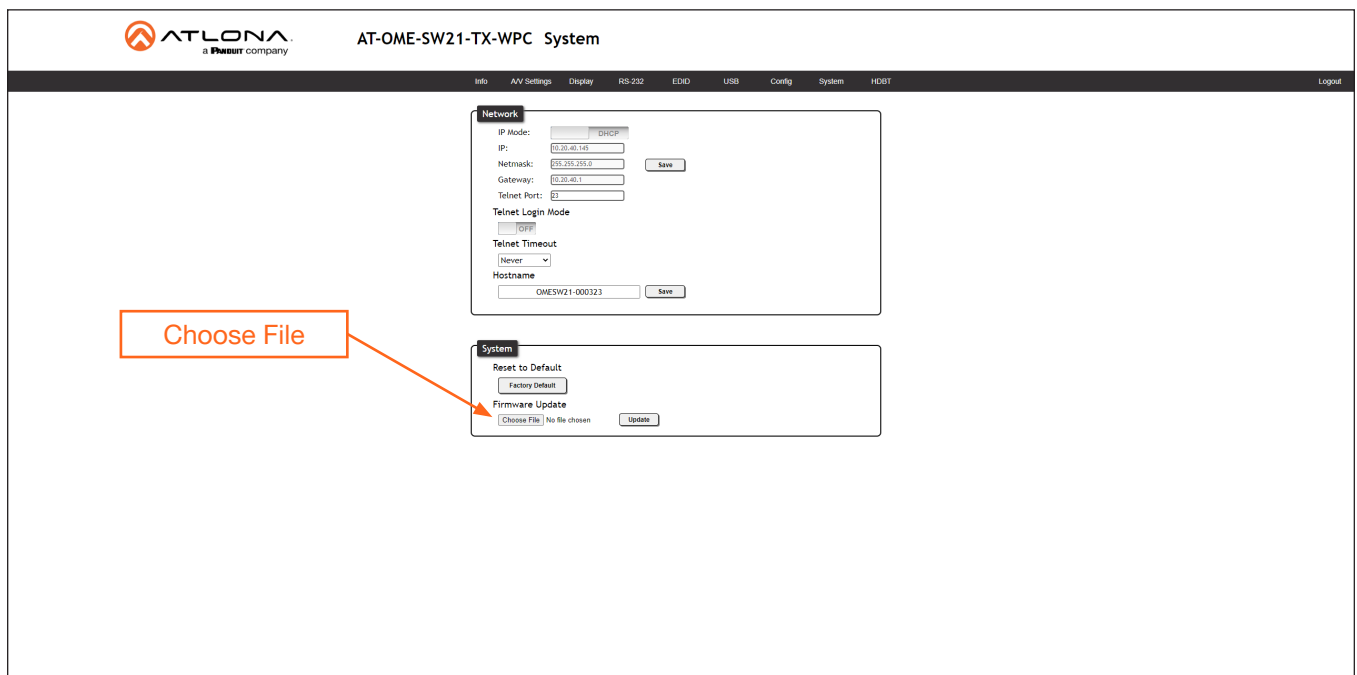

3. Click the **Choose File** button, under the **Firmware Update** section.
4. Browse to the location of the firmware file, select it, and click the **Open** button.
5. Click the **Update** button, under the **Firmware Update** section.

6. The following message box will be displayed.

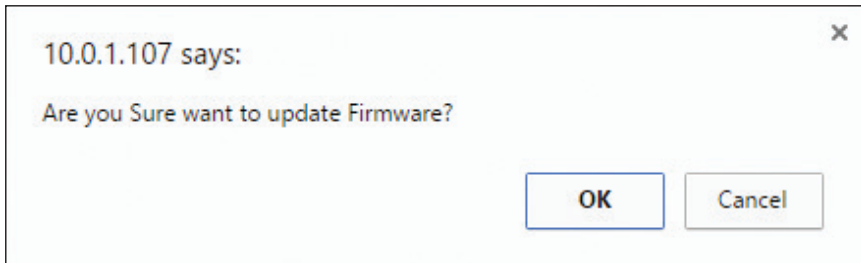

7. Click the **OK** button to begin the firmware update process. Click the **Cancel** button to cancel the process.
8. After the firmware update process is complete, the **Login** screen will be displayed.

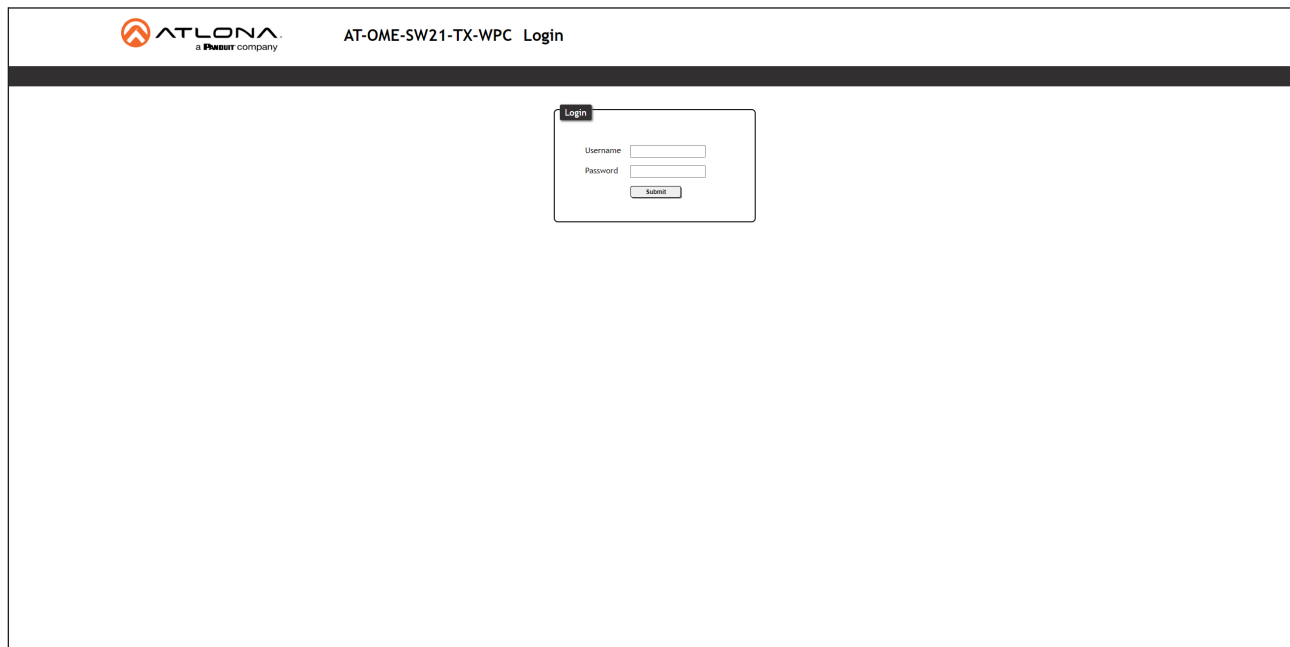

Using USB

Requirements:

- AT-OME-SW21-TX-WPC
- Firmware file
- Computer running Windows
- USB-A to micro-USB cable

1. Disconnect power from the AT-OME-SW21-TX-WPC, which can be done by disconnecting the category cable from the HDBaseT port on the receiver.
2. Remove the faceplate to access the hidden “firmware update” button, located above the PWR LED indicator. Refer to [Faceplate Removal and Assembly \(page 12\)](#) for more information.

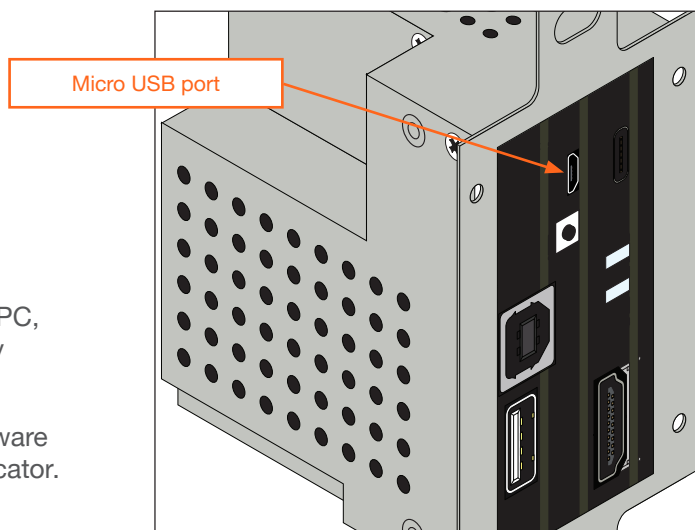

4. Connect a USB cable from the micro USB port on the AT-OME-SW21-TX-WPC to a PC, using a USB-A to micro-USB cable.
5. Power the AT-OME-SW21-TX-WPC by reconnecting the HDBaseT cable on the receiver.
4. The USB UPDATE folder will be displayed. If this folder is not displayed, automatically, select the USB UPDATE drive from Windows Explorer. Refer to the next page for an illustration.

If this folder is not displayed, automatically, select the USB UPDATE drive from Windows Explorer.

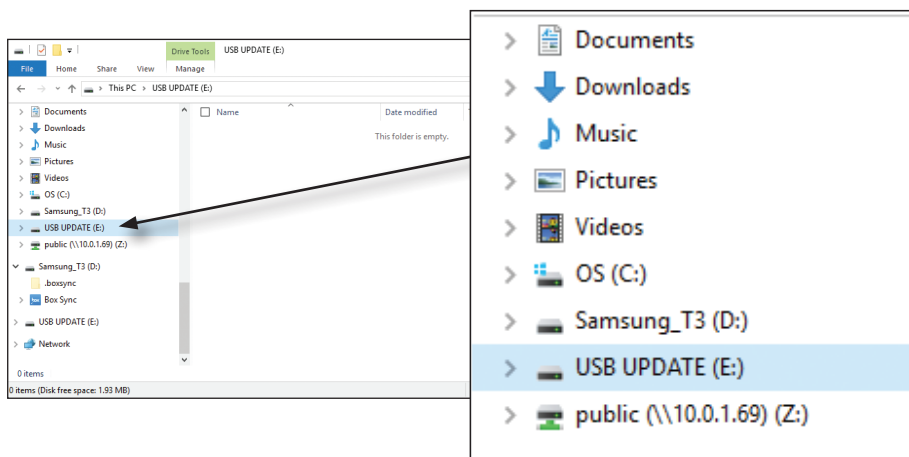

5. Delete all files from the USB UPDATE drive, if any are present.
6. Drag-and-drop the firmware file to the drive.
7. After the file has been copied, disconnect the USB cable from both the computer and the AT-OME-SW21-TX-WPC.
8. The firmware update process is complete.
9. Reconnect the Ethernet cable to the **HDBaseT OUT** port.

Specifications

Video	
Signal Type	Input - DisplayPort Alternate Mode (USB-C), HDMI Output - HDBaseT
Copy Protection	HDCP 1.4/2.2
Pixel Clock	300MHz
UHD/HD/SD	4096×2160(DCI)@60/50/30 ⁽¹⁾ /25/24 Hz 1920×1080i@30/29.97/25 Hz 3840×2160(UHD)@60/50/30 ⁽¹⁾ /25/24 Hz 1280×720p@60/59.94/50/30 Hz 2560×1440@30 Hz 720×576i/p@50 Hz 1920×1080p@60/59.94/50/30/29.97/25 720×480i/p@60 Hz /24/23.98 Hz
VESA All resolutions are 60Hz	2560×1600 1280×800 1920×1200 1366×768 1680×1050 1360×768 1600×1200 1152×864 1440×900 1024×768 1400×1050 800×600 1280×1024 640×480
Color Space	YUV, RGB
Chroma Subsampling	4:4:4, 4:2:0 ⁽¹⁾
Color Depth	8-bit, 10-bit, 12-bit

Audio			
Pass-through	PCM 2.0 LPCM 5.1 LPCM 7.1	Dolby® Digital Dolby Digital Plus™ Dolby TrueHD Dolby Atmos®	DTS® Digital Surround™ DTS-HD Master Audio™ DTS:X®
Bit Rate	24 Mbits/s max		
Sample Rate	32 kHz, 44.1 kHz, 48 kHz, 88.2 kHz, 96 kHz, 176.4 kHz, 192 kHz		

USB	
Signal	2.0
Maximum Data Rate	120 Mbps

Connectors	
USB-C	1 - USB Type-C v3.1, 24-pin female
HDMI	1 - Type A, 19-pin female
HDBaseT OUT	1 - RJ45
HOST	1 - USB Type-B, female
DEVICE	1 - USB Type-A, female

Indicators and Controls	
PWR indicator	1 - LED, green
LINK indicator	1 - LED, yellow

Resolution / Distance	4K/UHD - Feet / Meters		1080p - Feet / Meters	
USB-C	6	2	6	2
CAT5e	295	90	330	100
CAT6/6a/7	330	100	330	100

Power	
Consumption	12.5 W
Supply	PoE via connected receiver

Temperature	Fahrenheit	Celsius
Operating	+32 to +104	0 to +40
Storage	-4 to +140	-20 to +60
Humidity (RH)	20% to 90%, non-condensing	

Dimensions (H x W x D)	Inches	Millimeters
Unit	4.06 x 1.78 x 2.64	103 x 45 x 67

Weight	Pounds	Kilograms
Device	0.74	0.34

Certification	
Device	CE, FCC

Footnotes

- (1) HDMI input supports up to 4K/UHD @ 60 Hz YUV 4:4:4 8-bit. HDBaseT output supports 4K/UHD @ 60 Hz YUV 4:2:0 only. USB-C limited to 4096x2160 @ 30 Hz & 3840x2160 @ 30 Hz 4:4:4 8-bit only.

