

# Three-Input HD Video Scaler for HDMI and VGA Signals



## Version Information

---

Version	Release Date	Notes
6	Mar 2017	New manual format
7	May 2017	Added DispBtn command (only available when running firmware v1.3.30)
8	Oct 2019	Updated for firmware 1.4.09; added hostname support and help balloons within web GUI.

## Welcome to Atlona!

---

Thank you for purchasing this Atlona product. We hope you enjoy it and will take a extra few moments to register your new purchase.

Registration only takes a few minutes and protects this product against theft or loss. In addition, you will receive notifications of product updates and firmware. Atlona product registration is voluntary and failure to register will not affect the product warranty.

To register your product, go to <http://www.atlona.com/registration>

## Sales, Marketing, and Customer Support

---

### Main Office

Atlona Incorporated  
70 Daggett Drive  
San Jose, CA 95134  
United States

Office: +1.877.536.3976 (US Toll-free)  
Office: +1.408.962.0515 (US/International)

Sales and Customer Service Hours  
Monday - Friday: 6:00 a.m. - 4:30 p.m. (PST)

<http://www.atlona.com/>

### International Headquarters

Atlona International AG  
Ringstrasse 15a  
8600 Dübendorf  
Switzerland

Office: +41 43 508 4321

Sales and Customer Service Hours  
Monday - Friday: 09:00 - 17:00 (UTC +1)

## Operating Notes

---



**IMPORTANT:** Visit <http://www.atlona.com/product/AT-HD-SC-500> for the latest firmware updates and User Manual.

- The Atlona Management System (AMS) is a free downloadable application from Atlona that provides network configuration assistance for this product. This application is available only for the Windows® Operating System and can be downloaded from the Atlona web site.
- Consumer Electronics Control (CEC): Atlona has confirmed proper CEC functionality with several current models of Samsung, Panasonic, and Sony displays. However, it is not guaranteed that CEC will work with all displays. Many manufacturers do not support the CEC “off” command, and older displays use proprietary commands. Atlona only supports displays that use the CEC command structure defined in HDMI 1.2a. It is recommended that dealers request an evaluation product from Atlona, before designing a system using the CEC protocol. If this is not possible, then other control methods will need to be considered, in order to control displays using Atlona products.

# Atlona, Inc. (“Atlona”) Limited Product Warranty

---

## Coverage

Atlona warrants its products will substantially perform to their published specifications and will be free from defects in materials and workmanship under normal use, conditions and service.

Under its Limited Product Warranty, Atlona, at its sole discretion, will either:

- repair or facilitate the repair of defective products within a reasonable period of time, restore products to their proper operating condition and return defective products free of any charge for necessary parts, labor and shipping.

OR

- replace and return, free of charge, any defective products with direct replacement or with similar products deemed by Atlona to perform substantially the same function as the original products.

OR

- refund the pro-rated value based on the remaining term of the warranty period, not to exceed MSRP, in cases where products are beyond repair and/or no direct or substantially similar replacement products exist.

Repair, replacement or refund of Atlona products is the purchaser’s exclusive remedy and Atlona liability does not extend to any other damages, incidental, consequential or otherwise.

This Limited Product Warranty extends to the original end-user purchaser of Atlona products and is non-transferrable to any subsequent purchaser(s) or owner(s) of these products.

## Coverage Periods

Atlona Limited Product Warranty Period begins on the date of purchase by the end-purchaser. The date contained on the end-purchaser’s sales or delivery receipt is the proof purchase date.

### Limited Product Warranty Terms – New Products

- 10 years from proof of purchase date for hardware/electronics products purchased on or after June 1, 2013.
- 3 years from proof of purchase date for hardware/electronics products purchased before June 1, 2013.
- Lifetime Limited Product Warranty for all cable products.

### Limited Product Warranty Terms – Refurbished (B-Stock) Products and Discontinued Products

- 3 years from proof of purchase date for all Refurbished (B-Stock) and Discontinued hardware and electronic products purchased on or after June 1, 2013.

## Remedy

Atlona recommends that end-purchasers contact their authorized Atlona dealer or reseller from whom they purchased their products. Atlona can also be contacted directly. Visit [atlona.com](http://atlona.com) for Atlona’s contact information and hours of operation. Atlona requires that a dated sales or delivery receipt from an authorized dealer, reseller or end-purchaser is provided before Atlona extends its warranty services. Additionally, a return merchandise authorization (RMA) and/or case number, is required to be obtained from Atlona in advance of returns.

Atlona requires that products returned are properly packed, preferably in the original carton, for shipping. Cartons not bearing a return authorization or case number will be refused. Atlona, at its sole discretion, reserves the right to reject any products received without advanced authorization. Authorizations can be requested by calling 1-877-536-3976 (US toll free) or 1-408- 962-0515 (US/international) or via Atlona’s website at [atlona.com](http://atlona.com).

## Exclusions

This Limited Product Warranty excludes:

- Damage, deterioration or malfunction caused by any alteration, modification, improper use, neglect, improper packaging or shipping (such claims must be presented to the carrier), lightning, power surges, or other acts of nature.

- Damage, deterioration or malfunction resulting from the installation or removal of this product from any installation, any unauthorized tampering with this product, any repairs attempted by anyone unauthorized by Atlona to make such repairs, or any other cause which does not relate directly to a defect in materials and/or workmanship of this product.
- Equipment enclosures, cables, power supplies, batteries, LCD displays, and any accessories used in conjunction with the product(s).
- Products purchased from unauthorized distributors, dealers, resellers, auction websites and similar unauthorized channels of distribution.

#### Disclaimers

This Limited Product Warranty does not imply that the electronic components contained within Atlona's products will not become obsolete nor does it imply Atlona products or their electronic components will remain compatible with any other current product, technology or any future products or technologies in which Atlona's products may be used in conjunction with. Atlona, at its sole discretion, reserves the right not to extend its warranty offering in instances arising outside its normal course of business including, but not limited to, damage inflicted to its products from acts of god.

#### Limitation on Liability

The maximum liability of Atlona under this limited product warranty shall not exceed the original Atlona MSRP for its products. To the maximum extent permitted by law, Atlona is not responsible for the direct, special, incidental or consequential damages resulting from any breach of warranty or condition, or under any other legal theory. Some countries, districts or states do not allow the exclusion or limitation of relief, special, incidental, consequential or indirect damages, or the limitation of liability to specified amounts, so the above limitations or exclusions may not apply to you.

#### Exclusive Remedy

To the maximum extent permitted by law, this limited product warranty and the remedies set forth above are exclusive and in lieu of all other warranties, remedies and conditions, whether oral or written, express or implied. To the maximum extent permitted by law, Atlona specifically disclaims all implied warranties, including, without limitation, warranties of merchantability and fitness for a particular purpose. If Atlona cannot lawfully disclaim or exclude implied warranties under applicable law, then all implied warranties covering its products including warranties of merchantability and fitness for a particular purpose, shall provide to its products under applicable law. If any product to which this limited warranty applies is a "Consumer Product" under the Magnuson-Moss Warranty Act (15 U.S.C.A. §2301, ET SEQ.) or other applicable law, the foregoing disclaimer of implied warranties shall not apply, and all implied warranties on its products, including warranties of merchantability and fitness for the particular purpose, shall apply as provided under applicable law.

#### Other Conditions

Atlona's Limited Product Warranty offering gives legal rights, and other rights may apply and vary from country to country or state to state. This limited warranty is void if (i) the label bearing the serial number of products have been removed or defaced, (ii) products are not purchased from an authorized Atlona dealer or reseller. A comprehensive list of Atlona's authorized distributors, dealers and resellers can be found at [www.atlona.com](http://www.atlona.com).

## Important Safety Information



CAUTION: TO REDUCE THE RISK OF ELECTRIC SHOCK DO NOT OPEN ENCLOSURE OR EXPOSE TO RAIN OR MOISTURE. NO USER-SERVICEABLE PARTS INSIDE REFER SERVICING TO QUALIFIED SERVICE PERSONNEL.



The exclamation point within an equilateral triangle is intended to alert the user to the presence of important operating and maintenance instructions in the literature accompanying the product.



The information bubble is intended to alert the user to helpful or optional operational instructions in the literature accompanying the product.

1. Read these instructions.
2. Keep these instructions.
3. Heed all warnings.
4. Follow all instructions.
5. Do not use this product near water.
6. Clean only with a dry cloth.
7. Do not block any ventilation openings. Install in accordance with the manufacturer's instructions.
8. Do not install or place this product near any heat sources such as radiators, heat registers, stoves, or other apparatus (including amplifiers) that produce heat.
9. Do not defeat the safety purpose of a polarized or grounding-type plug. A polarized plug has two blades with one wider than the other. A grounding type plug has two blades and a third grounding prong. The wide blade or the third prong are provided for your safety. If the provided plug does not fit into your outlet, consult an electrician for replacement of the obsolete outlet.
10. Protect the power cord from being walked on or pinched particularly at plugs, convenience receptacles, and the point where they exit from the product.
11. Only use attachments/accessories specified by Atlona.
12. To reduce the risk of electric shock and/or damage to this product, never handle or touch this unit or power cord if your hands are wet or damp. Do not expose this product to rain or moisture.
13. Unplug this product during lightning storms or when unused for long periods of time.
14. Refer all servicing to qualified service personnel. Servicing is required when the product has been damaged in any way, such as power-supply cord or plug is damaged, liquid has been spilled or objects have fallen into the product, the product has been exposed to rain or moisture, does not operate normally, or has been dropped.



## FCC Statement

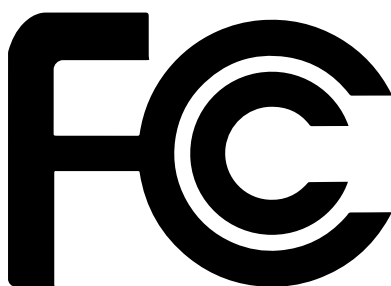

FCC Compliance and Advisory Statement: This hardware device complies with Part 15 of the FCC rules. Operation is subject to the following two conditions: 1) this device may not cause harmful interference, and 2) this device must accept any interference received including interference that may cause undesired operation. This equipment has been tested and found to comply with the limits for a Class A digital device, pursuant to Part 15 of the FCC Rules. These limits are designed to provide reasonable protection against harmful interference in a commercial installation.

This equipment generates, uses, and can radiate radio frequency energy and, if not installed or used in accordance with the instructions, may cause harmful interference to radio communications. However there is no guarantee that interference will not occur in a particular installation. If this equipment does cause harmful interference to radio or television reception, which can be determined by turning the equipment off and on, the user is encouraged to try to correct the interference by one or more of the following measures: 1) reorient or relocate the receiving antenna; 2) increase the separation between the equipment and the receiver; 3) connect the equipment to an outlet on a circuit different from that to which the receiver is connected; 4) consult the dealer or an experienced radio/TV technician for help. Any changes or modifications not expressly approved by the party responsible for compliance could void the user's authority to operate the equipment. Where shielded interface cables have been provided with the product or specified additional components or accessories elsewhere defined to be used with the installation of the product, they must be used in order to ensure compliance with FCC regulations.

# Table of Contents

---

<b>Introduction</b>	<b>9</b>
<b>Features</b>	<b>9</b>
<b>Package Contents</b>	<b>9</b>
<b>Panel Description</b>	<b>10</b>
<b>Installation</b>	<b>11</b>
RS-232	11
Power	11
Audio	12
Connection Instructions	12
Connection Diagram	13
IP Configuration	14
Using the Front Panel	14
Using Commands	14
Using the Web GUI	15
<b>Device Operation</b>	<b>16</b>
Selecting the Input	16
Passing Analog Audio	17
<b>Configuration and Management Interfaces</b>	<b>18</b>
The On-Screen Display (OSD)	18
Input Select	19
Input Resolution	19
Output Resolution	20
Picture Adjust	20
Aspect	21
Overscan	22
Audio	22
OSD	24
Control Settings	25
Others	27
Information	29
The Web GUI	30
Video Page	34
Audio Page	36
Picture Page	37
EDID Page	38
Display Page	39
RS-232 Page	41
OSD Page	42
Config Page	43
Network Page	44
<b>Solution Setup and Configuration Guide</b>	<b>46</b>
Input Auto Switching	46
Using the OSD	46
Using the Web GUI	48
Display Control	50
Using RS-232	50
Using IP	53

<b>Appendix</b>	<b>55</b>
Updating the Firmware	55
Using the Web GUI	55
Using USB	56
Mounting Instructions	58
Default Settings	59
Specifications	61
<b>Index</b>	<b>62</b>



## Introduction

---

The dual HDMI and VGA switcher w/scaler provides a multisystem solution. Use the HD-SC-500 as: a standalone 3 in 1 out switcher for small systems, an analog to digital video converter for systems with no VGA ports, and a scaler for systems with displays that require specific resolutions. Supports scaling of video up to 1920x1200/1080p, VGA conversion and audio embedding and de-embedding, the HD-SC-500 has a function in almost any system.

## Features

---

- Scales incoming signals up to 1920x1200
- Three input, one output switcher
- Auto-switching (activated through RS-232 or webGUI)
- HDMI inputs support DVI and DisplayPort signals (with adaptors)
- Audio input for embedding audio onto video signals
- Control of brightness, contrast, saturation, hue, and sharpness
- Volume control
- Adjust treble and bass of audio output to ensure the best speaker performance
- Balanced, analog audio output for de-embedding audio to amplifiers or audio systems
- Control via RS-232, TCP/IP, webGUI, and OSD
- Ability to switch HDCP reporting between compliant and non-compliant
- Firmware upgradable for easy field service through USB or web GUI

## Package Contents

---

- 1 x AT-HD-SC-500
- 1 x Phoenix terminal block, 5-pin (captive screw)
- 1 x Phoenix terminal block, 3-pin (captive screw)
- 1 x Phoenix terminal block, 2-pin (captive screw)
- 1 x 5V DC power supply
- 1 x Wall/table mount ears
- 1 x Installation Guide

## Panel Description

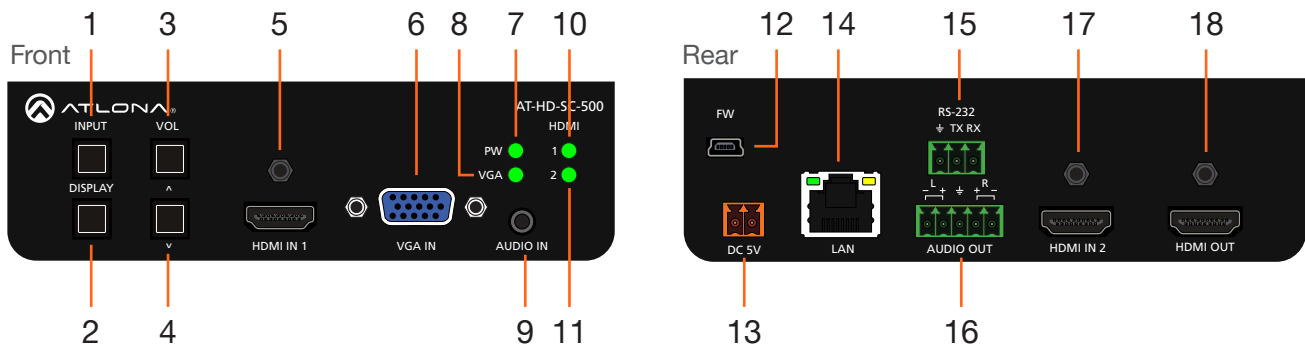

### 1 INPUT

Press this button to select the desired input.

### 2 DISPLAY

Press this button to show the On-Screen Display (OSD) and select items within the OSD.

### 3 VOL / UP CURSOR

Press this button to adjust the volume on the connected display and to select items within the OSD.

### 4 DOWN CURSOR

Press this button to scroll down within the OSD.

### 5 HDMI IN 1

Connect an HDMI cable from this port to an HD source.

### 6 VGA IN

Connect a VGA cable from this port to a VGA source.

### 7 PW

This LED indicator will glow bright green when the switcher is powered.

### 8 VGA

This LED indicator will glow bright green when the VGA IN port is selected.

### 9 AUDIO IN

Connect a 3.5mm mini-stereo audio cable, from an analog audio source, to this port.

### 10 HDMI 1

This LED indicator will glow bright green when the HDMI 1 port is selected.

### 11 HDMI 2

This LED indicator will glow bright green when the HDMI 2 port is selected.

### 12 FW

Connect a mini USB to USB-A type cable from this port to a computer to update the firmware. See [Updating the Firmware \(page 55\)](#) for more information.

### 13 DC 5V

Connect the included 2-pin Phoenix block from this connector to the 5V DC power supply.

### 14 LAN

Connect an Ethernet cable from this port to a Local Area Network (LAN).

### 15 RS-232

Connect the included 3-pin Phoenix block from this connector to an RS-232 device.

### 16 AUDIO OUT

Connect the included 5-pin Phoenix block from this connector to an audio amplifier.

### 17 HDMI IN 2

Connect an HD source to this port.

### 18 HDMI OUT

Connect an HDMI cable from this port to a display (sink) device.

# Installation

## RS-232

The AT-HD-SC-500 provides RS-232 control between an automation system and an RS-232 device. This step is optional.

1. Use wire strippers to remove a portion of the cable jacket.
2. Remove at least 3/16" (5 mm) from the insulation of the RX, TX, and GND wires.
3. Insert the TX, RX, and GND wires into correct terminal on the included Phoenix block. If using non-tinned stranded wire, press the orange tab, above the terminal, while inserting the exposed wire. Repeat this step for the TX, RX, and GND connections.

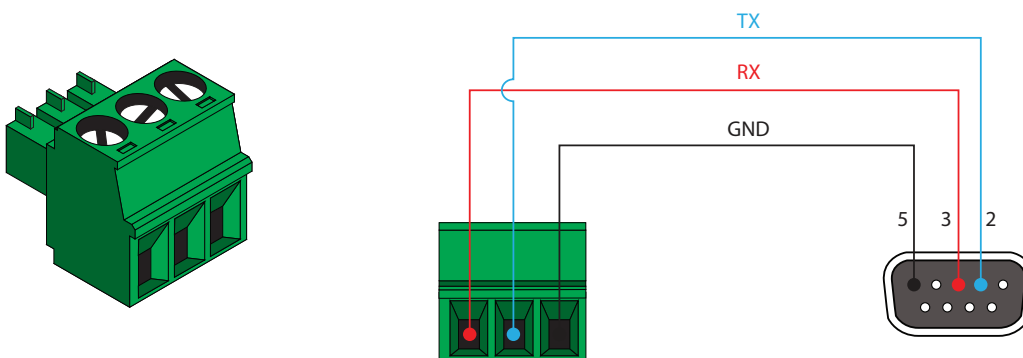

## Power

Locate the included orange Phoenix terminal block and wire the included power supply to the block, as shown below. Do not use high-torque devices, when securing the wires to the Phoenix terminal block, as this may damage the screws and/or block.

1. Insert the wires into the correct terminal on the included Phoenix block, as shown below.
2. Tighten the screws to secure the wires. Do not use high-torque devices as this may damage the screws and/or connector block.

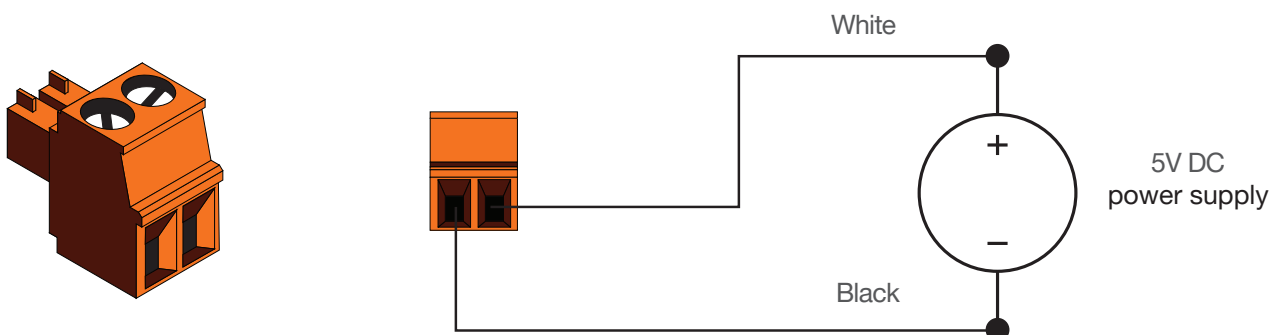

## Audio

The **AUDIO OUT** connector on the AT-HD-SC-500 provides the connection of either balanced or unbalanced audio outputs using XLR connectors. Use the included 5-pin Phoenix terminal block.

Balanced audio connections use two signal wires and a ground to minimize interference in audio signals. Unbalanced audio connections use one signal wire and a ground and are used if system components don't support balanced signals.

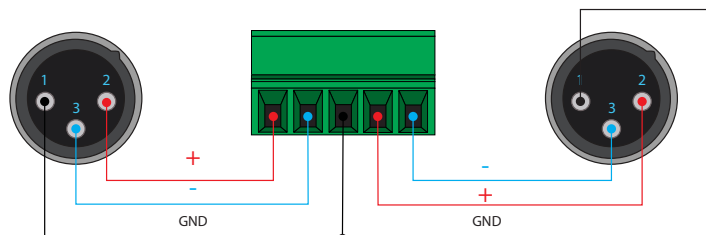
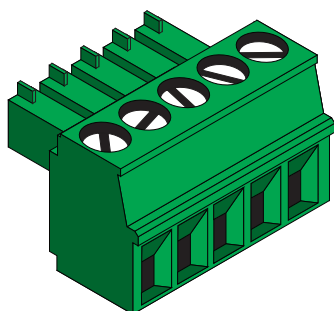

Balanced

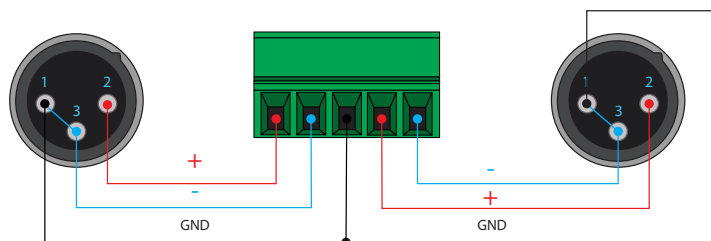

Unbalanced

## Connection Instructions

1. Connect an HDMI cable between the HD source and the **HDMI IN 1** port on the switcher.
2. Connect another HDMI cable between another HD source and the **HDMI IN 2** port on the switcher.
3. Connect a VGA cable from a VGA source to the **VGA IN** port on the switcher.
4. Connect a 3.5 mm mini-stereo cable from the **AUDIO IN** port on the switcher to the analog audio source. This port allows two-channel analog audio to be included when the **VGA IN** port is selected. See [Passing Analog Audio \(page 17\)](#) for more information.
5. Connect an Ethernet cable, up to 330 feet (100 meters), from the **LAN** port on the switcher to a Local Area Network (LAN).



**IMPORTANT:** If EZ RJ-45 connectors are being used to terminate Ethernet cable, make sure that each twisted pair does not extend beyond the RJ-45 connector. Exposed twisted-pair wires may cause a short when connected to the **LAN** port.

6. Connect an HDMI cable from the **HDMI OUT** port on the switcher to an HD display.
7. OPTIONAL: Connect an RS-232 device, such as a projector, to the **RS-232** port on the switcher.
8. OPTIONAL: Connect an audio amplifier, or other audio output device, to the **AUDIO OUT** port on the switcher.
9. Connect the included 5V DC power supply to the **DC 5V** port.
10. Connect the power supply to an available AC outlet.

### Connection Diagram

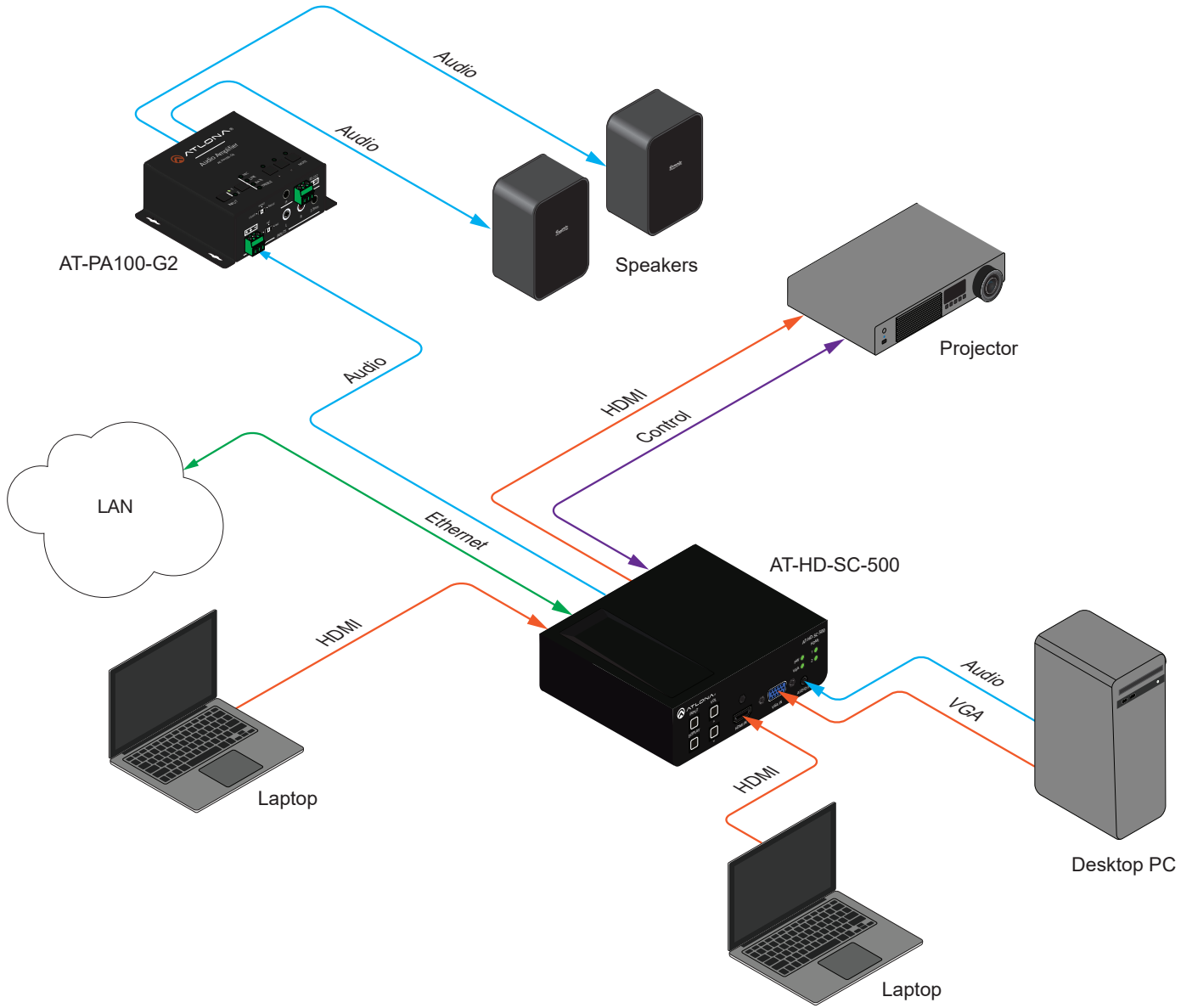

## IP Configuration

The AT-HD-SC-500 is shipped with DHCP enabled. Once connected to a network, the DHCP server (if available), will automatically assign an IP address to the unit. Use an IP scanner, along with the MAC address on the bottom of the unit, to identify both the unit and its IP address on the network. If a static IP address is desired, the unit can be switched to static IP mode. Use one of the following procedures to switch between DHCP and static IP mode. The default static IP address of the AT-HD-SC-500 is 192.168.1.254.

### Using the Front Panel

1. Make sure the AT-HD-SC-500 is powered.
2. Press and hold the **INPUT** button for approximately 15 seconds.



DISPLAY button

3. Release the **INPUT** button once the **DISPLAY** button begins to flash. The number of flashes will indicate the currently selected IP mode.

PW LED flashes	Description
Two	Static IP mode
Four	DHCP mode

### Using Commands

Use the **IPStatic** and **IPDHCP** commands to switch between DHCP and IP mode through RS-232 or Telnet. Refer to Application Programmers Interface (API) on the Atlona web site for more information. All commands and their arguments are case-sensitive.

- **Setting static IP mode**

1. Connect to the AT-HD-SC-500 using RS-232 or Telnet.
2. At the command line, execute the **IPDHCP** command using the off argument, as shown.

```
IPDHCP off
```

3. Execute the **IPStatic** command. This command requires three arguments: the desired IP address of the AT-HD-SC-500, the subnet mask, and the gateway address. All arguments must be entered in dot-decimal notation. The following is an example:

```
IPStatic 192.168.1.112 255.255.255.0 192.168.1.1
```

- **Setting DHCP mode**

1. Connect to the AT-HD-SC-500 using RS-232 or Telnet.
2. At the command line, execute the **IPDHCP** command using the on argument, as shown. All characters are case-sensitive.

```
IPDHCP on
```

Once DHCP is enabled, the unit will be assigned an IP address by the DHCP server (if present).

### Using the Web GUI

The **Network Page** (page 44) in the web GUI, allows the AT-HD-SC-500 to use either DHCP or static IP mode. In order to access the web GUI, the IP address of the AT-HD-SC-500 must be known.

1. Open the desired web browser and enter the IP address of the AT-HD-SC-500.
2. Log in, using the required credentials. The factory-default username and password are listed below:

Username: root  
Password: Atlona

3. Click the **Network** tab.

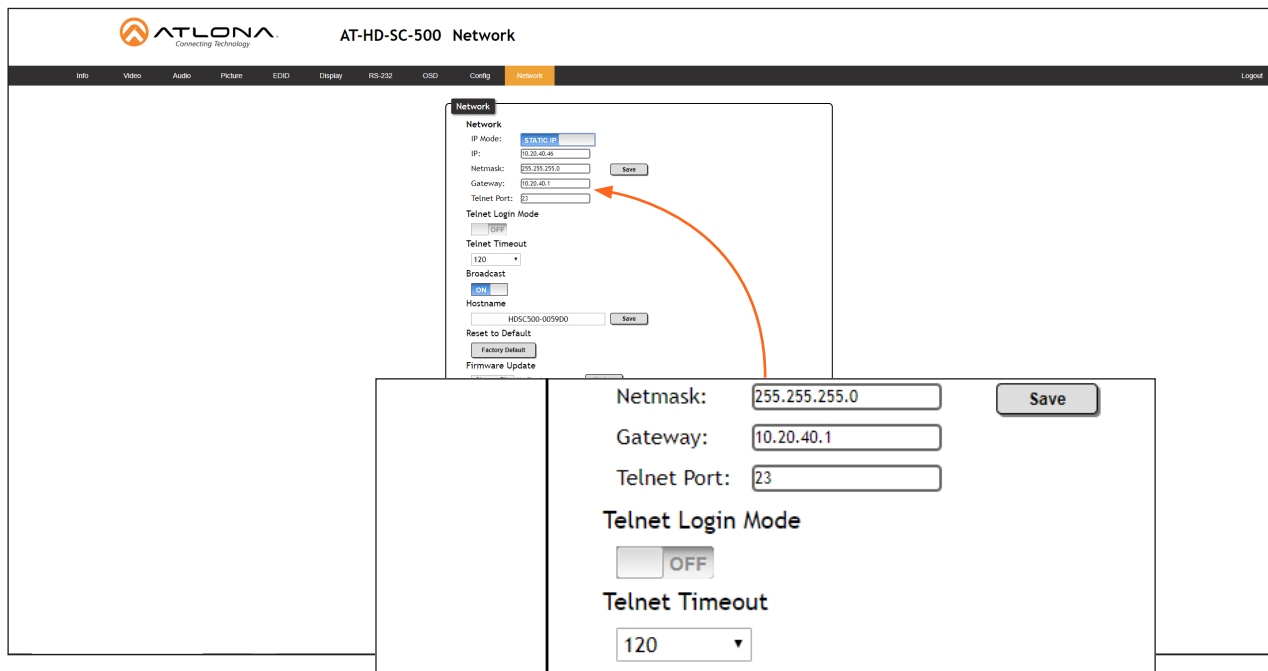

4. Click the **IP Mode** toggle to switch between the **DHCP** and **STATIC IP** setting.  
When set to **STATIC IP**, the **IP**, **Netmask**, and **Gateway** fields can be modified.
5. Click the **Save** button to save the changes.

# Device Operation

## Selecting the Input

Press the **INPUT** button to cycle through each of the available inputs on the unit. The unit will always retain the last selected input when the unit is powered-off.

1. Below, the **HDMI 1** LED indicator is bright green, indicating that **HDMI IN 1** is the active input. This is the default port selection of the AT-HD-SC-500.



2. Press the **INPUT** button, to select **HDMI IN 2**. The **HDMI 2** LED indicator will turn bright green.

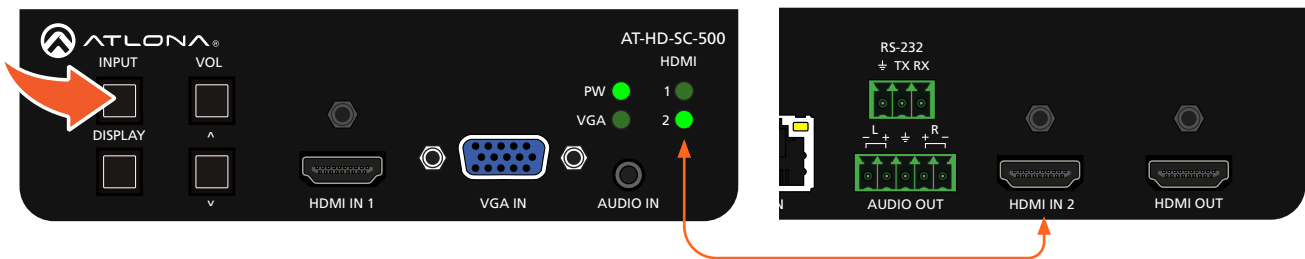

3. Press the **INPUT** button a third time, to select the **VGA IN** port. The **VGA** LED indicator will turn bright green.
4. Press the **INPUT** button again to return to **HDMI IN 1**.



## Passing Analog Audio

The AT-HD-SC-500 can pass two-channel analog audio, by itself, or with a VGA signal. The signal is embedded on the HDMI output.

1. Connect a 3.5 mm mini-stereo cable from the **AUDIO IN** port to the analog audio source.
2. OPTIONAL: Connect a VGA source to the **VGA IN** port.
3. Press the **INPUT** button until the **VGA** indicator turns bright green. This input must be selected in order to use the **AUDIO IN** port.

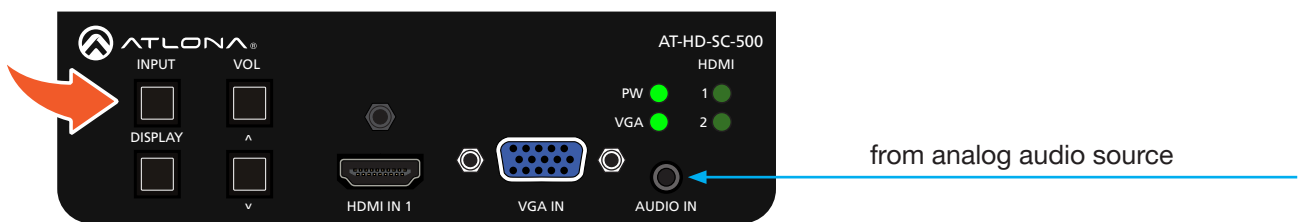

**NOTE:** The analog audio input will not replace existing embedded HDMI audio. Audio is heard only if the HDMI source has no audio. DVI to HDMI adapters can also be used when connecting DVI sources to one of the HDMI inputs, allowing the analog audio to be audible on the output.

The example, below, shows a desktop PC providing both the audio and video source. However, these signals may be connected to separate sources. The dotted line indicates that the video source is optional.

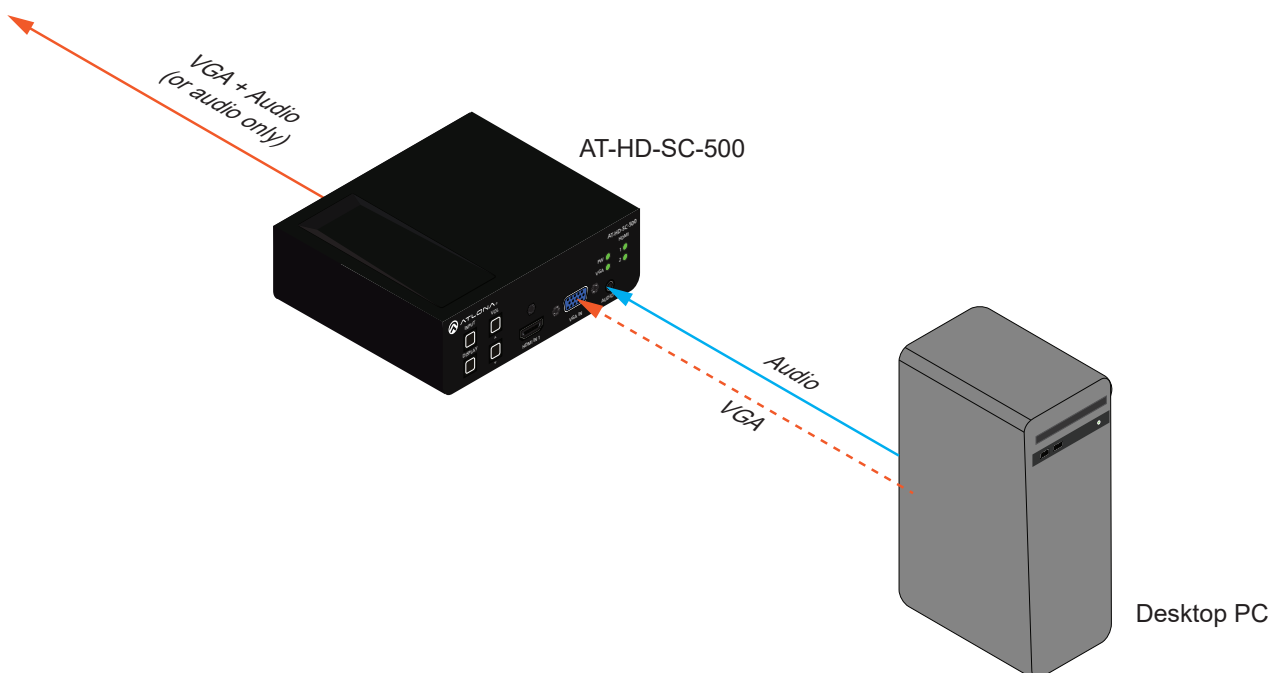

# Configuration and Management Interfaces

## The On-Screen Display (OSD)

The AT-HD-SC-500 includes a built-in OSD menu system to manage and control all video features.

1. Press and hold the **DISPLAY** button, until the OSD is shown.

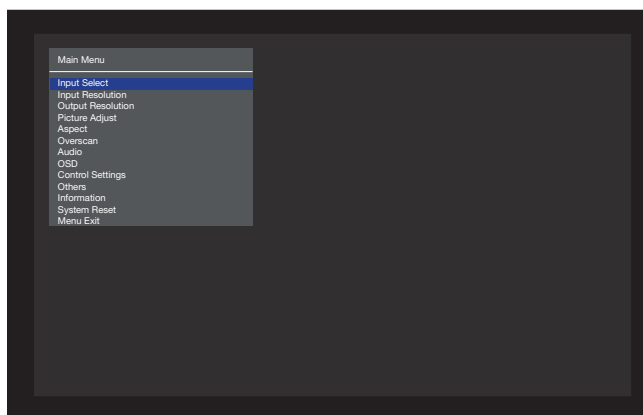

2. Release the **DISPLAY** button.

3. Press the **VOL UP / VOL DN** buttons to highlight the various menu options. The currently selected menu item will be highlighted with a blue cursor bar. Press the **VOL UP** button to move the cursor up through the menu system and press the **VOL DN** button to move down.

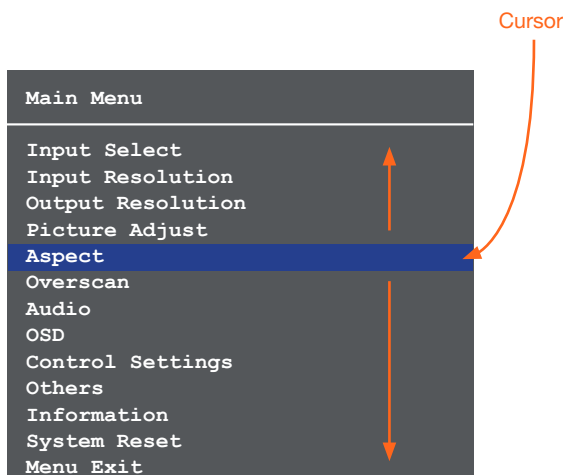
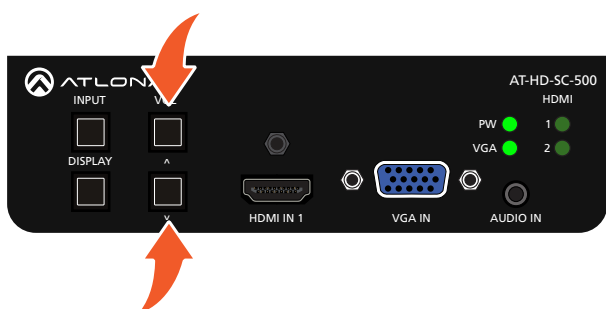

4. Once the desired menu item is highlighted, press the **DISPLAY** button to access its settings.

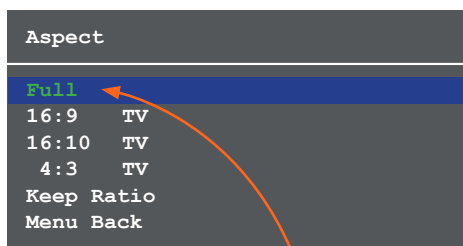
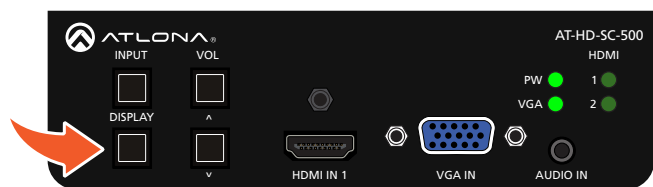

Within the menu item, the current setting will always be highlighted in green.

In this illustration, the Aspect menu item indicates that **Full** is the currently selected aspect ratio setting. Refer to [Aspect \(page 21\)](#) for more information.

### Input Select

Selects the desired input. This can also be done using the INPUT button on the front panel. Refer to [Selecting the Input \(page 16\)](#) for more information.

1. Under the **Main Menu**, highlight the **Input Select** menu item using the **VOL UP/DN** buttons on the front panel.
2. Press the **DISPLAY** button.
3. The **Input Select** menu will be displayed.
4. Press the **VOL UP/DN** buttons to highlight the desired input.

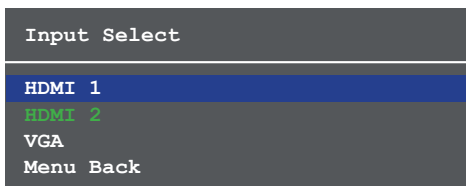

5. Press the **DISPLAY** button to confirm the selection.
6. Press the **Menu Back** option to return to the **Main Menu**.

### Input Resolution

Selects the desired input resolution.

1. Under the **Main Menu**, highlight the **Input Select** menu item using the **VOL UP/DN** buttons on the front panel.
2. Press the **DISPLAY** button.
3. The **Input Resolution** menu will be displayed.
4. Press the **VOL UP/DN** buttons to highlight the desired input.
5. Press the **DISPLAY** button to confirm the selection and display the list of available input resolutions.

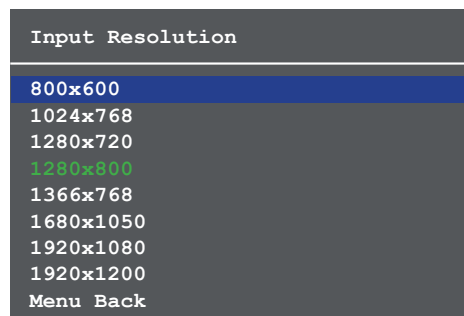
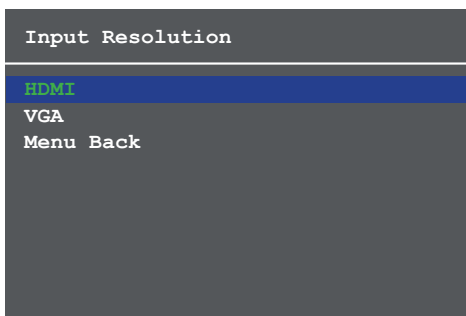

6. Press the **VOL UP/DN** buttons to select the desired resolution.
7. Press the **DISPLAY** button to confirm the selection.
8. Press the **Menu Back** option to return to the **Main Menu**.

### Output Resolution

Selects the desired output resolution. The default output resolution is 720p (1280x720). The Output Resolution menu consists of three pages.

1. Under the **Main Menu**, highlight the **Output Resolution** menu item using the **VOL UP/DN** buttons on the front panel.
2. Press the **DISPLAY** button.
3. The **Output Resolution** menu will be displayed.
4. Press the **VOL UP/DN** buttons to highlight the desired resolution.

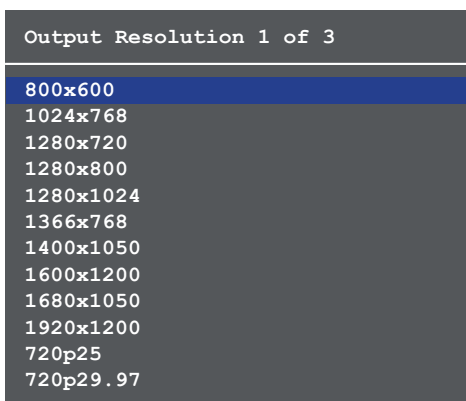

5. Press the **DISPLAY** button to confirm the selection.
6. Select the **Menu Back** option, under **Output Resolution 3 of 3**, then press the **DISPLAY** button, to return to the **Main Menu**.

### Picture Adjust

Provides custom adjustment of picture brightness, contrast, saturation, hue, and color space.

1. Under the **Main Menu**, highlight the **Output Resolution** menu item using the **VOL UP/DN** buttons on the front panel.
2. Press the **DISPLAY** button.
3. The **Picture Adjust** menu will be displayed.
4. Press the **VOL UP/DN** buttons to highlight the desired option.

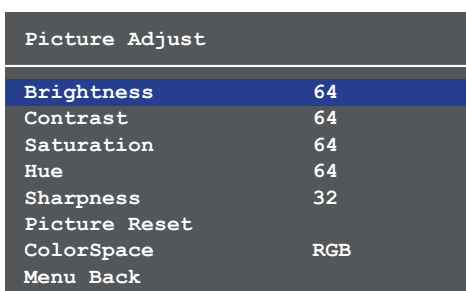

5. Press the **DISPLAY** button to confirm the selection.
6. The current value will be highlighted in green and surrounded by brackets and two arrowheads.

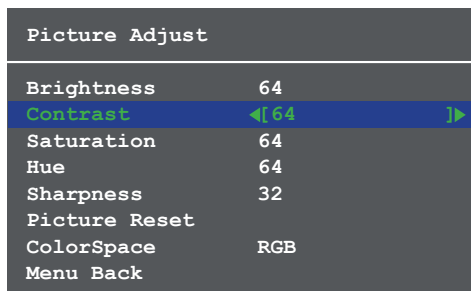

8. Press the **VOL UP/DN** buttons to select the desired value. Press the **VOL UP** button to increase the value; press **VOL DN** to decrease the value.
9. Press the **DISPLAY** button to confirm the new value.
10. Select the **Menu Back** option, then press the **DISPLAY** button, to return to the **Main Menu**.

### Aspect

Allows the aspect ratio of the output image to be changed.

1. Under the **Main Menu**, highlight the **Output Resolution** menu item using the **VOL UP/DN** buttons on the front panel.
2. Press the **DISPLAY** button.
3. The **Aspect** menu will be displayed.
4. Press the **VOL UP/DN** buttons to highlight the desired aspect ratio.

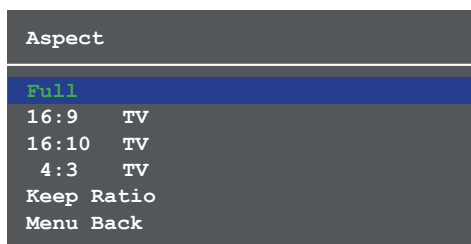

Setting	Description
Full	The output signal will be scaled to fill the screen.
16:9 TV	The output signal will be scaled to fit as 16:9.
16:10 TV	The output signal will be scaled to fit as 16:10.
4:3 TV	Output signal will be set to 4:3. If the input is HD, approximately 35% of the total horizontal resolution will be lost.
Keep Ratio	The input aspect ratio is preserved on the output.

5. Press the **DISPLAY** button to confirm the selection.
6. Select the **Menu Back** option, then press the **DISPLAY** button, to return to the **Main Menu**.

## Configuration and Management Interfaces

### Overscan

Adjusts the overscan setting of the output video signal. By default, overscan is *disabled*.

1. Under the **Main Menu**, highlight the **Overscan** menu item using the **VOL UP/DN** buttons on the front panel.
2. Press the **DISPLAY** button.
3. The **Overscan** menu will be displayed.
4. Press the **VOL UP/DN** buttons to highlight the **Enable** option.
5. Press the **DISPLAY** button to change the **Enable** value

Overscan	
Enable	◀[No]▶
H Size %	0
V Size %	0
Menu Back	

Overscan	
Enable	Yes
H Size %	0
V Size %	0
Menu Back	

6. When overscan is *enabled*, the **H Size %** and **V Size %** fields can be adjusted. Press the **VOL UP/DN** buttons to highlight the desired field.
7. Press the **DISPLAY** button to select the field.
8. Press the **VOL UP/DN** buttons to change the value. Press the **VOL UP** button to *increase* the value; press the **VOL DN** button to *decrease* the value.
9. Press the **DISPLAY** button to confirm the change.
10. Highlight the **Menu Back** option, then press the **DISPLAY** button to return to the **Main Menu**.

### Audio

The Audio menu allows adjustment of all audio settings.

1. Under the **Main Menu**, highlight the **Audio** menu item using the **VOL UP/DN** buttons on the front panel.
2. Press the **DISPLAY** button.
3. The **Audio** menu will be displayed.

Audio	
Audio On Off	On
HDMI Audio	On
L R Audio	On
Treble	0
Bass	0
HDMI1 EBD. Aud	Auto
HDMI2 EBD. Aud	Auto
Menu Back	

4. Press the **VOL UP/DN** buttons to highlight the desired option.
5. Press the **DISPLAY** button to confirm the selection.
6. The current value will be highlighted in green and surrounded by brackets and two arrowheads.

## Configuration and Management Interfaces

Audio	
Audio On Off	On
HDMI Audio	On
L R Audio	On
Treble	◀ +15 ▶
Bass	0
HDMI1 EBD. Aud	Auto
HDMI2 EBD. Aud	Auto
Menu Back	

Setting	Description
Audio On Off	Provides muting of both HDMI and analog audio outputs. Set this value to Off to mute all audio.
HDMI Audio	Controls the HDMI audio, only. Set to Off to mute the HDMI audio.
L R Audio	Toggles the analog audio output On or Off. Set to Off to mute the analog audio output.
Treble	Sets the amount of treble on the audio output. Range is -12 to 15.
Bass	Sets the amount of bass on the audio output. Range is -12 to 15.
HDMI1 EBD. Aud	Selects the audio source to be embedded on HDMI 1. <ul style="list-style-type: none"> <li>• <b>Auto</b> - Automatically uses the analog audio input when using DVI sources. When set to Auto, and an HDMI signal is used, the output audio will be from the HDMI input signal.</li> <li>• <b>Digital</b> - Uses audio from HDMI 1.</li> <li>• <b>Analog</b> - Forces the analog audio input to be used and embeds it on the HDMI output.</li> </ul>
HDMI2 EBD. Aud	Selects the audio source to be embedded on HDMI 2. <ul style="list-style-type: none"> <li>• <b>Auto</b> - Automatically uses the analog audio input when using DVI sources. If an HDMI signal is used, when set to Auto, the output audio will be from the HDMI input signal.</li> <li>• <b>Digital</b> - Uses audio from HDMI 2.</li> <li>• <b>Analog</b> - Forces the analog audio input to be used and embeds it on the HDMI output.</li> </ul>

7. Press the **VOL UP/DN** buttons to select the desired value. Press the **VOL UP** button to increase the value; press **VOL DN** to decrease the value.
8. Press the **DISPLAY** button to confirm the value.
9. Highlight the **Menu Back** option, then press the **DISPLAY** button to return to the **Main Menu**.

## Configuration and Management Interfaces

### OSD

Adjusts the appearance and position of the On-Screen Display (OSD) on the screen.

1. Under the **Main Menu**, highlight the **Audio** menu item using the **VOL UP/DN** buttons on the front panel.
2. Press the **DISPLAY** button.
3. The **OSD** menu will be displayed.
4. Press the **VOL UP/DN** buttons to highlight the desired option.

OSD	
Position	Left Top
Transparency	12
Info. Timer	10
Menu Timer	20
Info. Display	Auto
Background	Grey
Menu Back	

Setting	Description
Position	Sets the position of the OSD on the display. The following options are available: <ul style="list-style-type: none"> <li>• <b>Left Top</b></li> <li>• <b>Right Top</b></li> <li>• <b>Right Bottom</b></li> <li>• <b>Left Bottom</b></li> <li>• <b>Center</b></li> </ul>
Transparency	Adjusts the transparency setting of the OSD. <ul style="list-style-type: none"> <li>• <b>Range:</b> 5 to 100</li> </ul>
Info. Timer	The duration, in seconds, of how long the Display Info screen is displayed. <ul style="list-style-type: none"> <li>• <b>Range:</b> 5 to 100</li> </ul>
Menu Timer	The duration, in seconds, of how long the OSD remains on the screen, after no activity. <ul style="list-style-type: none"> <li>• <b>Range:</b> 5 to 100</li> </ul>
Info. Display	Adjusts the display settings of the <b>Info Display</b> screen, which indicates the input and output resolution. Refer to the next page for an example of the Info Display screen. The following options are available: <ul style="list-style-type: none"> <li>• <b>Auto</b> - Automatically displays the Info Display screen when a change is made to the input or output signal. The screen will automatically be hidden after approximately five seconds.</li> <li>• <b>Off</b> - Prevents the Info Display screen from being displayed.</li> <li>• <b>On</b> - The Info Display screen is always displayed.</li> </ul>
Background	Sets the background color of the OSD. The following options are available: <ul style="list-style-type: none"> <li>• <b>Grey</b></li> <li>• <b>Cyan</b></li> <li>• <b>Magenta</b></li> <li>• <b>Yellow</b></li> </ul>



## Configuration and Management Interfaces

5. Press the **DISPLAY** button to confirm the selection.
6. The current value will be highlighted in green and surrounded by brackets and two arrowheads.
7. Press the **VOL UP/DN** buttons to change the value. For settings that contain a value, press the **VOL UP** button to *increase* the value; press the **VOL DN** button to *decrease* the value.

OSD	
Position	Left Top
Transparency	<[12]>
Info. Timer	10
Menu Timer	20
Info. Display	Auto
Background	Grey
Menu Back	

Info Display screen

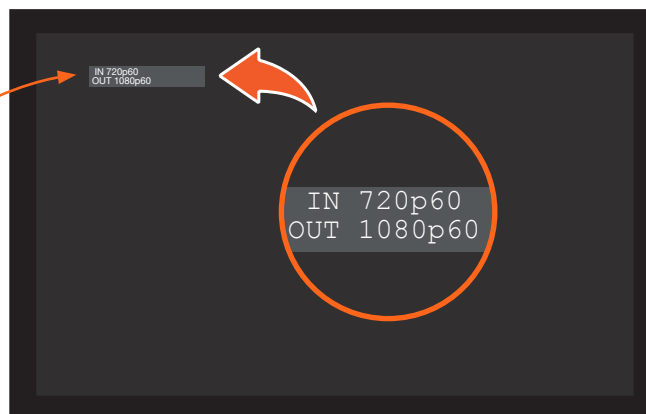

8. Press the **DISPLAY** button to confirm the change.
9. Highlight the **Menu Back** option, then press the **DISPLAY** button to return to the **Main Menu**.

### Control Settings

Adjusts the control settings.

1. Under the **Main Menu**, highlight the **Control Settings** menu item using the **VOL UP/DN** buttons on the front panel.
2. Press the **DISPLAY** button.
3. The **Control Settings** menu will be displayed.
4. Press the **VOL UP/DN** buttons to highlight the desired option.

Control Settings	
CEC	On
BTN Vol. Sel	Audio Out
Auto Disp. On	Off
Auto Disp. Off	Off
Disp. Key Lock	Off
Cool Down Tmr	0
Auto Power Off	15
Warm Up Timer	0
Control Type	RS-232
Feedback Vrfy.	Off
Menu Back	

Setting	Description
CEC (see CEC note on next page)	<p>Enables or disables Consumer Electronics Control (CEC) command transmission to the display (sink) device.</p> <ul style="list-style-type: none"> <li>• <b>On</b> - Allows CEC commands to be transmitted over the HDMI cable to the connected display (sink) device.</li> <li>• <b>Off</b> - Prevents transmission of CEC commands.</li> </ul>

## Configuration and Management Interfaces

\* *Consumer Electronics Control (CEC): Atlona has confirmed proper CEC functionality with several current models of Samsung, Panasonic, and Sony displays. However, it is not guaranteed that CEC will work with all displays. Many manufacturers do not support the CEC “off” command, and older displays use proprietary commands. Atlona only supports displays that use the CEC command structure defined in HDMI 1.2a. It is recommended that dealers request an evaluation product from Atlona, before designing a system using the CEC protocol. If this is not possible, then other control methods will need to be considered, in order to control displays using Atlona products.*

Setting	Description
BTN Vol. Sel	Sets the delivery method used by the <b>VOL UP / DN</b> buttons. <ul style="list-style-type: none"> <li>• <b>Audio Out</b> - Directly controls the output volume on the connected display (sink) device.</li> <li>• <b>RS-232</b> - Volume commands are sent over RS-232, to the connected display.</li> <li>• <b>IP</b> - Volume commands are sent over IP, to the connected display.</li> </ul>
Auto Disp. On	Sends the command to power-on the display when an A/V signal is detected. The following options are available: <ul style="list-style-type: none"> <li>• <b>On</b> - Enables the feature.</li> <li>• <b>Off</b> - Disables the feature.</li> </ul>
Auto Disp. Off	Sends the command to power-off the display when an A/V signal is no longer present. The following options are available: <ul style="list-style-type: none"> <li>• <b>On</b> - Enables the feature.</li> <li>• <b>Off</b> - Disables the feature.</li> </ul>
Disp. Key Lock	Allows the <b>DISPLAY</b> button to be locked, preventing accidental operation when the product is in use. Define the time interval using the Warm Up Timer option, below. The following options are available: <ul style="list-style-type: none"> <li>• <b>On</b> - Enables the feature.</li> <li>• <b>Off</b> - Disables the feature.</li> </ul>
Cool Down Tmr	Sets the cool-down interval, in seconds, before the projector can be powered-off. During this time interval, the projector will not accept any commands until the “power off” command has been processed, requiring the projector lamp to complete the cool-down process. <ul style="list-style-type: none"> <li>• <b>Range:</b> 0 to 300</li> </ul>
Auto Power Off	Sets the time interval, in seconds, between when the loss of A/V signal is detected and when the “Display Off” command is sent. <ul style="list-style-type: none"> <li>• <b>Range:</b> 0 to 240</li> </ul>
Warm Up Timer	Sets the time interval, in seconds, between when the display is powered-on and when the <b>DISPLAY</b> button, on the front panel, will be locked. <ul style="list-style-type: none"> <li>• <b>Range:</b> 0 to 300</li> </ul>
Control Type	Sets the control method for sending commands. The following options are available: <ul style="list-style-type: none"> <li>• <b>RS-232</b></li> <li>• <b>IP</b></li> <li>• <b>CEC</b></li> </ul>
Feedback Vrfy.	Sets the feedback verification state. The following options are available: <ul style="list-style-type: none"> <li>• <b>On</b> - The AT-HD-SC-500 will make four attempts to send the command. If the feedback string is not acknowledged after the fourth attempt, the process will fail. Execute the <a href="#">SetCmdFB (page 26)</a> command to set the feedback string.</li> <li>• <b>Off</b> - Sends the command and ignores the feedback string.</li> </ul>

## Configuration and Management Interfaces

5. Press the **DISPLAY** button to confirm the selection.
6. The current value will be highlighted in green and surrounded by brackets and two arrowheads.
7. Press the **VOL UP/DN** buttons to change the value.
8. Press the **DISPLAY** button to confirm the change.
9. Highlight the **Menu Back** option, then press the **DISPLAY** button to return to the **Main Menu**.

### Others

This menu provides control for various other settings, such as auto-switching, HDCP, and vertical mirroring.

1. Under the **Main Menu**, highlight the **Others** menu item using the **VOL UP/DN** buttons on the front panel.
2. Press the **DISPLAY** button.
3. The **Others** menu will be displayed.
4. Press the **VOL UP/DN** buttons to highlight the desired option.

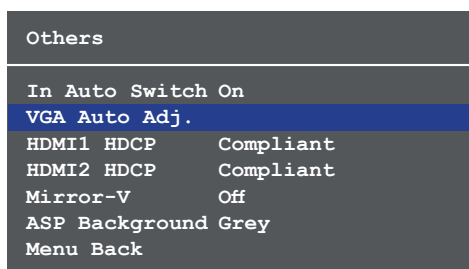

Setting	Description
In Auto Switch	Enables or disables auto-switching. The following options are available: <ul style="list-style-type: none"> <li>• <b>On</b> - Enables auto-switching.</li> <li>• <b>Off</b> - Disables auto-switching.</li> </ul>
VGA Auto Adj.	Centers the VGA signal by automatically adjusting the horizontal position. This feature is only available when a VGA source is connected to the switcher.
HDMI1 HDCP	Provides control over the transmission of HDCP content for HDMI 1. The following options are available: <ul style="list-style-type: none"> <li>• <b>Compliant</b> - Forces detection of HDCP-compliant sink devices. If the sink device is not HDCP-compliant, then no content will be transmitted.</li> <li>• <b>Noncompliant</b> - Suppresses detection of HDCP-compliant sink devices, allowing non-HDCP content to be transmitted.</li> <li>• <b>Auto</b> - Automatically detects the presence of HDCP-compliant sink devices. If an HDCP-compliant display is detected, then HDCP content will be sent. Otherwise, non-HDCP content will be sent.</li> </ul> <p><b>NOTE:</b> Some source devices will enable HDCP if an HDCP-compliant display (sink) is detected. However, there may be applications where sending HDCP content is not desired. This feature does <b>not</b> provide decryption of HDCP content to non-HDCP sink devices</p>

## Configuration and Management Interfaces

Setting	Description
HDMI2 HDCP	<p>Provides control over the transmission of HDCP content for HDMI 2. Refer to note, on the previous page. The following options are available:</p> <ul style="list-style-type: none"> <li>• <b>Compliant</b> - Forces detection of HDCP-compliant sink devices. If the sink device is not HDCP-compliant, then no content will be transmitted.</li> <li>• <b>Noncompliant</b> - Suppresses detection of HDCP-compliant sink devices, allowing non-HDCP content to be transmitted.</li> <li>• <b>Auto</b> - Automatically detects the presence of HDCP-compliant sink devices.</li> </ul>
Mirror-V	<p>Vertically flips the output signal. The default setting is Off. The following options are available:</p> <ul style="list-style-type: none"> <li>• <b>On</b> - Vertically flips the output image.</li> <li>• <b>Off</b> - The output image is unaltered.</li> </ul>
ASP Background	<p>Changes the color of background bars when changing the aspect ratio of the output image. The default color is Black. The following options are available:</p> <ul style="list-style-type: none"> <li>• <b>Black</b></li> <li>• <b>Grey</b></li> </ul>

5. Press the **DISPLAY** button to confirm the selection.
6. The current value will be highlighted in green and surrounded by brackets and two arrowheads.
7. Press the **VOL UP/DN** buttons to change the value.
8. Press the **DISPLAY** button to confirm the change.
9. Highlight the **Menu Back** option, then press the **DISPLAY** button to return to the **Main Menu**.

### Information

The Information displays current information about the AT-HD-SC-500. None of the fields within the **Information** menu can be edited.

1. Under the **Main Menu**, highlight the **Information** menu item using the **VOL UP/DN** buttons on the front panel.
2. Press the **DISPLAY** button.
3. The **Information** menu will be displayed.

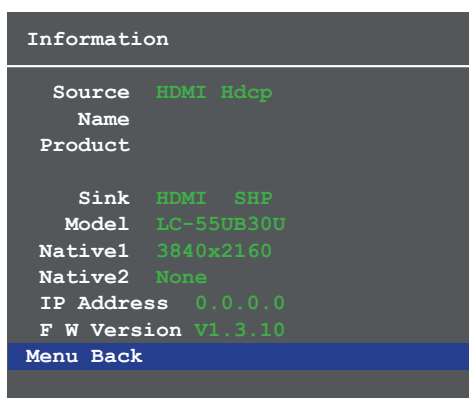

Setting	Description
Source	The current input source that is displayed. The source will be displayed as HDMI or VGA. If HDCP content is transmitted (HDMI only), then “Hdcp” will be displayed.
Name	The name of the source, if available.
Product	The product name, if available.
Sink	Contains the manufacturer’s abbreviation of the sink.
Model	Displays the model of the display.
Native1	The native (preferred) timing for the display.
Native2	Displays any detailed (alternate) timing for the display.
IP Address	IP address of the display.
F W Version	Current version of firmware running on the switcher.

4. The Menu Back option will already be selected.
5. Press the **DISPLAY** button to return to the **Main Menu**.

### The Web GUI

The AT-HD-SC-500 includes a built-in web GUI. Atlona recommends that the web GUI be used to control the AT-HD-SC-500, as it provides intuitive management of all features.

The AT-HD-SC-500 is shipped with DHCP enabled. Once connected to a network, the DHCP server will automatically assign an IP address to the unit. If a DHCP server is not available or if a static IP address is desired, it can be assigned using the [IPStatic \(page 20\)](#) command or through the [Network Page \(page 44\)](#) in the web GUI. The default IP address of the AT-HD-SC-500 is 192.168.1.254.

#### Logging In

1. Launch a web browser.
2. In the address bar, type the IP address of the AT-HD-SC-500.
3. The **Login** page will be displayed.



4. Type `root`, using all lower-case characters, in the **Username** field. The username cannot be altered.
5. Type `Atlona` in the **Password** field. The password field is case-sensitive. When the password is entered, it will be masked. The password can be changed through the [Config Page \(page 43\)](#) of the web GUI.
6. Click the **Submit** button or press the ENTER key on the keyboard.

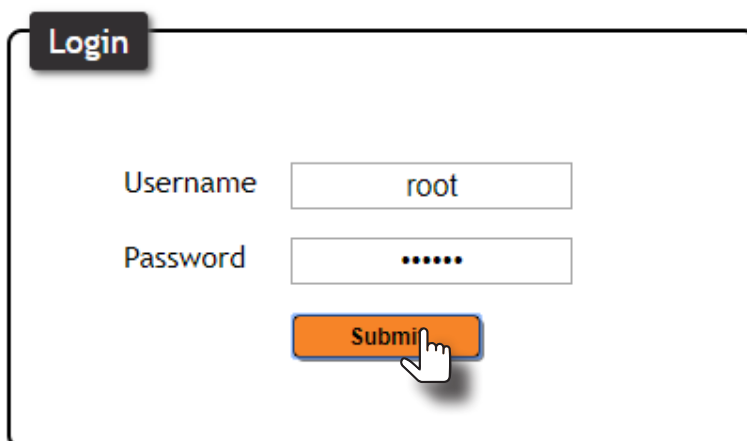

## Configuration and Management Interfaces

7. The **Info** page will be displayed.

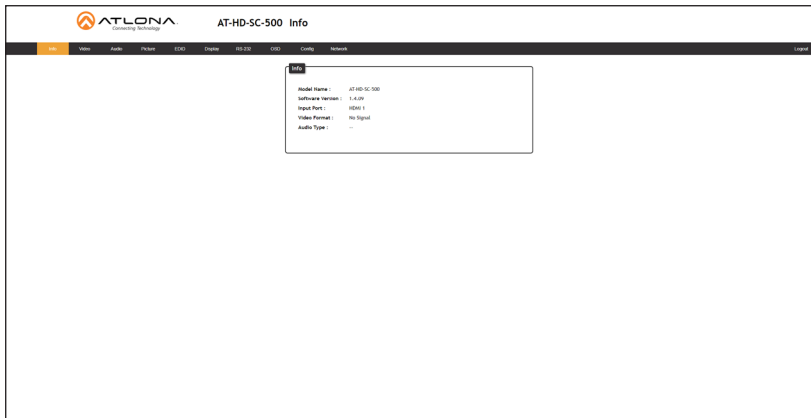

### Menus

The dark-colored bar, near the top of the screen, is the menu bar. When the mouse is moved over each menu element, it will be highlighted in light orange. Once the desired menu element is highlighted, click the left mouse button to access the settings within the menu.

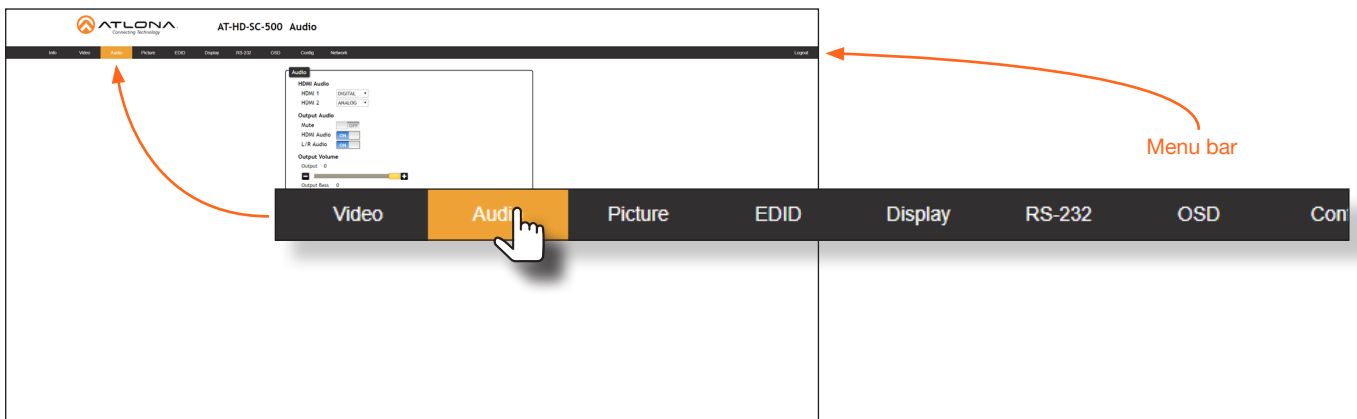

In this example, clicking **Audio**, in the menu bar, will display the **Audio** page.

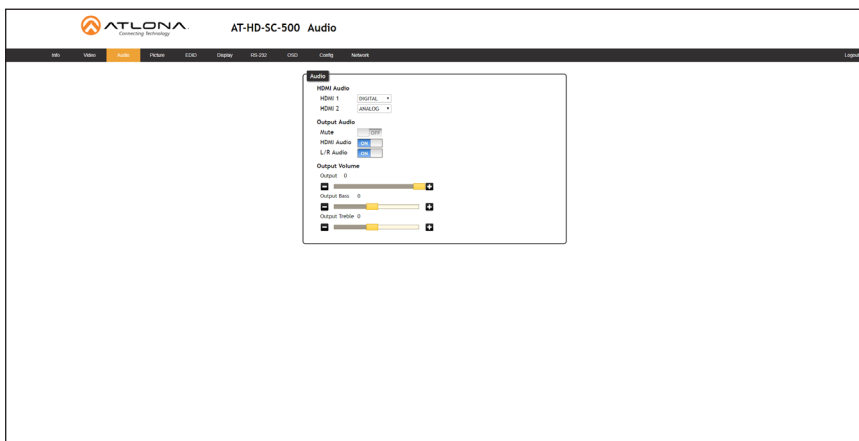

## Configuration and Management Interfaces

### Toggles

Several settings within the Web GUI use *toggles*, which enable, disable, or assign one of two settings. In most cases, when the *toggle* is blue, this means the feature is enabled. In addition, the *toggle* will be set to the ON or ENABLED position. If a feature is disabled, then the *toggle* will appear gray and be labeled as OFF or DISABLED.



In some cases, the *toggle* will allow switching between two settings, such as the **IP Mode** setting, under the **Network** Page. This *toggle* sets the AT-HD-SC-500 to either static or DHCP mode. Refer to [Network Page \(page 44\)](#) for more information on this feature.

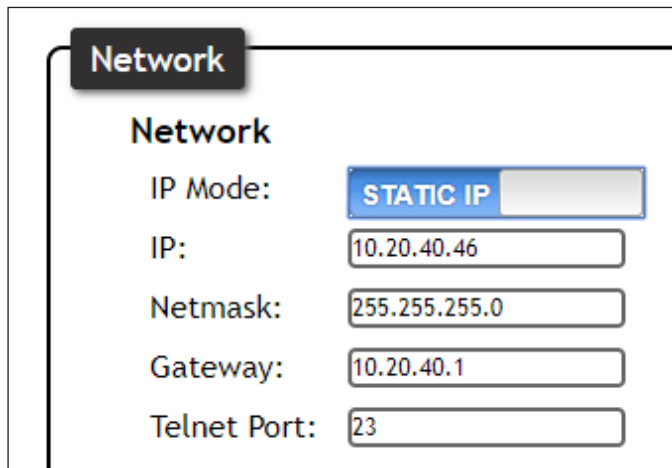

### Sliders

Click and drag slider controls to change their value.

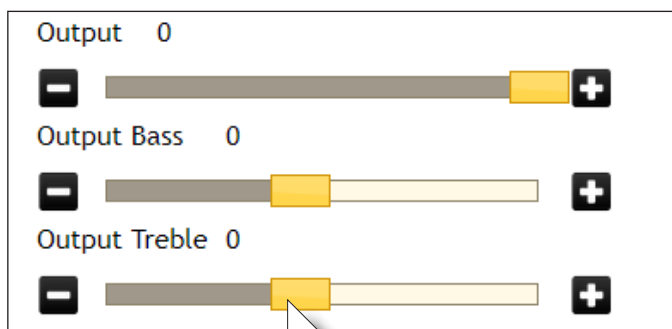



## Configuration and Management Interfaces

### Buttons

Buttons are used to execute an action or setting. Several pages within the Web GUI include a **Save** button. Clicking the **Save** button will apply and save all settings in the current page. Other buttons, such as the **Power** command for **CEC** (found under the **Display** page), will send the power-on or power-off command to the display.

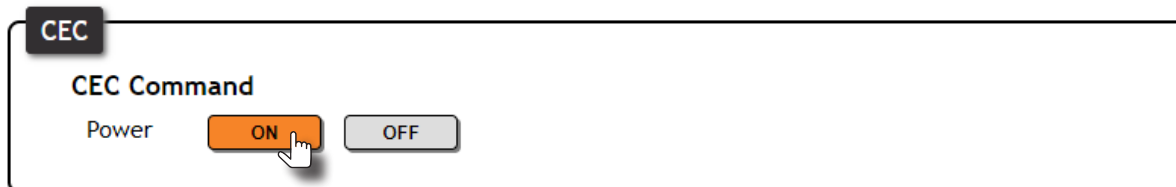

### Getting Information on the Switcher

After logging in, the Info page will be displayed. The **Info** page displays the model and firmware version of the switcher. In addition, the active input, video format, and audio type are also reported. No fields can be edited on this page. To access this page from any menu, click **Info** in the menu bar.

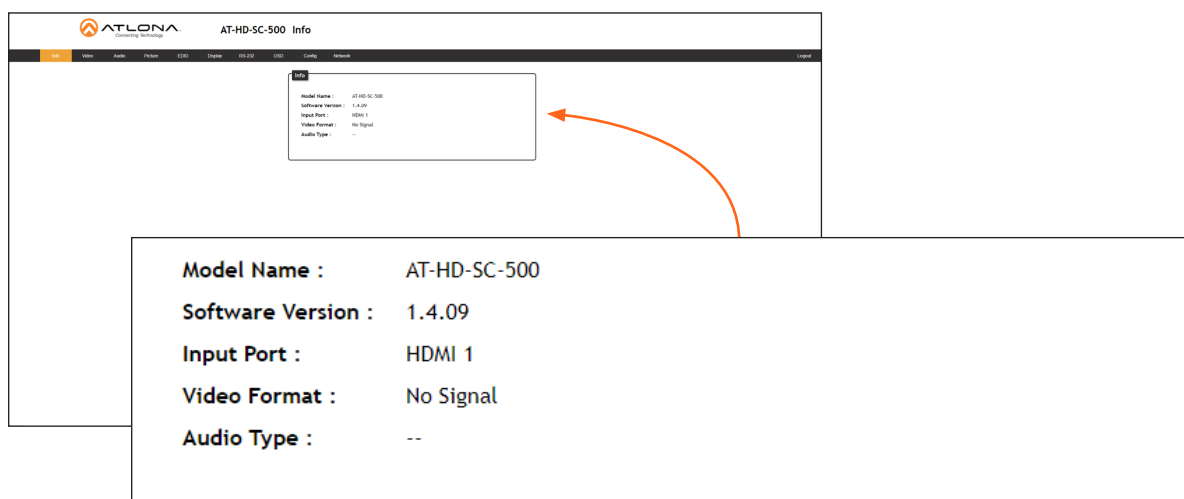

Setting	Description
Model Name	The model name of this switcher.
Software Version	The version of firmware that the AT-HD-SC-500 is running. Always make sure to check the AT-HD-SC-500 product page, on the Atlona web site, for the latest version of firmware.
Input Port	The active input port on the switcher.
Video Format	The video format of the input signal. If no input signal is detected, then No Signal will appear in this field.
Audio Type	The audio format of the input signal. If no audio is available, this field will display two dash symbols, as shown above.

## Video Page

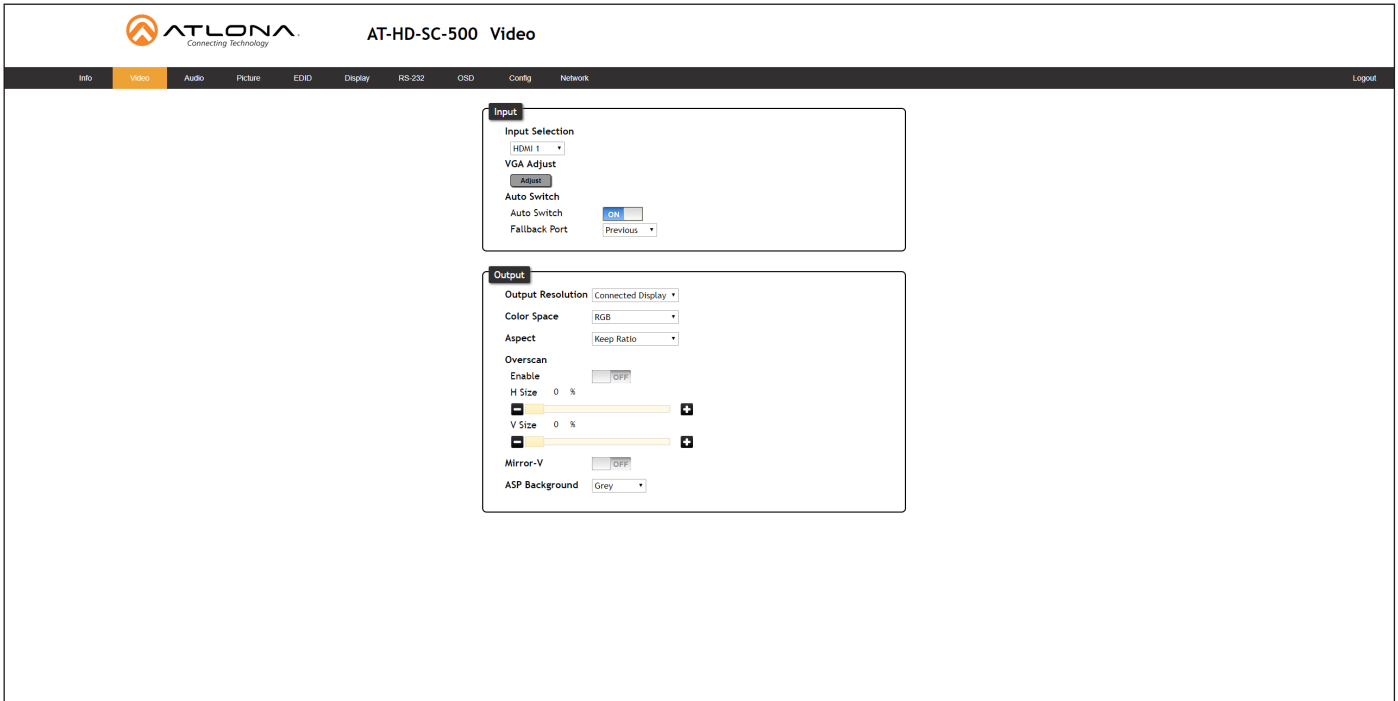

## Input

### Input Selection

Click this drop-down list to select the desired input.

### VGA Adjust

In most situations, adjustment of the VGA signal should not necessary. However, if the VGA signal does not appear correctly, click the **Adjust** button to automatically correct the clock and phase.

### Auto Switch

Three controls are available under the Auto Switch feature.

- Click the Auto Switch mode toggle to enable or disable auto-switching.
- Click the **Fallback Port** drop-down list to select the fallback port. If the source is disconnected from the active port, then the switcher can be configured to automatically switch to the desired port. Click the Auto Switch mode toggle to enable or disable auto-switching.

Setting	Description
HDMI 1	Automatically switches to HDMI 1.
HDMI 2	Automatically switches to HDMI 2.
VGA	Automatically switches to VGA.
Previous	The switcher will return to the previous (last connected) input. If no input is found, then it will attempt to switch to a ternary port.

- Click the **Fallback Time (Sec)** drop-down list and select the time interval before the switcher attempts to search for the next port. Range: 3 to 600.

## Configuration and Management Interfaces

### Output

#### Output Resolution

Click the **Output Resolution** drop-down list and select the desired resolution. The default resolution is 720p.

Output Resolutions			
800x600p60	1600x1200p60	1280x720p59	1920x1080p25
1024x768p60	1680x1050p60	1280x720p60	1920x1080p29
1280x800p60	1920x1200pRB	1920x1080i50	1920x1080p30
1280x1024p60	1280x720p25	1920x1080i59	1920x1080p50
1366x768p60	1280x720p29	1920x1080i60	1920x1080p59
1400x1050p60	1280x720p30	1920x1080p23	1920x1080p60
1600x900p60	1280x720p50	1920x1080p24	NATIVE

#### Color Space

Click the **Color Space** drop-down list and select the desired color space.

#### Aspect

Click the **Aspect** drop-down list and select the desired aspect ratio.

Aspect Ratio	Description
Full	The input signal is adjusted to fill the screen.
16:9	Set the aspect ratio to 16:9; common aspect ratio for HD and widescreen formats; also notated as 1:77.1
16:10	Set the aspect ratio to 16:10; typical aspect ratio for computer and tablet displays.
4:3	Sets the aspect ratio to 4:3; if the input signal is 16:9 or 16:10, up to 30% of the vertical resolution is lost.
Keep Ratio	The output aspect ratio is the same as the input.

#### Overscan

Adjust the overscan of the output signal. Before the overscan can be adjusted, click the **Enable** toggle to the ON setting. Click and drag the *slider* controls to adjust the horizontal and vertical size. The **Enable** toggle must remain in the ON position, in order for the overscan to be applied. To disable overscan, click the **Enable** toggle to the OFF position.

#### Mirror-V

Click the **Mirror-V** toggle to the ON setting. Enabling this feature applies a vertical transformation (rotated 180° about the x-axis) to the output signal.

#### ASP Background

Click this drop-down list to select the color of the bars that appear when viewing an image in “letterbox” format.

### Audio Page

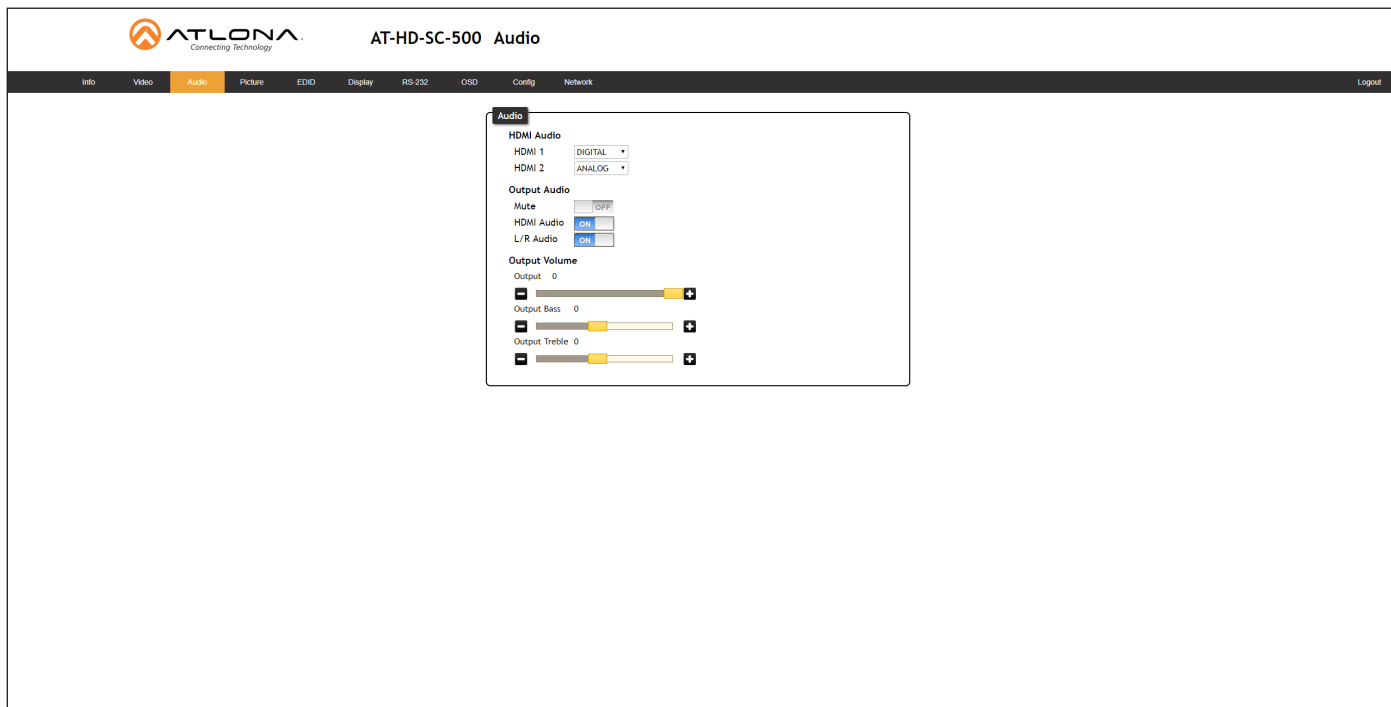

#### HDMI Audio

Click the drop-down list for HDMI 1 and HDMI 2 to select the input audio source used by each HDMI input.

Setting	Description
Auto	Automatically detects the audio source. If an HDMI cable with embedded audio is connected, the system will use the digital audio on the HDMI cable. If a cable, which does not support audio (such as a DVI cable) is connected to the HDMI port, then the analog audio from the <b>AUDIO IN</b> port will be used.
Digital	The HDMI audio will be used as the source.
Analog	The analog source, connected to the <b>AUDIO IN</b> port, will be used.

#### Mute

Click this toggle to the **OFF** position to mute all audio on the output.

#### HDMI Audio

Click this toggle to the **OFF** position to mute only the HDMI audio.

#### L/R Audio

Click this toggle to the **OFF** position to mute all audio on the output.

#### Volume

Click and drag this slider bar to adjust the audio volume. Range: -80 to 6.

#### Output Bass

Click and drag this slider bar to adjust the bass of the audio output. Range: -15 to 15.

#### Output Treble

Click and drag this slider bar to adjust the treble of the audio output. Range: -15 to 15.

### Picture Page

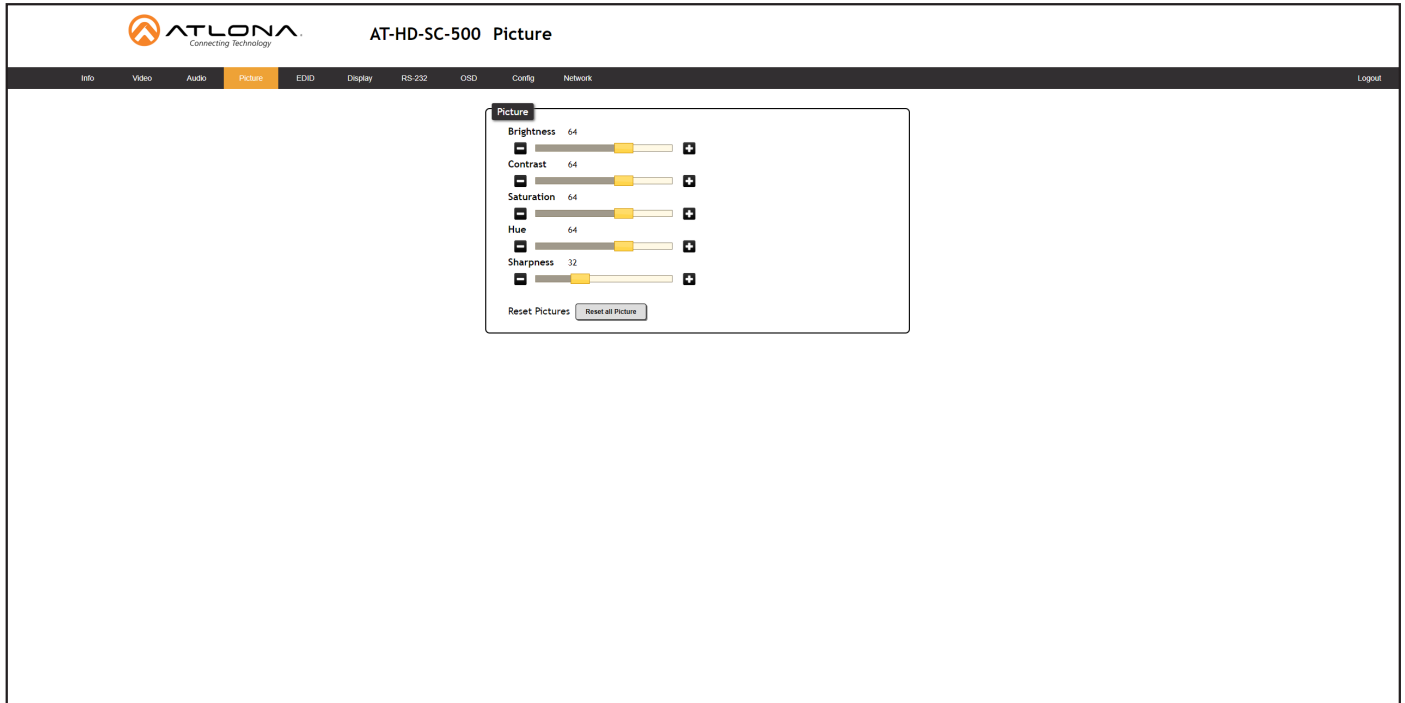

#### **Brightness**

Adjusts the brightness setting of the output signal. Range: 0 - 128

#### **Contrast**

Adjusts the contrast setting of the output signal. Contrast is the difference between the lightest and darkest area of an image. Range: 0 - 128

#### **Saturation**

Adjusts the color saturation of the output signal. Range: 0 - 128

#### **Hue**

Adjusts the hue of the output signal. Range: 0 - 128

#### **Sharpness**

Adjusts the sharpness of the output signal. Range: 0 - 128

#### **Reset all Picture**

Click this button to reset the above picture settings to their factory-default settings.

### EDID Page

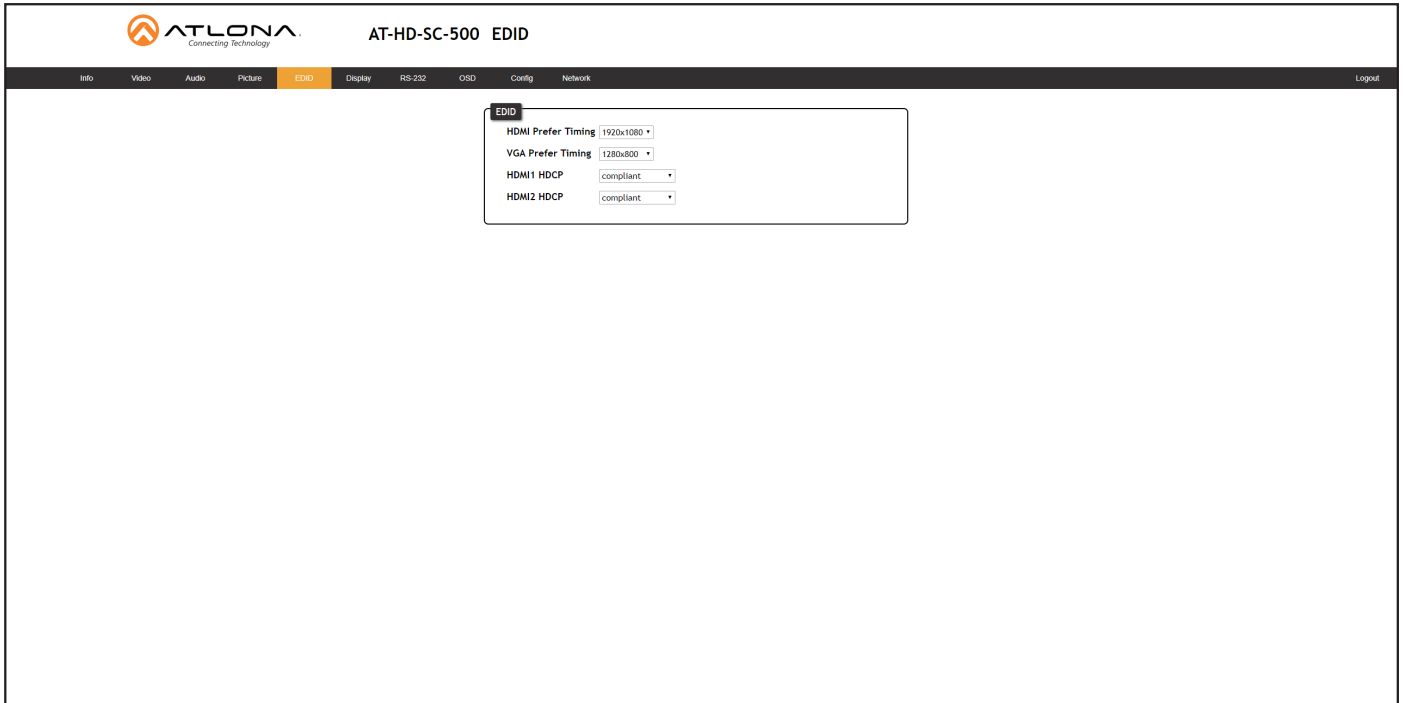

#### HDMI Prefer Timing

Sets the preferred timing for the HDMI input.

#### VGA Prefer Timing

Sets the preferred timing for the VGA input.

#### HDMI1 HDCP

Provides control over the transmission of HDCP content for HDMI 1. The following options are available:

- **Compliant** - Forces detection of HDCP-compliant sink devices. If the sink device is not HDCP-compliant, then no content will be transmitted.
- **Noncompliant** - Suppresses detection of HDCP-compliant sink devices, allowing non-HDCP content to be transmitted.
- **Auto** - Automatically detects the presence of HDCP-compliant sink devices. If an HDCP-compliant display is detected, then HDCP content will be sent. Otherwise, non-HDCP content will be sent.

#### HDMI2 HDCP

Provides control over the transmission of HDCP content for HDMI 2. The following options are available:

- **Compliant** - Forces detection of HDCP-compliant sink devices. If the sink device is not HDCP-compliant, then no content will be transmitted.
- **Noncompliant** - Suppresses detection of HDCP-compliant sink devices, allowing non-HDCP content to be transmitted.
- **Auto** - Automatically detects the presence of HDCP-compliant sink devices. If an HDCP-compliant display is detected, then HDCP content will be sent. Otherwise, non-HDCP content will be sent.



**NOTE:** The HDCP control feature does **not** provide decryption of HDCP content to non-HDCP sink devices.

## Display Page

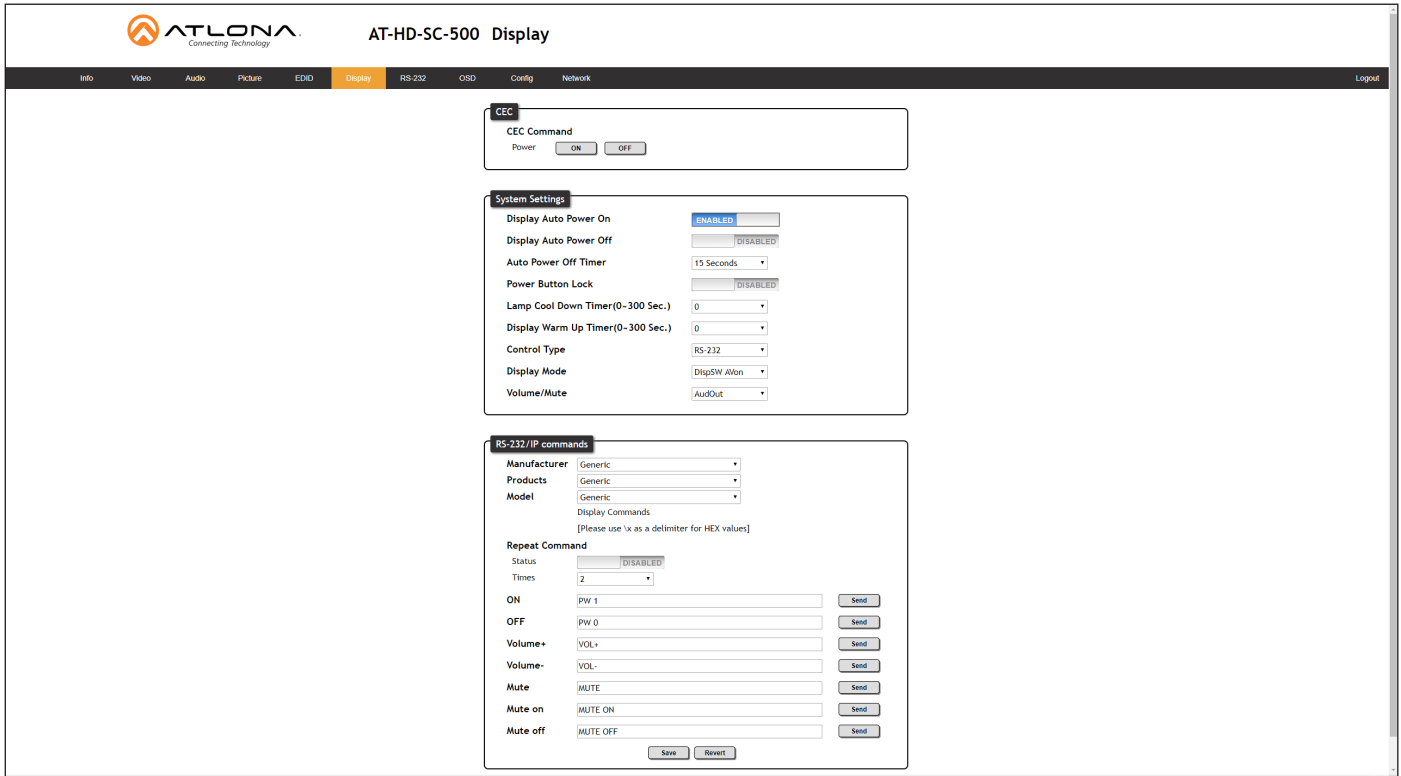

## CEC

### CEC Command

Click the **ON** button to send the power-on command to the display device. Click the **OFF** button to toggle the power state to off.

## System Settings

### Display Auto Power On

Set this toggle to **ENABLED** to allow the AT-HD-SC-500 to send the power-on command to the display when an A/V signal is detected. When the A/V signal is no longer present, the AT-HD-SC-500 will send the power-off command to the display. If this feature is not desired, then set to **DISABLED**. This feature is disabled by default.

### Display Auto Power Off

Set this toggle to **ENABLED** to allow the AT-HD-SC-500 to send the power-off command to the display when an A/V signal is no longer detected.

### Auto Power Off Timer

Sets the time interval before the command to power-off the display is sent, when an A/V signal is no longer present. The default value is 15 seconds. Available values are 5 seconds to 1 hour.

### Power Button Lock

Allows the **DISPLAY** button, on the front panel, to be locked, preventing accidental operation when the product is in use. Define the time interval, before the button is locked, in the **Display Warm Up Timer** field.

### Lamp Cool Down Timer

Sets the cool-down interval, in seconds, before the projector is powered-off. During this time interval, the projector will not accept any "power on" or "power off" commands until the last "power off" command has been processed and the projector lamp has completed the cool-down cycle. Available values are 0 to 300 seconds. The default setting is 15 seconds.

## Configuration and Management Interfaces

### Display Warm Up Timer

Sets the projector lamp warm-up timer, in seconds. During the warm-up interval, the AT-HD-SC-500 will not start the auto power-off timer. This value specifies the time interval that must elapse, after the display control “on” command is sent, before the display “power off” command can be sent. This feature is used to prevent a “power off” command from being sent while the lamps are warming up. Available values are 0 to 300 seconds. The default setting is 15 seconds.

### Control Type

Sets the control method for sending commands. The following options are available: RS-232, IP, CEC.

Setting	Description
RS-232	RS-232 is used to send commands.
IP	Commands are sent over IP.
CEC	Uses CEC to send commands.

### Display Mode

Click this drop-down list to select the display mode.

Setting	Description
DispSW AVon	Display switches on/off, source audio/video signal always on.
DispSW AVSW	Display switches on/off, source audio/video signal switches on/off.
AV SW	Display is always on, source audio/video signal switches on/off

### Volume / Mute

Click this drop-down list to select the control method for volume and muting.

Setting	Description
Audio Out	Volume and mute buttons will control volume level of the output.
RS-232	Volume/Mute buttons will send the commands using RS-232 to compatible extenders and displays.
IP	Volume/Mute buttons will send the commands over Ethernet using the LAN connection.

### Manufacturer

Click this drop-down list to select the manufacturer of the device that is being controlled. If the device manufacturer is not listed, select **Generic**. If **Generic** is selected, then both the **Products** and **Model** fields will be set to **Generic**.

### Products

Click this drop-down list to select the product.

### Model

Click this drop-down list to select the model of the product.

### Status

Click this toggle to enable or disable sending of the command multiple times. Some devices may require that commands be sent multiple times before an acknowledge message is sent back to the AT-HD-SC-500. Refer to the User Manual for the display device for more information. If the command must be repeated, set this toggle to Enable and set the number of times to send the command in the **Times** field.

### Times

Click this drop-down list to select the number of times which the command must be sent to the device, before an acknowledge message is returned. The available values are 2, 3, and 4.

### ON/OFF/Volume+/Volume-/Mute/Mute on/Mute off

Enter the appropriate command string for each function in these fields. Refer to the User Manual of the display device for more information.



### RS-232 Page

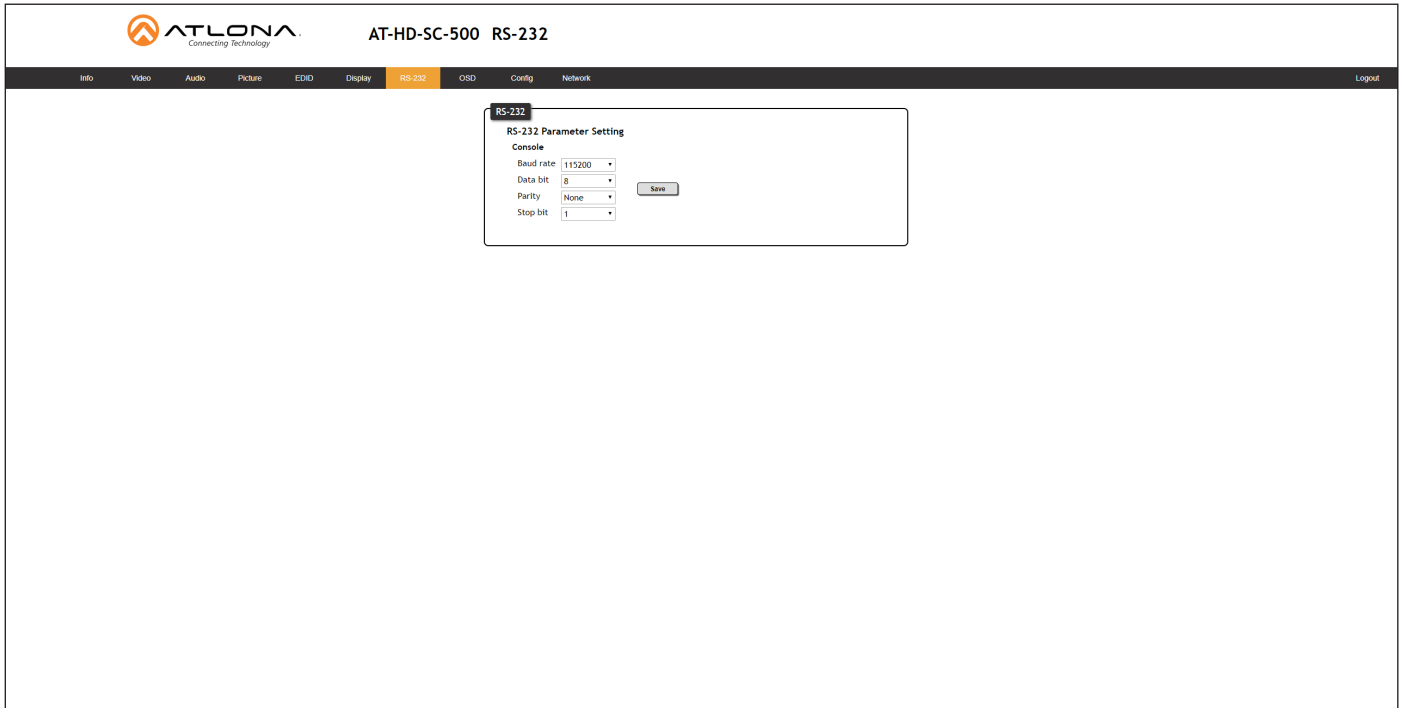

#### Baud rate

Sets the baud rate for the AT-HD-SC-500. The following options are available: 2400, 4800, 9600, 19200, 28800, 57600, 115200.

#### Data bit

Sets the number of data bits used to represent each character of data. The following options are available: 5, 6, 7, 8, 9.

#### Parity

Sets the parity bit, which can be included with each character to detect errors during the transmission of data. The following options are available: None, Odd, or Even.

Setting	Description
None	No parity; error detection is handled by RS-232 protocol.
Odd	Parity will be set to 1 if, for a given set of bits, the count is odd.
Even	Parity will be set to 1 if, for a given set of bits, the count is even.

#### Stop bit

Sets the stop bit. Stop bits are sent at the end of each character, allowing the client to detect the end of a character stream. The following options are available: 1 or 2.

#### Save

Click this button to save all changes to the RS-232 settings.

### OSD Page

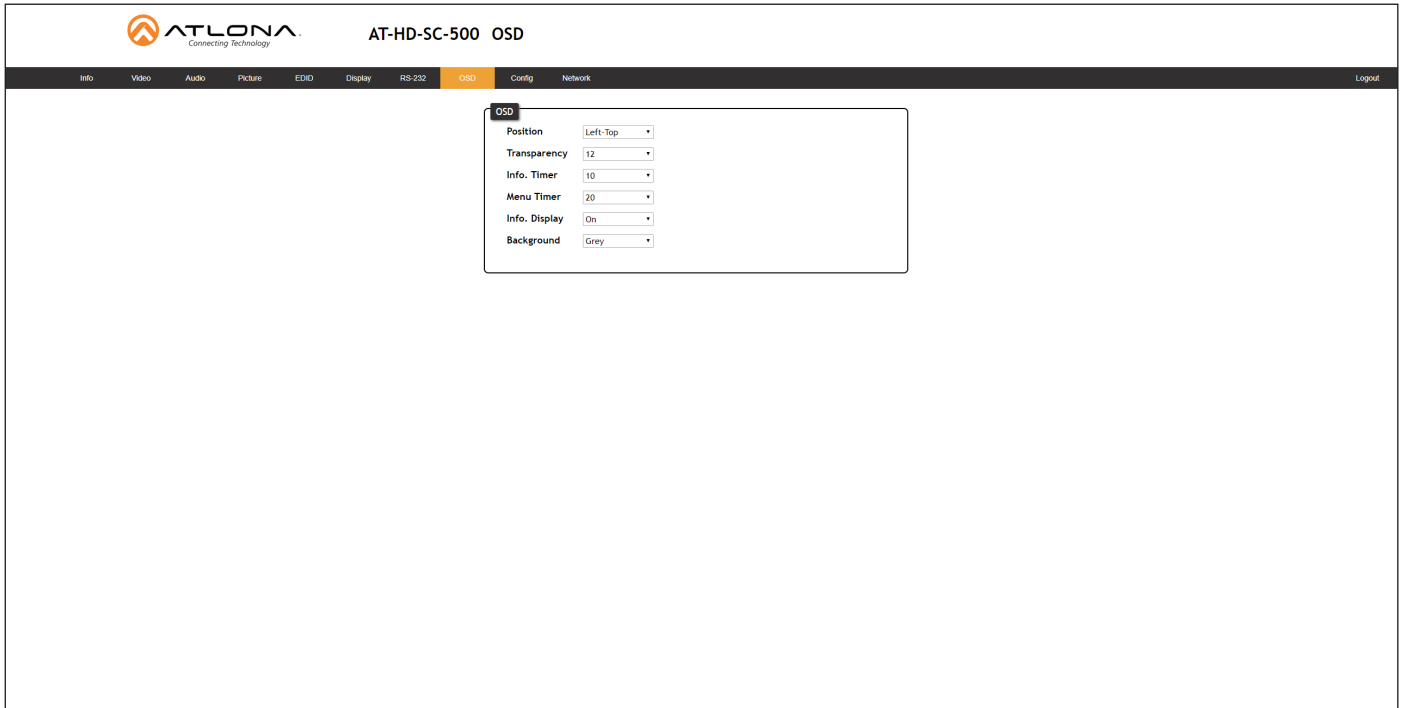

#### Position

Sets the position of the OSD on the display. The following options are available. Left Top, Right Top, Right Bottom, Left Bottom, Center.

#### Transparency

Adjusts the transparency setting of the OSD. Range: 5 to 100.

#### Info Timer

The duration, in seconds, of how long the Display Info screen is displayed.

#### Menu Timer

The duration, in seconds, of how long the OSD remains on the screen after no activity.

#### Info. Display

Adjusts the display settings of the Info Display screen, which indicates the input and output resolution. The following options are available:

Setting	Description
Auto	Automatically displays the Info Display screen when a change is made to the input or output signal. The screen will automatically be hidden after approximately five seconds.
Off	Prevents the Info Display screen from being displayed.
On	The Info Display screen is always displayed.

#### Background

Sets the background color of the OSD. The following options are available: Grey, Cyan, Magenta, Yellow.

## Config Page

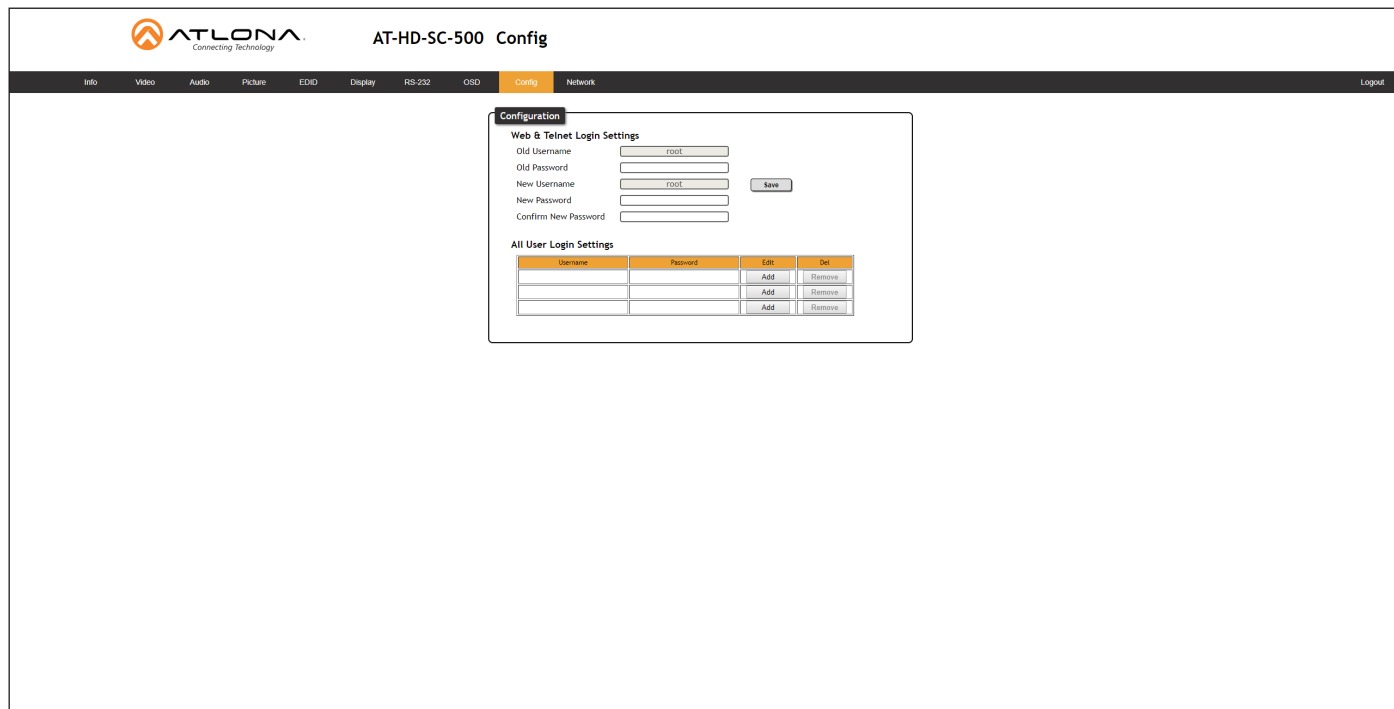

### Old Username

This field cannot be changed. "root" is the administrator user.

### Old Password

Enter the current password for the "root" username in this field. The default password is "Atlona".

### New Username

This field cannot be changed.

### Save

Click this button to save all changes.

### New Password

Enter the new password for the "root" username in this field.

### Confirm New Password

Verify the new password by retyping it in this field.

### All User Login Settings

- **Username**  
Displays the username.
- **Password**  
Displays the password for the associated username.
- **Edit**  
Click the **Add** button, in this column, to edit the username and password in the row.
- **Del**  
Click the **Remove** button to delete the user in the row. This button will only be available if a username and password have been created.

### Network Page

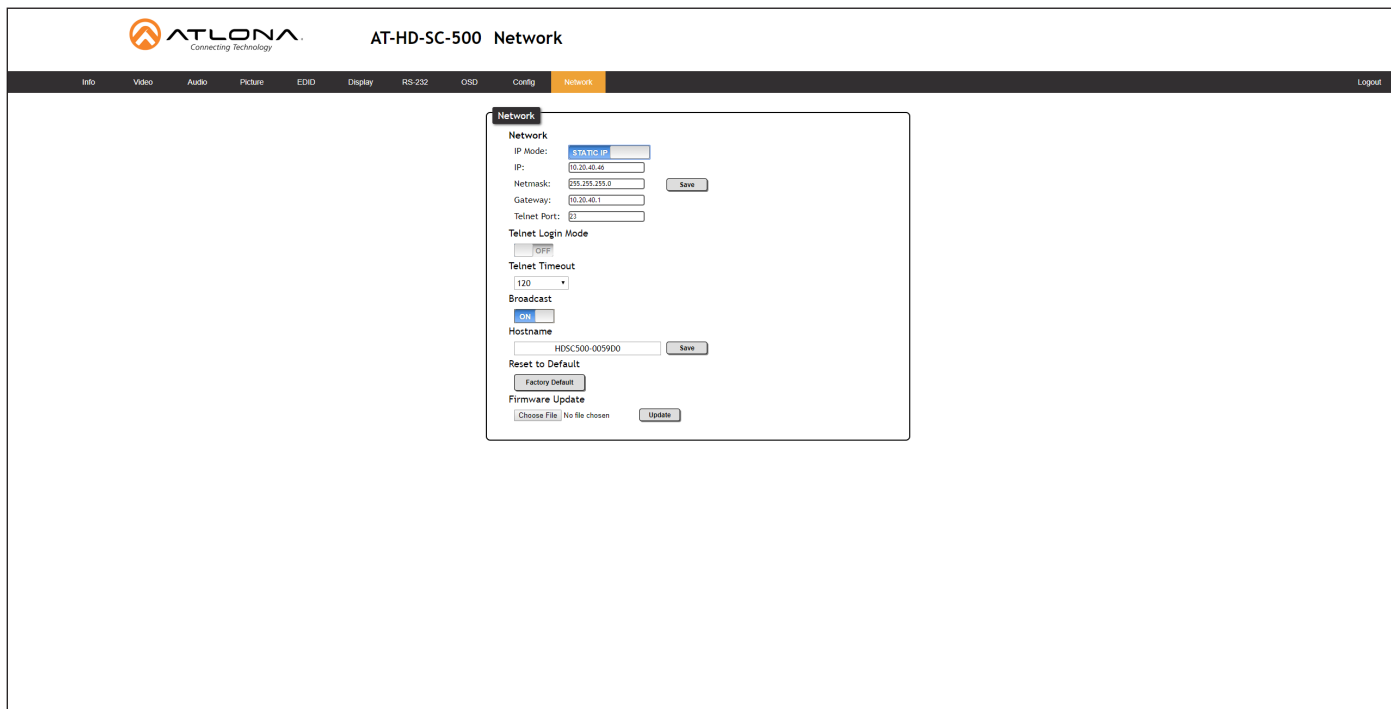

The screenshot shows the AT-HD-SC-500 Network configuration interface. The 'Network' tab is active, displaying the following settings:

- IP Mode:** Static IP
- IP:** 02.30.40.46
- Netmask:** 255.255.255.0
- Gateway:** 02.30.40.1
- Telnet Port:** 23
- Telnet Login Mode:** OFF
- Telnet Timeout:** 120
- Broadcast:** ON
- Hostname:** HDSC500-005900

Buttons for 'Save', 'Reset to Default', and 'Firmware Update' are visible at the bottom of the configuration panel.

#### IP Mode

Click this toggle to set the IP mode of the AT-HD-SC-500. By default, the AT-HD-SC-500 is set to DHCP mode.

#### IP

Enter the IP address of the AT-HD-SC-500 in this field. This field will only be available if **IP Mode** is set to **STATIC IP**.

#### Netmask

Enter the subnet mask in this field. This field will only be available if **IP Mode** is set to STATIC IP.

#### Gateway

Enter the gateway (router) address in this field. This field will only be available if **IP Mode** is set to STATIC IP.

#### Telnet Port

Enter the Telnet port in this field.

#### Telnet Login Mode

Click this toggle to set the login mode to ON or OFF. If this feature is set to on, then the AT-HD-SC-500 will prompt for both the username and password. Use the same credentials as the web GUI.

#### Telnet Timeout

Click this drop-down list to select the timeout interval, in seconds, before the Telnet connection is automatically closed after no activity.

#### Broadcast

Enables or disables broadcast mode. When set to on, any state change to the AT-HD-SC-500 will be reflected through RS-232, Telnet, and TCP port 9000. State changes can be caused by modification of the web UI, physical connection/disconnection of source/sink and additional Telnet/TCP clients making changes. on = broadcast enabled; off = broadcast disabled; sta = displays the current setting. The default setting is on.

#### Hostname

Displays the hostname of the AT-HD-SC-500, as it would appear on a network. To change the hostname, type the new hostname in this field and click the **Save** button.

## Configuration and Management Interfaces

---

**Factory Default**

Sets the AT-HD-SC-500 to factory-default settings.

**Choose File**

Click this button to select the firmware file, when upgrading the firmware on the AT-HD-SC-500.

**Save**

Click this button to save all changes to the network settings.

**Update**

Click this button to begin the upgrade procedure. Refer to [Updating the Firmware \(page 55\)](#) for more information.

# Solution Setup and Configuration Guide

The following sections provide step-by-step instructions for the following topics:

- Input Auto-Switching
- Display Control

## Input Auto Switching

The AT-HD-SC-500 provides auto-switching capability, which will automatically switch the input to the most recently-connected or powered source when a source is disconnected. For example, if the connection sequence is **HDMI 2 > HDMI 1 > VGA**, and a source is disconnected from **HDMI 1**, then the AT-HD-SC-500 will automatically switch to the **VGA** port (the last-connected port).

Auto-switching is enabled (On), by default, and can be enabled or disabled through any one of the following methods:

### Using the OSD

Note that the OSD can only be used to enable or disable auto-switching mode. To enable/disable auto-switching, configure the fallback port, and/or the delay before switching occurs, use the web GUI or RS-232. Refer to [Using the Web GUI \(page 48\)](#) or [Using RS-232 \(page 50\)](#) for more information.

1. Connect a display to the AT-HD-SC-500.
2. Press and hold the **DISPLAY** button on the front panel, until the OSD is displayed, then release the **DISPLAY** button.



3. Press the **VOL UP/DN** buttons to select the **Others** menu.

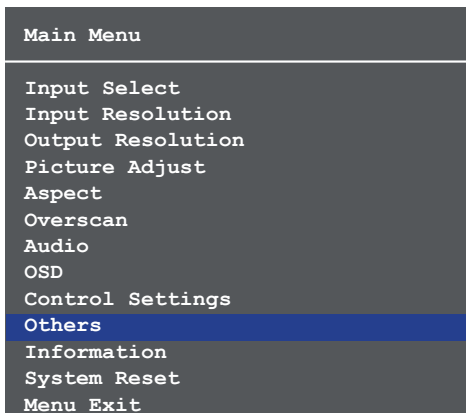

## Solution Setup and Configuration Guide

4. Press and release the **DISPLAY** button. The **Others** menu will be displayed.

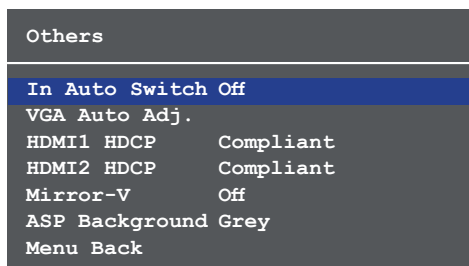

5. Press the **VOL UP/DN** buttons to select the **In Auto Switch** option.
6. Press and release the **DISPLAY** button. The **In Auto Switch** option will be highlighted in green, indicating that the value can be changed.

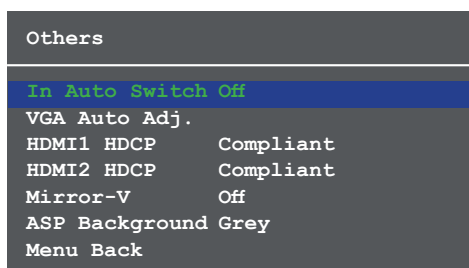

7. Press the **VOL UP/DN** buttons to switch the value to **Off** or **On**.

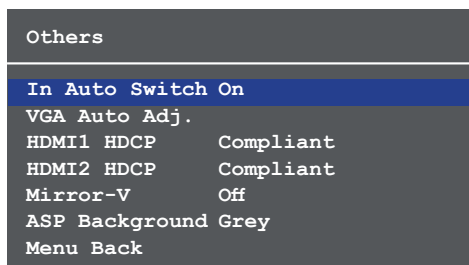

8. Press the **DISPLAY** button to confirm the setting. Note that if the auto-switching fallback port and fallback time need to be adjusted, refer to the web GUI instructions, below.
9. To exit the OSD, press the **VOL UP/DN** button to select **Menu Back** and press the **DISPLAY** button. From the **Main Menu**, press the **VOL UP/DN** button to select **Menu Exit** and press the **DISPLAY** button.

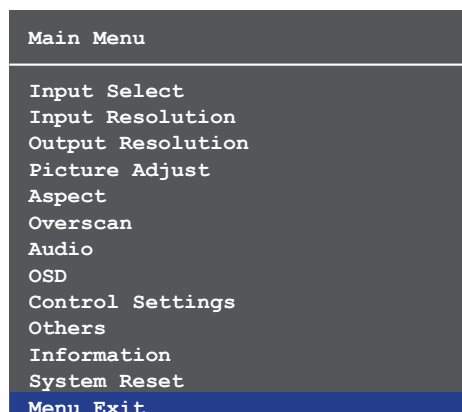
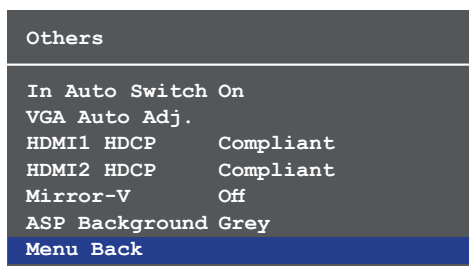

### Using the Web GUI

Refer to [The Web GUI \(page 30\)](#) for more information if necessary.

1. Launch a web browser.
2. In the address bar, type the IP address of the AT-HD-SC-500.



3. Enter the login credentials and click the **Submit** button. The default credentials are listed below:

Username:            root  
 Password:           Atlona

4. Click the **Submit** button or press the [ENTER] key.
5. Click **Video** in the menu bar. The **Video** page will be displayed.

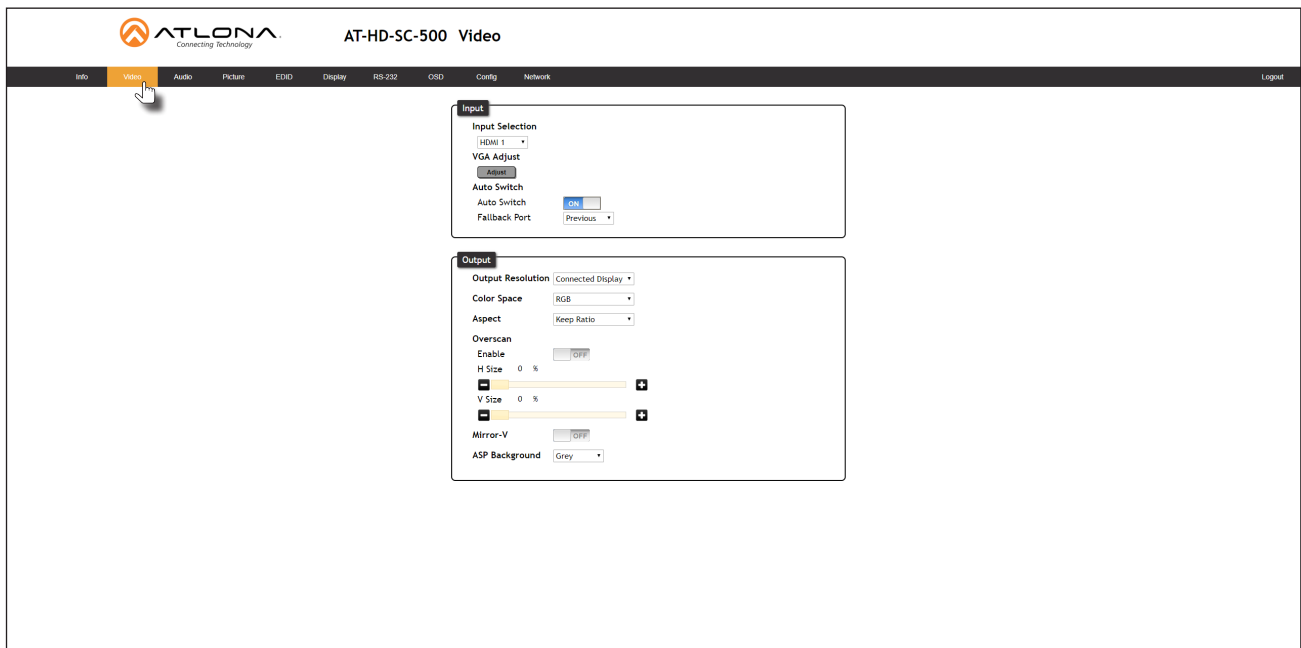



## Solution Setup and Configuration Guide

- Click the **Auto Switch mode** toggle button to enable (ON) or disable (OFF) auto-switching.

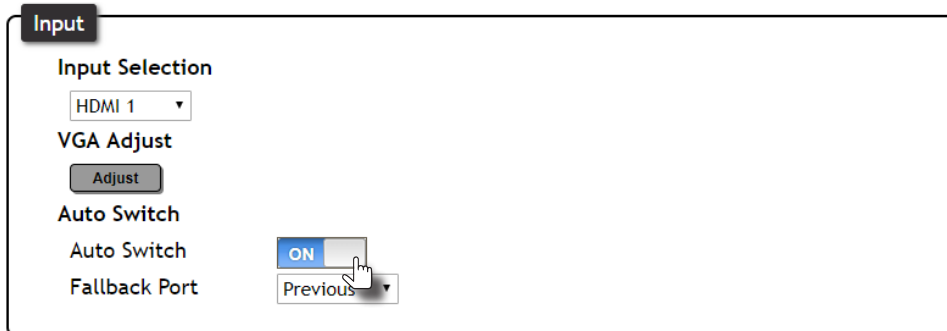

- Click the **Fallback Port** drop-down list to select the desired mode of operation.



Fallback Port	Description
HDMI 1	Automatically switches to HDMI 1.
HDMI 2	Automatically switches to HDMI 2.
VGA	Automatically switches to VGA.
Previous (default setting)	The switcher will return to the previous (last connected) input. If no input is found, then it will attempt to switch to a ternary port.

- Configuration is complete. Changes are automatically saved.

## Display Control

The AT-HD-SC-500 provides both a **LAN** and **RS-232** port, which allows commands to be sent from the AT-HD-SC-500 to a connected display over a serial cable or over Ethernet. No external control system is required. The **DISPLAY** and **VOL** (up/down) buttons can be programmed to toggle power on the display and/or adjust the output volume of the display (if the display has speakers). This allows for convenient control of the display device from the location of the source device.

### Using RS-232

1. Connect a serial cable from the **RS-232** port on the AT-HD-SC-500, to the RS-232 port on the display. The included 3-pin captive screw connector should be wired as shown. Refer to [RS-232 \(page 11\)](#) for information.

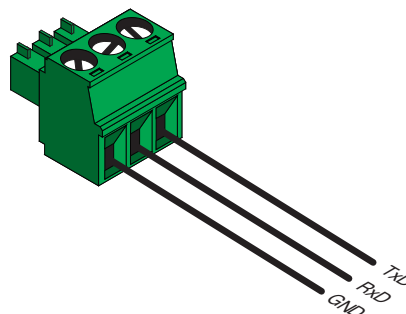
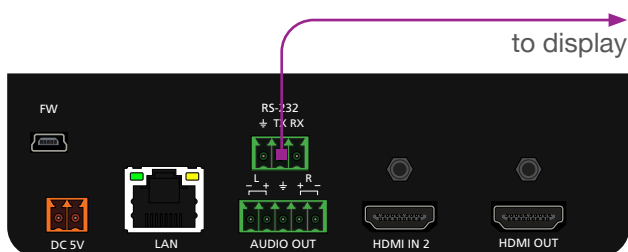

2. Launch a web browser.
3. In the address bar, type the IP address of the AT-HD-SC-500.
4. The **Login** page will be displayed. Enter the required credentials. The default credentials are shown below:

Username: root  
Password: Atlona



5. Click the **Submit** button or press the ENTER key on the keyboard.
6. Click **RS-232** in the menu bar. The **RS-232** page will be shown.

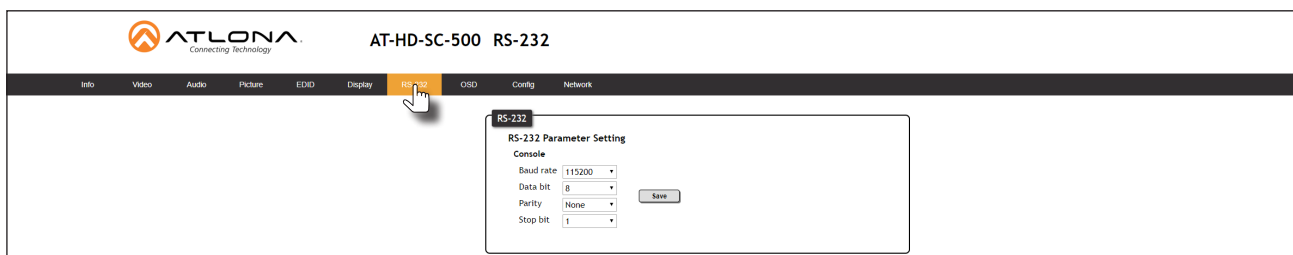

- Set the RS-232 settings for the display (sink) device. These settings must match the device settings for the display. Otherwise, RS-232 control will not function. Refer to the User Manual of the display device for information.
- Click the **Save** button to commit changes.

RS-232

### RS-232 Parameter Setting

**Console**

Baud rate:

Data bit:

Parity:

Stop bit:

- Click **Display** in the menu bar. The **Display** page will be shown.

AT-HD-SC-500 Display

Info Video Audio Picture EDID Display RS-232 OSD Config Network

**CEC**

CEC Command Power

**System Settings**

Display Auto Power On  **ENABLED**

Display Auto Power Off  **DISABLED**

Auto Power Off Timer

Power Button Lock  **DISABLED**

Lamp Cool Down Timer(0-300 Sec.)

Display Warm Up Timer(0-300 Sec.)

Control Type

Display Mode

- Under **System Settings**, click the **Control Type** drop-down list and select **RS-232**.

System Settings

Display Auto Power On  **ENABLED**

Display Auto Power Off  **DISABLED**

Auto Power Off Timer

Power Button Lock  **DISABLED**

Lamp Cool Down Timer(0-300 Sec.)

Display Warm Up Timer(0-300 Sec.)

Control Type

Display Mode

Volume/Mute

- Scroll down to the bottom of the page and locate the **RS-232 / IP commands** section.
- Enter the required command string for the device that is being controlled. Note that not all displays/sink devices use the same codes for each function.

### HEX Command Strings

- Enter the hexadecimal command string in the correct field. An example *power-on* command for a display might be:

```
\xBE\xEF\x03\x06\x00\xBA\xD2\x01\x00\x00\x60\x01\x00\x0D
```

This command would be entered in the **ON** field. Consult the documentation for the display for the correct command strings.

- Make sure the command string is terminated correctly. In most cases, a CR (carriage return) should be specified. In the example above, “\x0D” is the hexadecimal value for a carriage return.

### ASCII Command Strings

- Enter the ASCII command string in the correct field. An example *power-on* command for a display might be:

```
PWON
```

This command would be entered in the **ON** field. Consult the documentation for the display for the correct command strings.

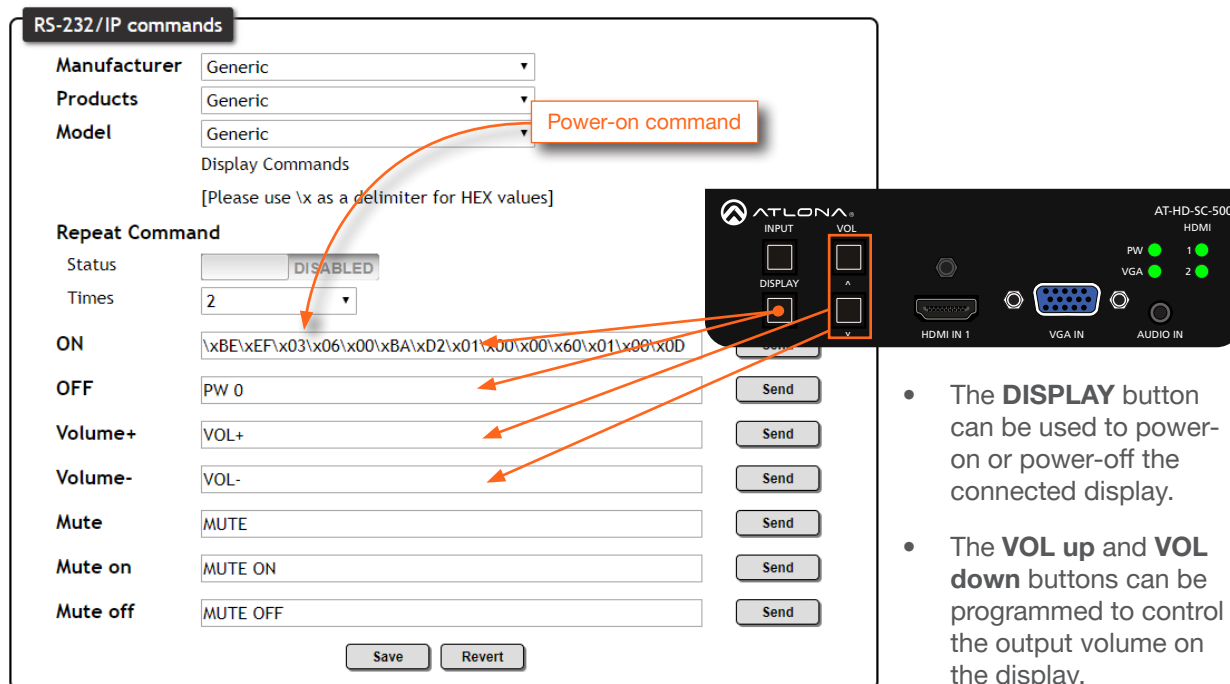

**RS-232/IP commands**

Manufacturer: Generic

Products: Generic

Model: Generic

Display Commands  
[Please use \x as a delimiter for HEX values]

Repeat Command  
Status:   
Times: 2

ON: \xBE\xEF\x03\x06\x00\xBA\xD2\x01\x00\x00\x60\x01\x00\x0D

OFF: PW 0

Volume+: VOL+

Volume-: VOL-

Mute: MUTE

Mute on: MUTE ON

Mute off: MUTE OFF

- The **DISPLAY** button can be used to power-on or power-off the connected display.
- The **VOL up** and **VOL down** buttons can be programmed to control the output volume on the display.

13. Click the **Send** button for each command string to verify that the commands were entered and function correctly.

14. Click the **Save** button to commit the changes.

### Using IP

Instead of using a serial cable to send commands, this method uses an Ethernet cable to send commands from the AT-HD-SC-500 to the display device.

1. Connect an Ethernet cable from the **LAN** port on the AT-HD-SC-500, to the LAN port on the display.

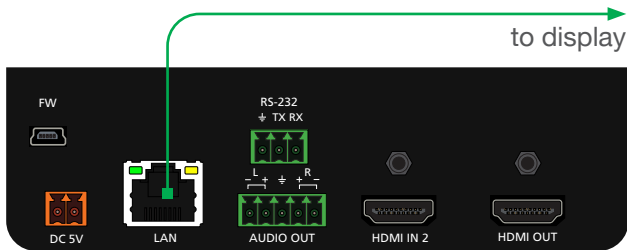

2. Launch a web browser.
3. In the address bar, type the IP address of the AT-HD-SC-500.
4. The **Login** page will be displayed. Enter the required credentials. The default credentials are shown below:

Username: root  
 Password: Atlona



5. Click the **Submit** button or press the ENTER key on the keyboard.
6. Click **Display** in the menu bar. The **Display** page will be shown.

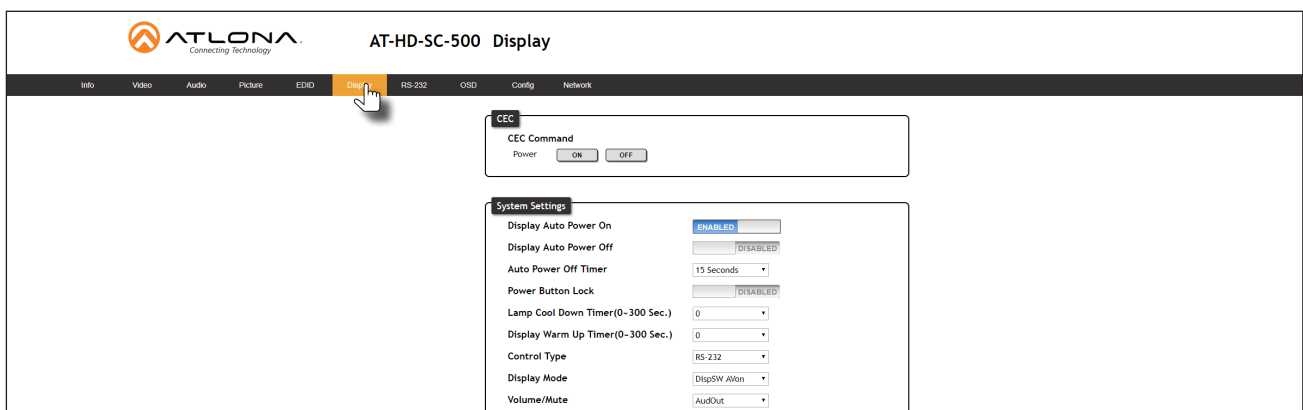

7. Under **System Settings**, click the **Control Type** drop-down list and select **IP**.

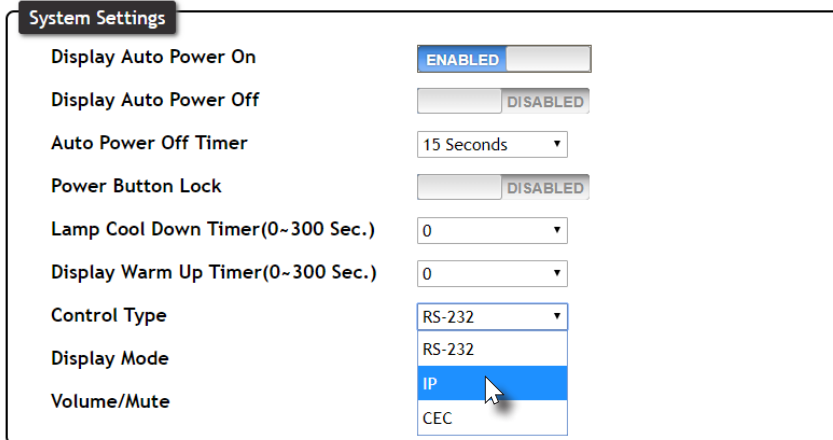

System Settings	
Display Auto Power On	ENABLED
Display Auto Power Off	DISABLED
Auto Power Off Timer	15 Seconds
Power Button Lock	DISABLED
Lamp Cool Down Timer(0-300 Sec.)	0
Display Warm Up Timer(0-300 Sec.)	0
Control Type	RS-232
Display Mode	RS-232
Volume/Mute	IP
	CEC

8. Locate the **TCP/IP Settings of Controlled Device** section and enter the following information:
- IP Mode  
If the device does not require a login, then set this drop-down value to **Non-Login**. If the device requires login credentials, select **Login** from the drop-down list. Note that if **Login** is selected, then the **Username** and **Password** fields will need to be populated with the required login credentials.
  - IP Address  
Enter the IP address of the device to be controlled.
  - Port  
Enter the port in this field.
  - Username  
This field is only required if **IP Mode** is set to **Login**. Enter the username login credential in this field.
  - Password  
This field is only required if **IP Mode** is set to **Login**. Enter the username login credential in this field.
9. Scroll down to the bottom of the page and locate the **RS-232 / IP commands** section.
10. Click the **Send Mode** toggle switch to either **ASCII** or **HEX**, depending on the command format being used. In the example below, a hexadecimal command string will be entered. Therefore, **Send Mode** must be set to **HEX**. Note that commands must be either ASCII or hexadecimal. Mixing both formats is not permitted.
11. Enter the required command string for the device that is being controlled. Note that not all displays/sink devices use the same codes for each function.
12. Follow the steps on page 52 to complete the process.

# Appendix

## Updating the Firmware

Updating the firmware can be completed using either the USB interface or the web GUI. Atlona recommends using the web GUI for updating the firmware. However, if a network connection is not available, the AT-HD-SC-500 firmware can be updated using a USB-A to USB mini-B cable.

### Using the Web GUI

#### Requirements

- AT-HD-SC-500
  - Firmware file
  - Computer
1. Connect an Ethernet cable from the computer, containing the firmware, to the same network where the AT-HD-SC-500 is connected.
  2. Go to the [Network Page \(page 44\)](#) in the web GUI.

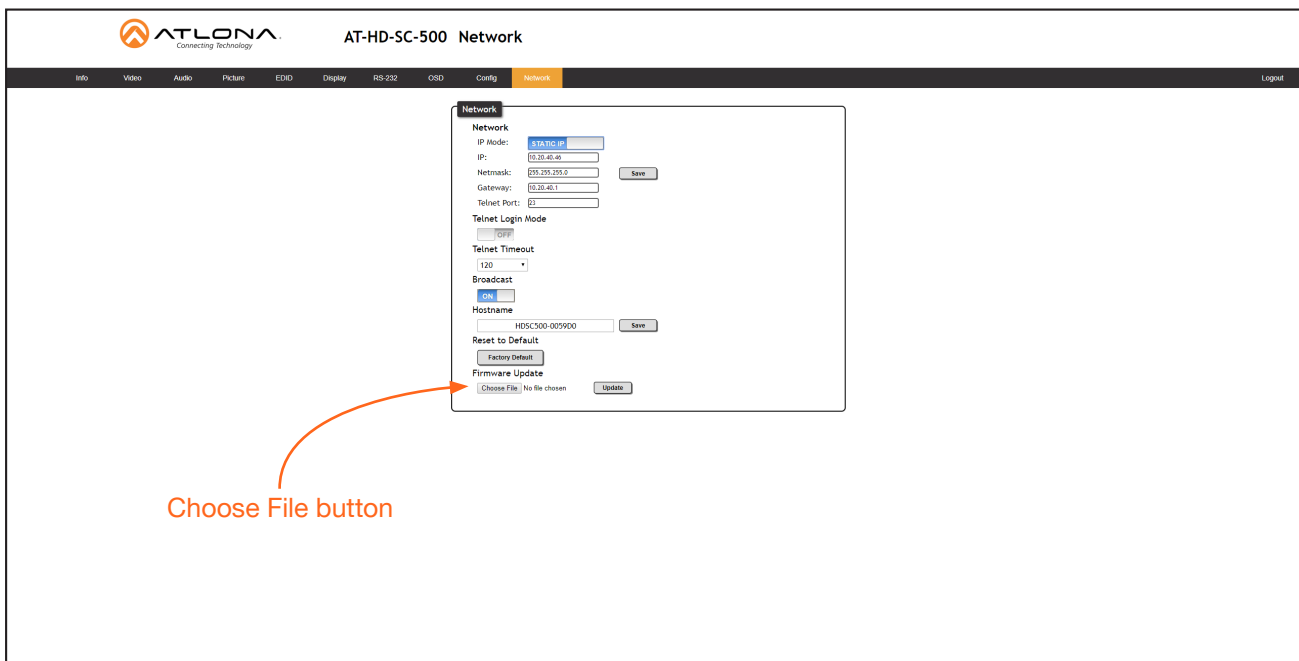

3. Click the **Choose File** button, under the **Firmware Update** section.
4. Browse to the location of the firmware file, select it, and click the **Open** button.
5. Click the **Update** button.
6. The following dialog will be displayed.

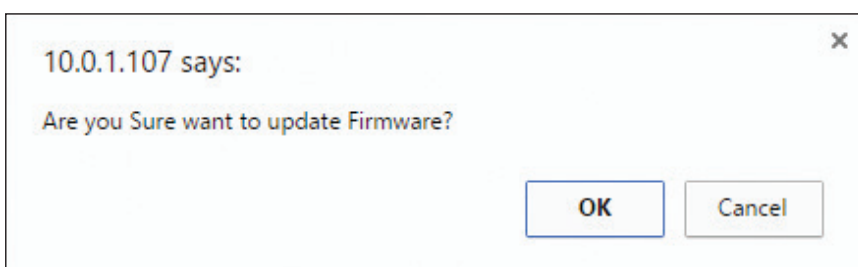

7. Click the **OK** button to begin the firmware update process. Click the **Cancel** button to cancel the process.
8. The update process will take approximately 60 seconds and will automatically reboot the AT-HD-SC-500.
9. After the firmware update process is complete, the **Login** screen will be displayed.



## Using USB

### Requirements

- AT-HD-SC-500
- Firmware file: HDSC-500-FW-[version].BIN
- Computer running Windows
- USB-A to USB mini-B cable

1. Disconnect power from the AT-HD-SC-500.
2. Connect the USB-A to USB mini-B cable from the computer to the **FW** port on the AT-HD-SC-500.



3. Press and hold the **DISPLAY** key, on the front panel, while connecting power to the AT-HD-SC-500.

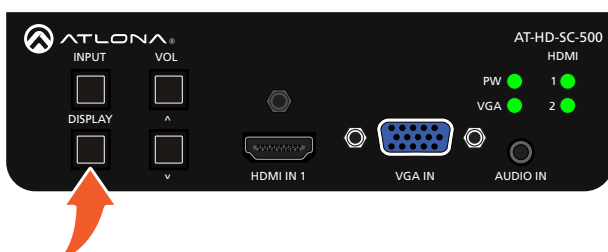



4. The USB UPDATE folder will be displayed.

If this folder is not displayed, automatically, select the USB UPDATE drive from Windows Explorer.

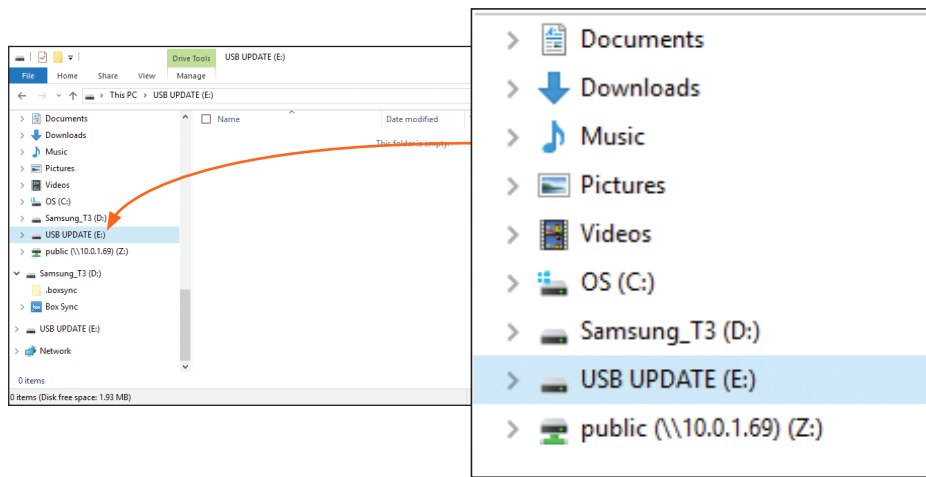

7. Delete all files from the USB UPDATE drive, if any are present.
8. Drag-and-drop the HDSC-500-FW-[version].BIN firmware file to the drive.
9. After the file has been copied, disconnect the USB cable from both the computer and the AT-HD-SC-500.
10. Power-cycle the AT-HD-SC-500 by disconnecting then reconnecting the power supply.
11. The firmware update process is complete.

## Mounting Instructions

The AT-HD-SC-500 includes two mounting brackets, which can be used to attach the unit to any flat surface. Use the enclosure screws, on the sides of the unit to attach the mounting brackets.

1. Using a small Phillips screwdriver, remove the four screws from the left side of the enclosure.

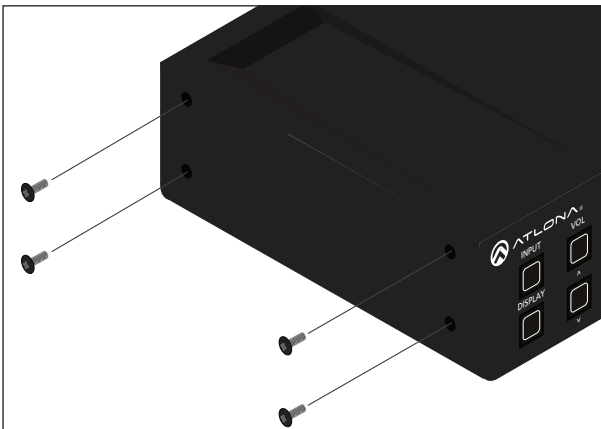

2. Position one of the mounting brackets, as shown below, aligning the holes on the side of the enclosure with one set of holes on the mounting bracket.
3. Repeat steps 1 and 2 to attach the second mounting bracket to the opposite side of the unit.
4. Mount the unit to a flat surface using the oval-shaped holes, on each mounting bracket. If using a drywall surface, a #6 drywall screw is recommended.

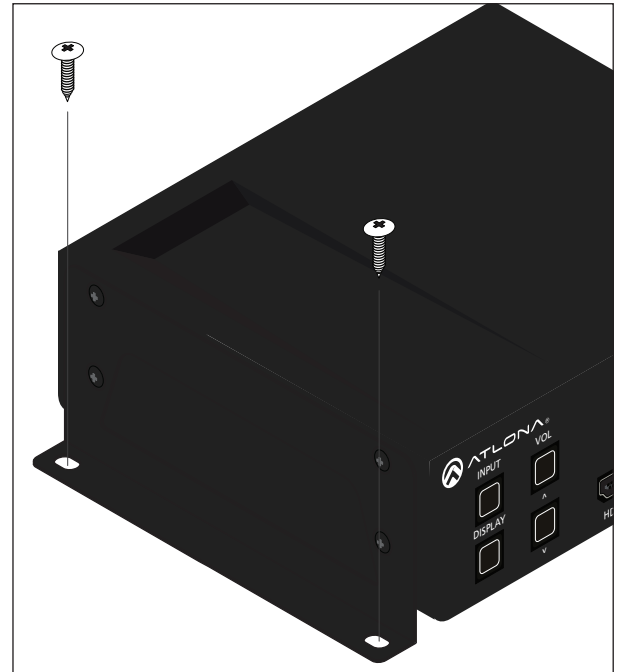

**NOTE:** Mounting brackets can also be inverted to mount the unit under a table or other flat surface.

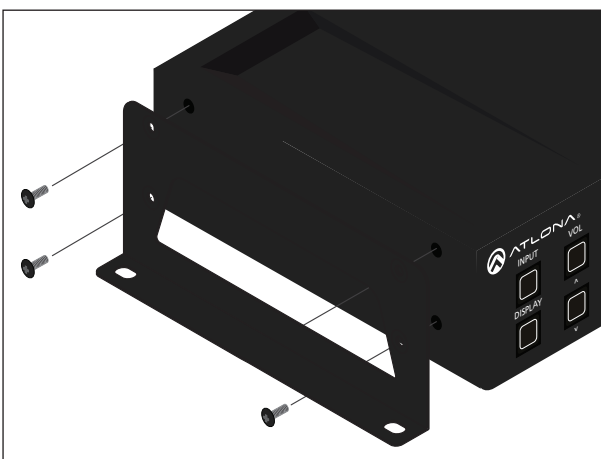

## Default Settings

The following tables list the factory-default settings for the AT-HD-SC-500.

Feature	Settings	
Video	Input Selection	HDMI 1
	Auto Switch mode	ON
	Fallback Port	Previous
	Fallback Time (Sec)	5
	Output Resolution	1280x720p60
	Color Space	RGB
	Aspect	Full
	Overscan	Off
	Mirror-V	Off
	ASP Background	Grey
Audio	HDMI 1	Auto
	HDMI 2	Auto
	Mute	OFF
	HDMI Audio	On
	L/R Audio	On
	Output Volume	-10
	Output Bass	0
	Output Treble	0
Picture	Brightness	64
	Contrast	64
	Saturation	64
	Hue	64
	Sharpness	32
EDID	HDMI Preferred Timing	1280x800
	VGA Preferred Timing	1280x800
	HDMI1 HDCP	compliant
	HDMI2 HDCP	compliant
Display	Display Power On	DISABLED
	Display Power Off	DISABLED
	Power Button Lock	DISABLED
	Lamp cool down timer (sec)	0
	Display Warm Up Timer (sec)	0
	Auto Power Off Timer (sec)	15
	Control Type	RS-232
	Feedback Verify	OFF
	Display Mode	DispSW AVon
	Volume / Mute	AudOut
	IP Mode	Non-Login
	IP Address	0.0.0.0
	Port	23
	Username	root
	Password	Atlona
	Send Mode	ASCII

Feature	Settings	
System	IP Mode	DHCP
	Static IP Address (default)	192.168.1.254
	Netmask	255.255.255.0
	Gateway	192.168.1.1
	Telnet Port	23
	Telnet Login Mode	Off
	Telnet Timeout	120 (seconds)
	Broadcast	On
RS-232	Baud Rate	115200
	Data Bit	8
	Parity	None
	Stop bit	1
OSD	Position	Left-Top
	Transparency	12
	Info. Timer	10
	Menu Timer	20
	Info. Display	Auto
	Background	Grey
Network	IP Mode	DHCP
	IP	assigned by DHCP server
	Netmask	255.255.255.0
	Gateway	assigned by DHCP server
	Telnet Port	23
	Telnet Login Mode	Off
	Telnet Timeout	120
	Broadcast	On

## Specifications

Video	
HD/SD Resolutions (input)	1080p@23.98/24/25/29.97/30/50/59.94/60Hz, 1080i@50/59.94/60Hz, 720p@50/59.94/60Hz, 576p, 576i, 480p, 480i, 1920×1200, 1680×1050, 1600×1200, 1600×900, 1440×900, 1400×1050, 1366×768, 1360×768, 1280×1024, 1280×800, 1280×768, 1152×864, 1024×768, 800×600, 640×480
HD/SD Resolutions (output)	1080p@23.98/24/25/29.97/30/50/59.94/60Hz, 1080i@50/59.94/60, 720p@25/29.97/30/50/59.94/60, 1920×1200, 1680×1050, 1600×1200, 1600×900, 1400×1050, 1366×768, 1280×1024, 1280×800, 1024×768, 800×600
Color Space	YUV, RGB
Chroma Subsampling	4:4:4, 4:2:2
Color Depth	8-bit, 10-bit, 12-bit

Audio	
Analog In	3.5mm stereo jack, -10 dBu nominal input
Analog Out	Balanced, +4 dBu nominal analog output. Max output +18 dBu (only from 2Ch PCM sources)
HDMI IN / OUT	PCM 2Ch, LPCM 5.1, LPCM 7.1, Dolby® Digital, Dolby Digital Plus, Dolby TrueHD, DTS® 5.1, DTS-HD Master Audio™, DTS:X™, Dolby Atmos®
Sample Rate	32 kHz, 44.1 kHz, 48 kHz, 88.2 kHz, 96 kHz, 176.4 kHz, 192 kHz
Bit Rate	24-bit (max.)

Resolution / Distance	Feet	Meters
HDMI IN/OUT @ 1080p	30	10

Signal	
Bandwidth	6.75 Gbps
CEC	Yes
HDCP	Switchable – Compliant/Non-compliant

Temperature	Fahrenheit	Celsius
Operating	32 to 122	0 to 50
Storage	-4 to 140	-20 to 60
Humidity (RH)	20% to 90%, non-condensing	

Power	
Consumption	10.4 W
Supply	Input: 100 - 240 V AC, 50/60 Hz Output: 5 V DC, 3.6 A

Dimensions	Inches	Millimeters
H x W x D	1.5 x 5 x 4.02	38 x 127 x 102

Weight	Pounds	Kilograms
Unit	0.60	0.27

Certification	
Power Supply	CE, TUV, RCM, RoHS, FCC
Product	CE, FCC

# Index

---

- A**
  - Analog audio**
    - passing* 17
  - Aspect ratio** 21, 35
  - Audio**
    - embedding* 23
    - muting* 36
    - passing analog audio* 17
    - settings* 22
  - Auto-switching**
    - using the OSD* 48
    - using the web GUI* 50
- B**
  - Bass**
    - adjusting* 36
  - Brightness** 20, 37
- C**
  - CEC**
    - compatibility* 3, 26
  - Color space** 20, 35
  - Configuration**
    - IP. See IP configuration*
  - Connection**
    - diagram* 11
    - instructions* 11
  - Contents**
    - package* 9
  - Contrast** 20, 37
  - Customer support** 3
- D**
  - Default settings** 62
  - DHCP** 30, 46
  - Display control**
    - using IP* 55
    - using RS-232* 52
- F**
  - FCC statement** 6
  - Features** 9
  - Firmware**
    - updating* 58
- G**
  - Gateway** 46
- H**
  - HDCP**
    - settings* 38
  - Hue** 20, 37
- I**
  - Information**
    - displaying* 29
  - Input**
    - selecting* 16, 19
  - Installation** 11
  - IP address**
    - default* 30
  - IP configuration**
    - using commands* 14
    - using the front panel* 14
    - using the web GUI* 15
- M**
  - Mounting instructions** 61
  - Muting**
    - audio* 36
- O**
  - Operating notes** 3
  - OSD**
    - displaying* 18
    - settings* 24
  - Overscan**
    - adjusting* 22, 35
- P**
  - Password**
    - setting* 45
  - Perferred timing**
    - HDMI* 38
  - Picture**
    - settings* 20
  - Power**
    - connector* 11
  - Preferred timing**
    - VGA* 38
- R**
  - Reset**
    - factory-default* 46
  - Resolution**
    - input* 19
    - output* 20, 35
- RS-232**
  - baud rate* 43
  - data bits* 43
  - parity bit* 43
  - stop bit* 43
- S**
  - Safety information** 6
  - Saturation** 20, 37
  - Sharpness** 37
  - Specifications** 64
  - Static IP** 30, 46
  - Subnet mask** 46
  - Switching**
    - auto* 34, 48
- T**
  - Telnet**
    - listening port* 46
    - login mode* 46
    - timeout* 46
  - Timer**
    - auto power-off* 40
    - display warm-up* 40
    - lamp cool down* 40
  - Treble**
    - adjusting* 36
- U**
  - Users**
    - adding* 45
    - editing* 45
    - removing* 45
- V**
  - VGA**
    - signal adjustment* 34
  - Volume**
    - output, adjusting* 36
- W**
  - Warranty** 4
  - Web GUI** 30

