

heavy|mate® - C146 Housings Hood, without stud

Part No. C146 21R010 500 4

Series Heavy duty connectors heavy|mate® - C 146

Subseries Heavy duty connector heavy|mate® - C146 Housings



COMMON CHARACTERISTICS		
Cable entry		Side
IP degree of protection		IP 65
Thread		M 25
Version		low profile
Housing type		Hood
Insert type		Hood
Protective cover		PA
ELECTRICAL CHARACTERISTICS		
Contact resistance	DIN EN 60512-2-1, Test 2a / IEC 60512-2-1, Test 2a	0 m
CLIMATICAL CHARACTERISTICS		
Temperature range		- 40 °C / + 100 °C
Upper temperature		+ 100 °C / 1000 h
Lower temperatur		- 40 °C / 16 h
MECHANICAL CHARACTERISTICS		
Mechanical lifetime (standard)		IEC 60512-5; Test 9 a
MATERIALS		
Gasket		NBR
Dielectric material		special surface

heavy|mate® - C146 Housings Hood, without stud

Part No. C146 21R010 500 4

Series Heavy duty connectors heavy|mate® - C 146

Subseries Heavy duty connector heavy|mate® - C146 Housings

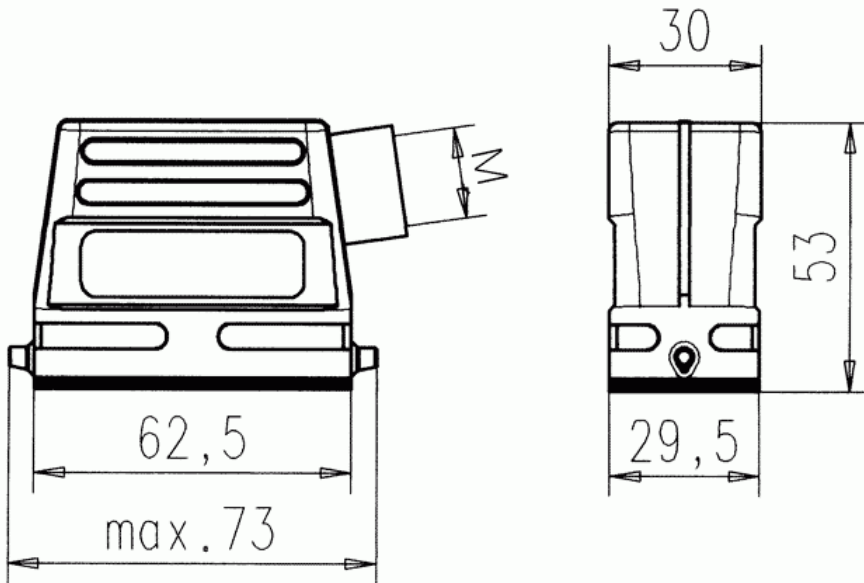

Drawing Dimensions in mm (Inch)

22.05.2007