

Introduction

Welcome	2
AdderLink XDI50FX features	3
Supplied items	4
Optional extras.....	5

Installation

Locations	6
Connections	6
Fiber optic link.....	7
Transmitter video link	8
Transmitter audio links	8
Transmitter USB link	9
Transmitter serial link.....	9
Transmitter management port link	10
Transmitter power connection	11
Receiver video display	12
EDID management.....	12
Receiver audio devices.....	12
Receiver USB devices.....	13
Receiver serial link.....	13
Receiver power connection.....	14

Configuration

Accessing the management application	15
The Configure page	16
The Maintenance page	17

Operation

Indicators	18
Resetting a module	19

Further information

Getting assistance	20
Appendix 1 - Options port pin-out	21
Appendix 2 - Open source licenses.....	22

Index

Introduction

WELCOME

Thank you for choosing the AdderLink XD150FX extender modules. Using fiber optic links, these compact modules allow you to transfer the multiple connections listed below up to 4 kilometers from a host computer (see *Transmission distances* on the right).

The high grade screening employed within the metal cased enclosures combined with the immunity from interference of the fiber optic links make the AdderLink XD150FX modules highly suitable for use in 'noisy' industrial environments.

AdderLink XD150FX extender modules provide support for:

- High quality single- or dual-link DVI digital video (up to 2560 x 2048 @60Hz),
- USB keyboard and mouse plus two other USB devices (up to USB 2.0),
- An RS232 serial device at speeds up to 115200 baud,
- Mono microphone,
- Stereo speakers,
- Line-level audio in/out connections.

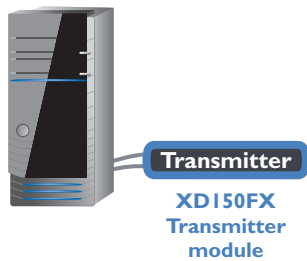

The AdderLink XD150FX extender modules are totally transparent in operation, leaving you free to use your computer as though you're still sitting next to it.

Fiber optic link
(up to 4km)

Transmission distances

The choice of fiber used with the AdderLink XD150FX modules has a considerable effect on the distance over which operation can take place. Using multi-mode fiber you can achieve distances up to 400m (1,312 feet); whereas, by using single-mode fiber (and accompanying SFP modules), the achievable maximum distance is increased to 4km (2.5 miles):

Distance	Fiber type	Fiber color code	SFP module
70m	OM1 (TIA-492AAAA)	Orange	SFP-MM-LC-10G
150m	OM2 (TIA-492AAAB)	Orange	SFP-MM-LC-10G
380m	OM3 (TIA-492AAAC)	Aqua	SFP-MM-LC-10G
400m	OM4 (TIA-492AAAC)	Aqua	SFP-MM-LC-10G
4km	OS1 (TIA-492C000)	Yellow	SFP-SM-LC-10G
	OS2 (TIA-492E000)	Yellow	SFP-SM-LC-10G

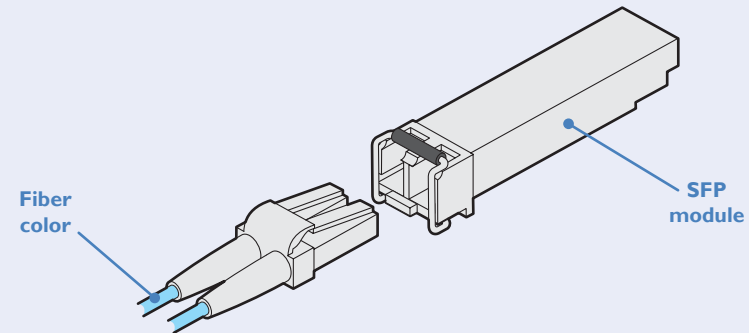

- One dual-link DVI-D display
- Four USB devices
- One RS232 serial device
- Stereo speakers plus microphone

ADDERLINK XD150FX FEATURES

The transmitter and receiver modules are contained within slimline metal casings that measure just 169 x 120 x 31mm.

Transmitter module

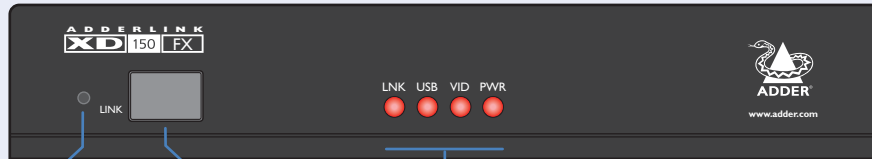

Recessed reset button

See [Resetting a module](#).

SFP slot

Accommodates a fiber optic SFP module of your choice. See [Fiber optic link](#) for further details.

Status indicators

These provide visual confirmation of various system functions. See [Indicators](#) for further details.

Options port

Used for RS232 serial devices. See [Transmitter serial link](#) for further details.

Management port

This Ethernet connection allows remote management of the XD150FX modules. See [Transmitter management port link](#) for further details.

USB port

Connects to a USB port on your computer. See [Transmitter USB link](#) for further details.

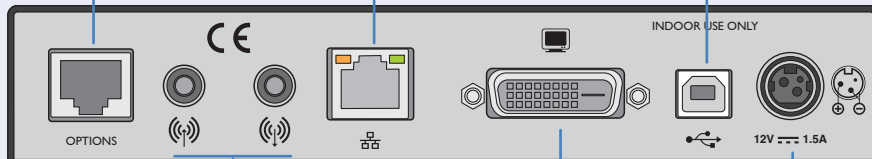

Audio ports

Connects to the audio output/input ports of your computer. See [Transmitter audio links](#) for further details.

Video port

Connects to the DVI-D video output port of your computer. See [Transmitter video link](#) for further details.

Power input

See [Transmitter power connection](#) for further details.

Receiver module

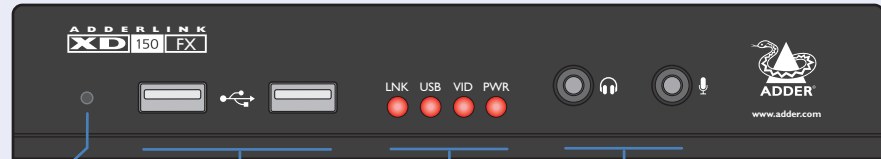

Recessed reset button

See [Resetting a module](#).

USB ports

Connect your USB keyboard, mouse and other devices. See [Receiver USB devices](#) for further details.

Status indicators

These provide visual confirmation of various system functions. See [Indicators](#) for further details.

Audio ports

Connect your microphone and headphones. See [Receiver audio devices](#) for further details.

Audio ports

Connect your microphone and speakers. See [Receiver audio devices](#) for further details.

Video port

Connects to your DVI-D video display. See [Receiver video display](#) for further details.

SFP slot

Accommodates a fiber optic SFP module of your choice. See [Fiber optic link](#) for further details.

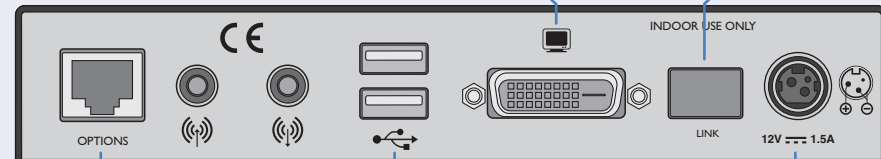

Options port

Used for RS232 serial devices. See [Receiver serial link](#) for further details.

USB ports

Connect your USB keyboard, mouse and other devices. See [Receiver USB devices](#) for further details.

Power input

See [Receiver power connection](#) for further details.

SUPPLIED ITEMS

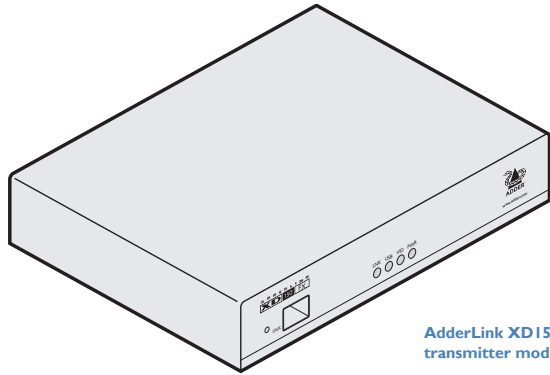

AdderLink XD150FX transmitter module

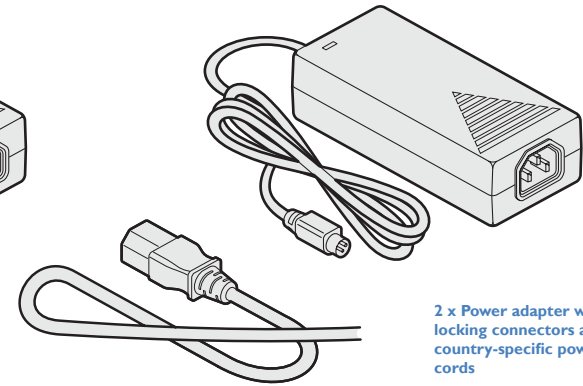
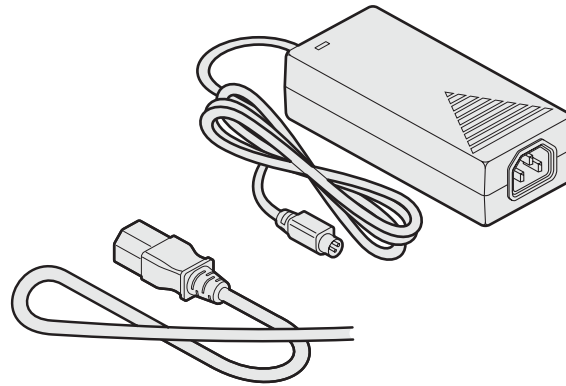

2 x Power adapter with locking connectors and country-specific power cords

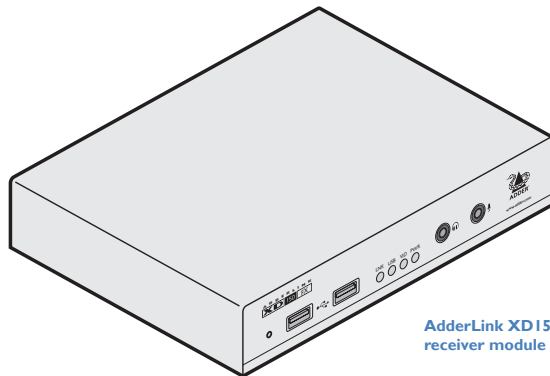

AdderLink XD150FX receiver module

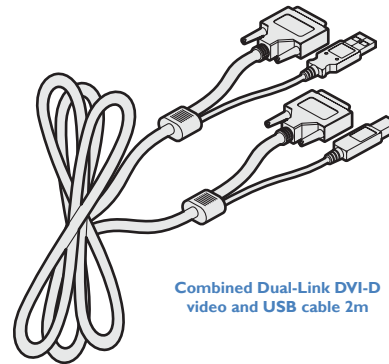

Combined Dual-Link DVI-D video and USB cable 2m

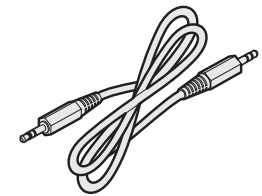
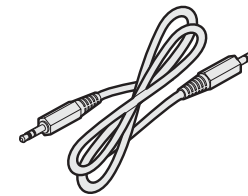

2 x audio cable 3m (3.5mm stereo jacks)

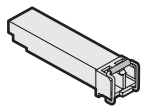

2 x SFP modules with LC connectors (single- or multi-mode)

Either:
Multi mode: SFP-MM-LC-10G
or
Single mode: SFP-SM-LC-10G

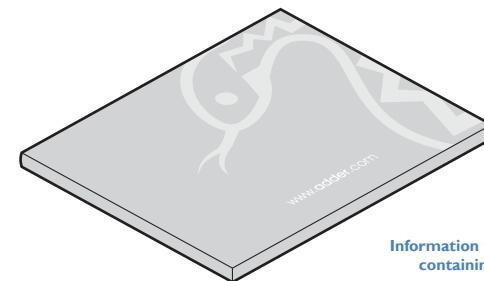

Information wallet containing:
Quick setup guide
Eight self-adhesive rubber feet
Safety document

INSTALLATION

CONFIGURATION

OPERATION

FURTHER INFORMATION

INDEX

OPTIONAL EXTRAS

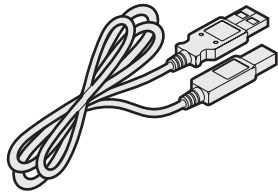

USB cable 2m (type A to B)
Part number: VSC24

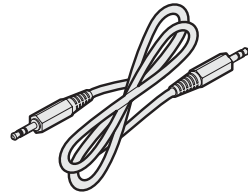

Audio cable 2m (3.5mm stereo jacks)
Part number: VSC22

Replacement power adapter with locking connector
Part number: PSU-IEC-12VDC-1.5A

Country-specific power cords
CAB-IEC-AUS (Australia)
CAB-IEC-EURO (Central Europe)
CAB-IEC-UK (United Kingdom)
CAB-IEC-USA (United States)
CAB-IEC-JAPAN (Japan)

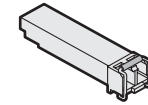
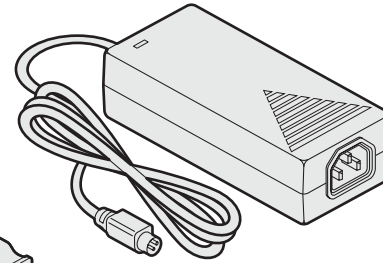

SFP module with LC connectors
Multi mode: SFP-MM-LC-10G
Single mode: SFP-SM-LC-10G

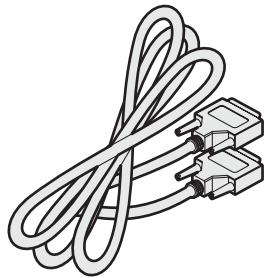

Dual link DVI-D to DVI-D video cable
Part number: VSCDV3

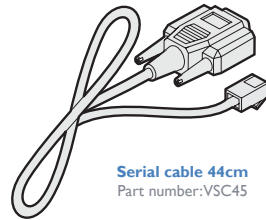

Serial cable 44cm
Part number: VSC45

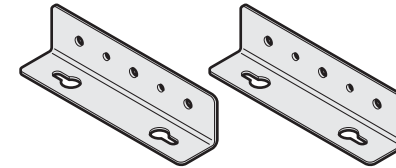
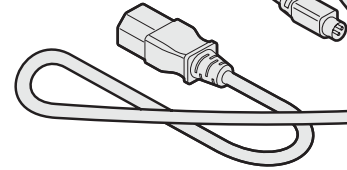

Wall/desk mounting kit (plus screws)
Part number: RMK10

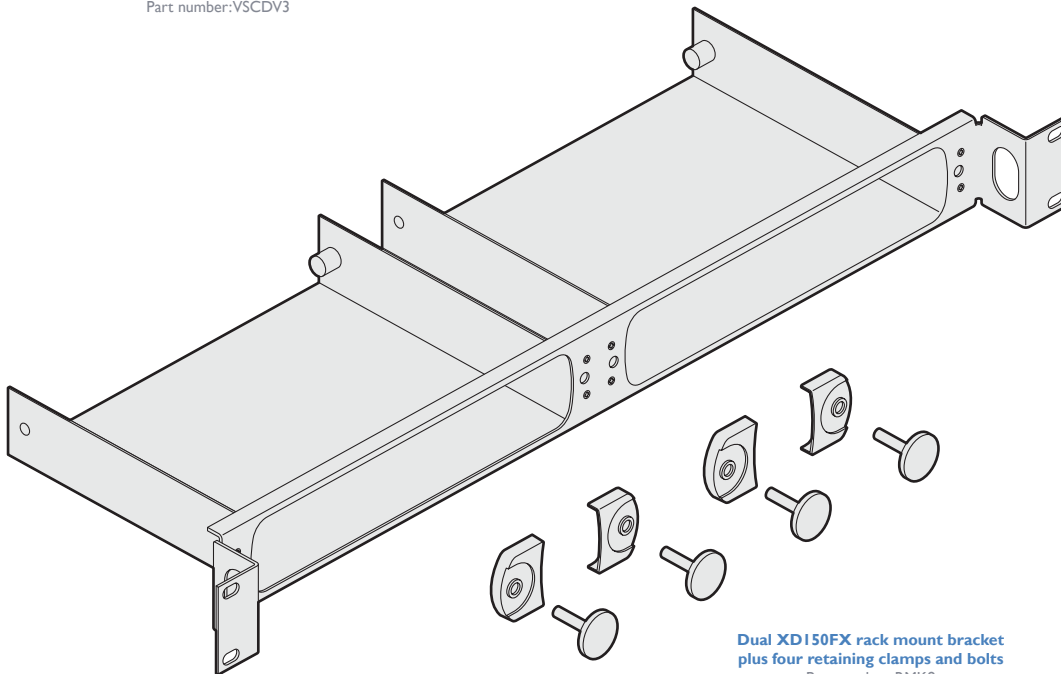

Dual XD150FX rack mount bracket plus four retaining clamps and bolts
Part number: RMK8

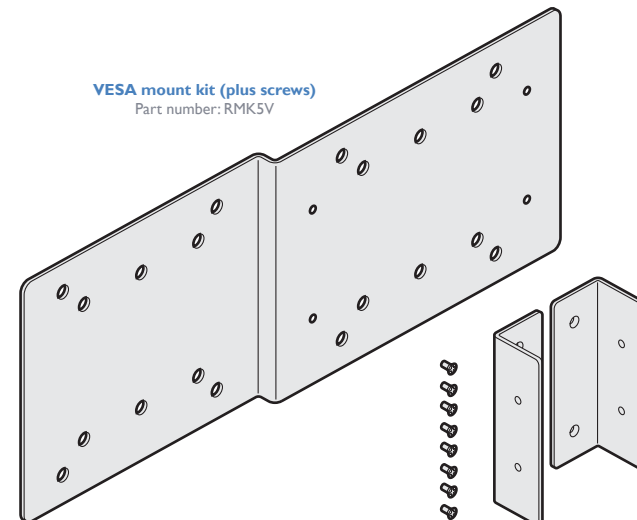

VESA mount kit (plus screws)
Part number: RMK5V

INSTALLATION

CONFIGURATION

OPERATION

FURTHER INFORMATION

INDEX

LOCATIONS

Please consider the following important points when planning the position of the AdderLink XD150FX modules:

- Situate the transmitter module close to the system to which it will be connected and near to a source of mains power. Place the receiver module in similar close proximity to the peripherals that it will connect with, plus a source of mains power.
- Consult the precautions listed within the [Safety information](#) section.
- Connections do not need to be carried out in the order given within this guide, however, where possible connect the *power in* as a final step.

CONNECTIONS

Installation involves linking the AdderLink XD150FX Transmitter module to various ports on the host computer, while the AdderLink XD150FX Receiver module is attached to your peripherals:

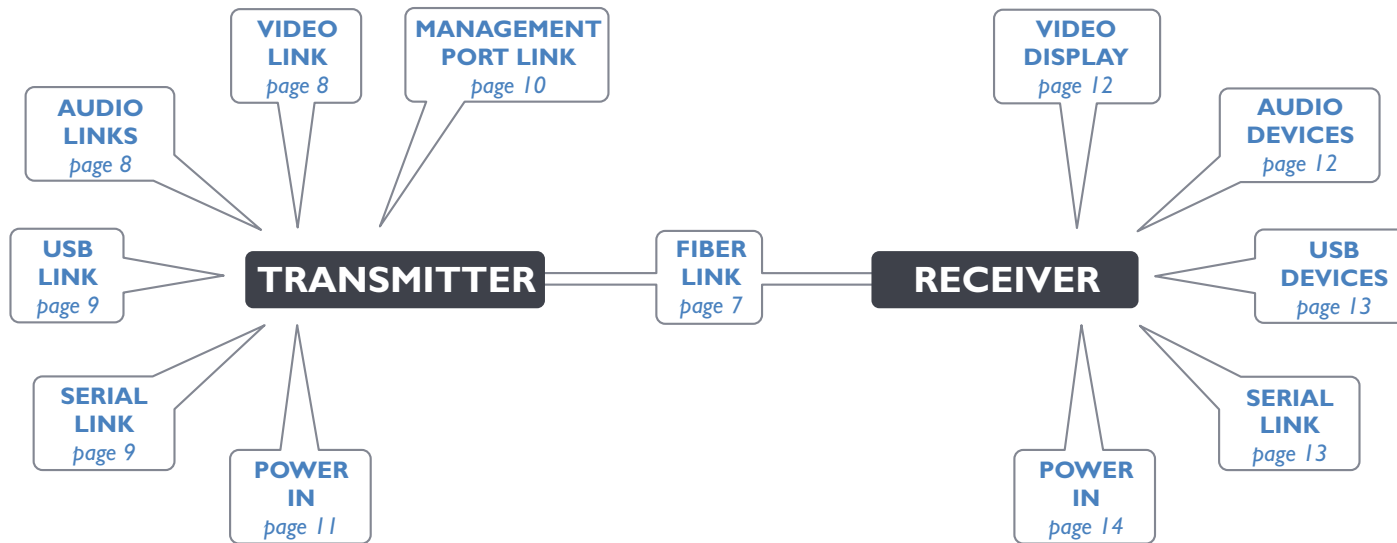

Click a connection to see details

Fiber optic link

Each pair of AdderLink XD150FX modules are supplied together with SFP fiber optic modules of your choice (single or multi-mode). The fiber optic cable used must match the SFP type and also be of a suitable type for the distance being covered. See [Transmission distances](#) for details.

To make the fiber optic link

IMPORTANT: Ensure the power supply is off/disconnected before inserting or removing an SFP module.

- 1 Remove the SFP module from its protective packing and insert it fully into the empty slot on the AdderLink XD150FX. The XD150FX transmitter slot is located on the front panel; the XD150FX receiver slot is situated on the rear panel.

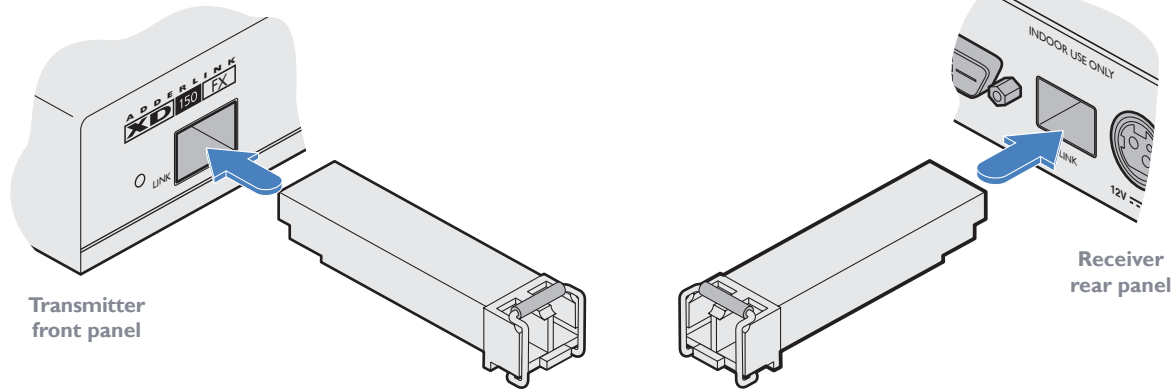

- 2 Repeat for the other SFP module on the other XD150FX.
- 3 For each SFP module, remove the black rubber insert that protects the sensors.
- 4 If fitted, remove the dual inserts that protect the fiber optic connector.
- 5 Insert the fiber optic connector into the SFP module so that it clicks into place.

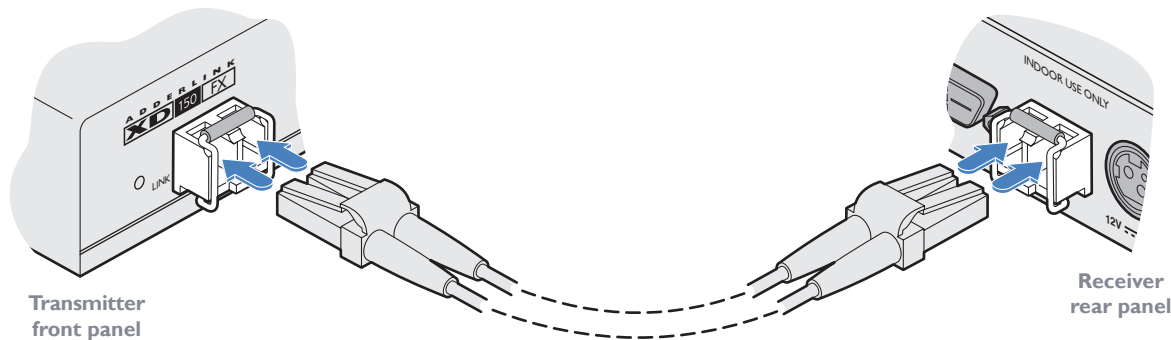

- 6 Repeat steps 4 and 5 at the other end.

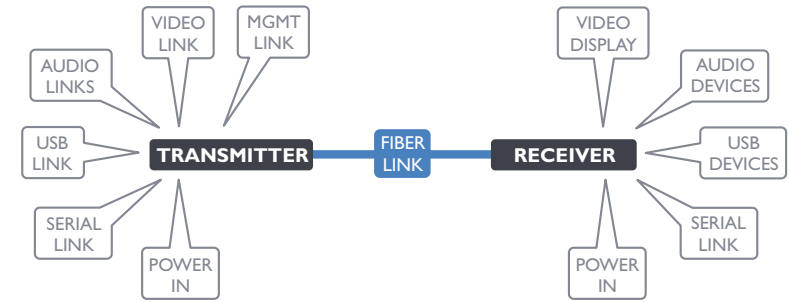

Note: In order to maintain a high level of confidence in the fiber optic link, the SFP's used must be those supplied by Adder: (SFP-MM-LC-10G or SFP-SM-LC-10G).

If alternative parts are used, the system will detect this and will flash the front panel LNK indicator.

To remove an SFP module

- 1 If fitted, remove the fiber optic connector from the SFP module (press down on the upper tab of the fiber optic connector to release it).
- 2 Unclip the small wire extraction lever and open it out (this action releases a locking tab and also provides a grip point).

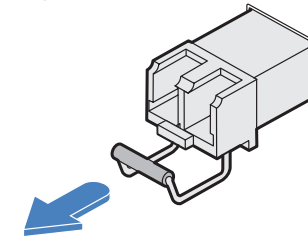

- 3 Gently pull on the extraction lever to withdraw the SFP module from the slot.
- 4 If the SFP module and/or fiber optic connector will remain unused for any period of time, be sure to fit the protective inserts to keep the optical interfaces clean.

Transmitter video link

AdderLink XD150FX can support various high resolution video modes via the Dual-Link DVI-D port, see *Video resolutions* below for details.

To connect the video port

- 1 Connect the supplied digital video (plus USB) link cable between the DVI-D socket on the transmitter module rear panel and the DVI-D video output socket of the host computer.

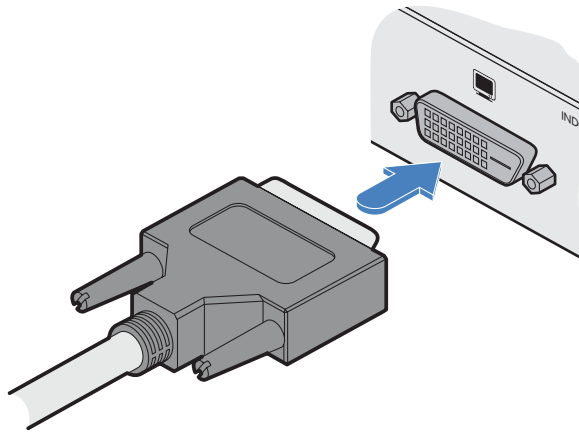
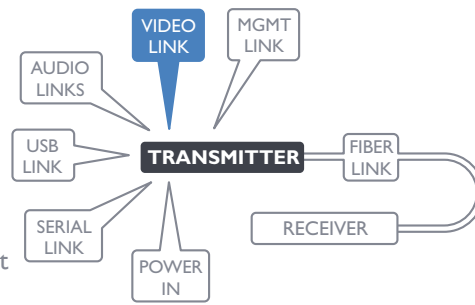

From video output port on the host computer

Video resolutions

The XD150FX supports, but is not limited to, the following common video resolutions:

- 1920 × 1080 (HD)
- 1920 × 1200 (WUXGA)
- 2560 × 1080
- 2560 × 1440 (WQHD)
- 2560 × 1600 (WQXGA)
- 2560 × 2048 (QSXGA)
- 2048 × 2160

Transmitter audio links

The AdderLink XD150FX modules support stereo audio in and out connections. Where necessary, make connections between the audio input and/or output ports of the host computer and the transmitter module.

To connect the audio ports

- 1 For the line in and/or line out ports, connect the supplied audio link cable between the audio input on the transmitter module rear panel and the line in or line out socket of the host computer.

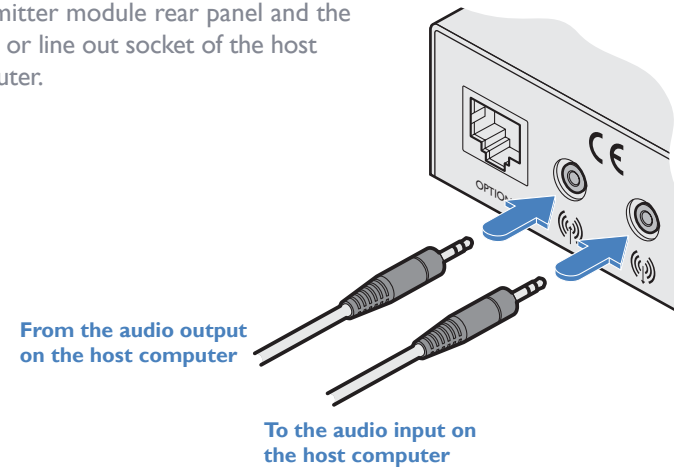
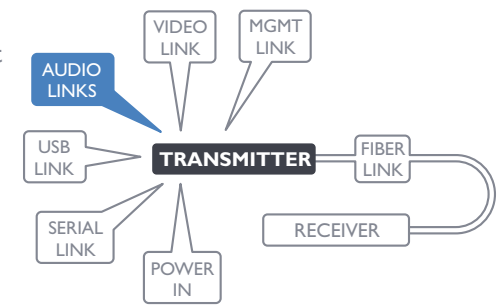

Transmitter USB link

The transmitter module requires a single USB connection to the host computer; this allows the receiver module to operate as a USB 2.0 hub with four ports.

To connect the USB port

- 1 Connect the type B connector of the supplied USB/video cable to the USB port on the rear panel of the transmitter module.

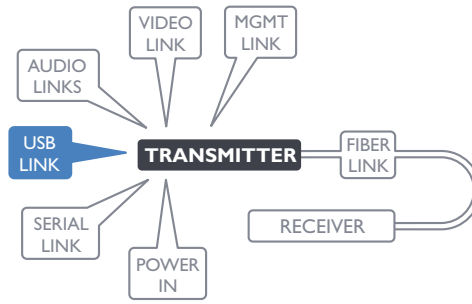

USB link from the host computer

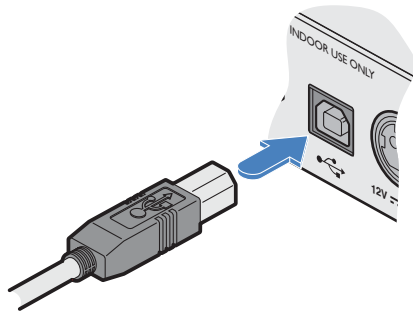

- 2 Connect the type A connector of the cable to a vacant USB port on the host computer.

Transmitter serial link

The Options port provides an RS232 serial connection with the receiver module. When serial devices are attached to the Options ports on the transmitter and receiver modules, the units transparently convey the signals between them, via the fiber optic link, at rates up to 115200 baud - no serial configuration is required. An optional serial cable (part number:VSC45) is available from Adder.

To connect the serial port

- 1 Use the optional serial cable (VSC45) to link the Options port on the rear panel of the transmitter module with a vacant RS232 serial port on your host computer.

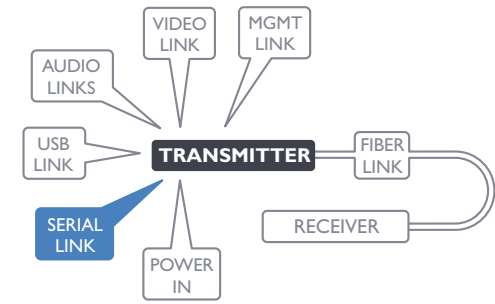

From the serial port of your host computer

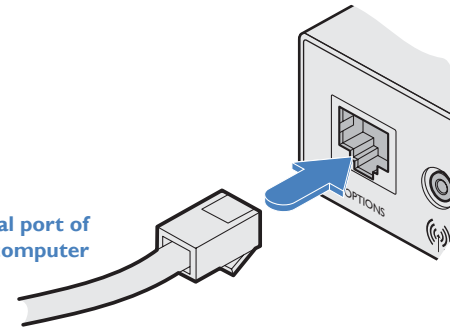

Please see [Appendix I](#) for pin-out details of the Options port.

Transmitter management port link

The management port, located on the transmitter, allows the module to be connected to a standard Ethernet 10/100 network in order to allow remote monitoring and management functions to take place.

To connect the management port

- 1 Connect a standard CATx patch lead between the port on the rear panel of the transmitter module and a standard network switch.

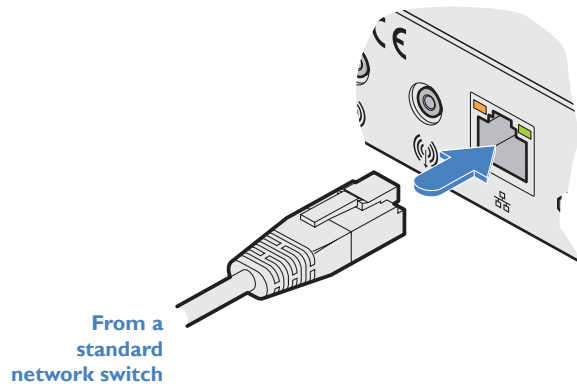
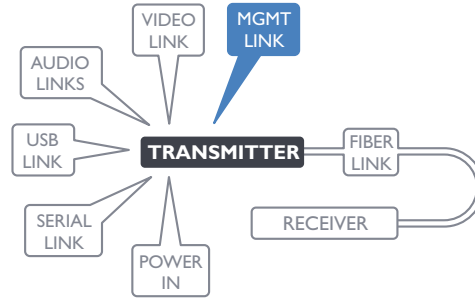

By default, the IP address is set to **192.168.1.22**. If required, you can change the default IP address or alternatively, choose automated address selection by DHCP server. For details, please see the Configuration section.

Transmitter power connection

There is no on/off switch on either of the AdderLink XD150FX modules, so operation begins as soon as power is applied. The power adapters supplied with the modules use locking-type plugs to help prevent accidental disconnections; please follow the instructions shown on the right whenever disconnecting a power adapter.

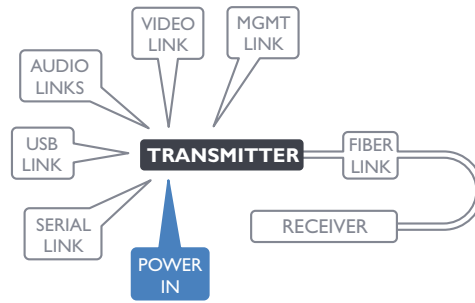

To connect the power adapter

- 1 Attach the output plug of the supplied power adapter to the power input socket on the right side of the rear panel.

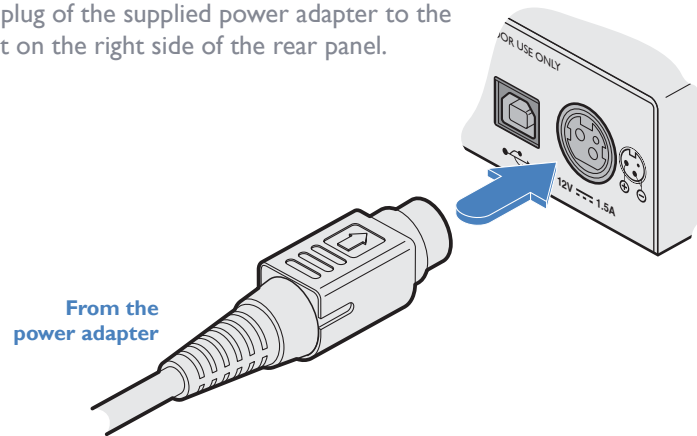

- 2 Connect the IEC connector of the supplied country-specific power cord to the socket of the power adapter.

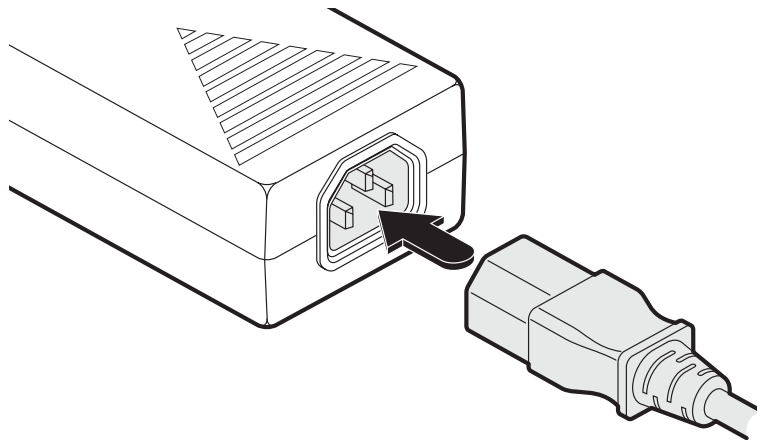

- 3 Connect the power cord to a nearby mains supply socket.

To disconnect the power adapter

- 1 Isolate the power adapter from the mains supply.
- 2 Grasp the outer body of the power adapter plug where it connects with the module.
- 3 Gently pull the body of the outer plug away from the module. As the body of the plug slides back, it will release from the socket and you can fully withdraw the whole plug.

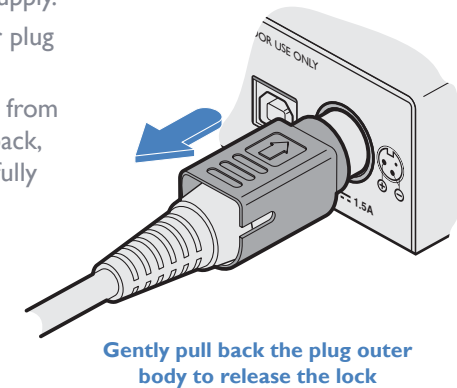

IMPORTANT: Please read and adhere to the electrical safety information given within the [Safety information](#) section of this guide. In particular, do not use an unearthed power socket or extension cable.

Note: Both the modules and the power supplies generate heat when in operation and will become warm to the touch. Do not enclose them or place them in locations where air cannot circulate to cool the equipment. Do not operate the equipment in ambient temperatures exceeding 40 degrees Centigrade. Do not place the products in contact with equipment whose surface temperature exceeds 40 degrees Centigrade.

Receiver video display

A Dual-Link DVI-D port is provided on the rear panel of the receiver module. AdderLink XD150FX can support various high resolution video modes, see [Video resolutions](#) for details.

To connect the video display

- 1 Connect the DVI-D video cable from your video display to the video output port on the rear panel of the receiver module.

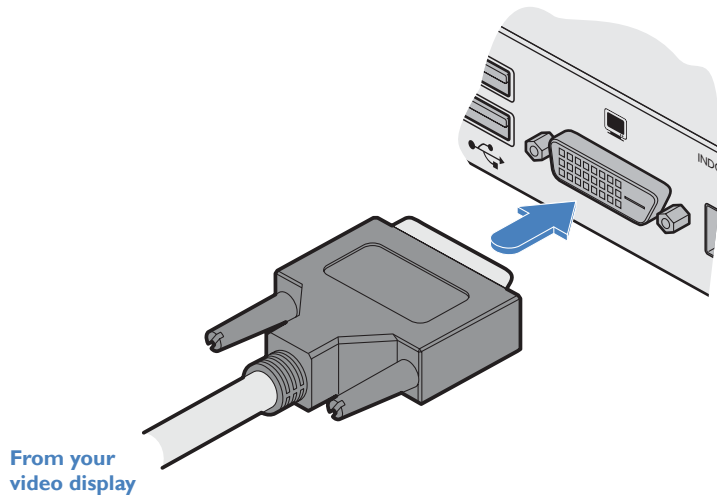
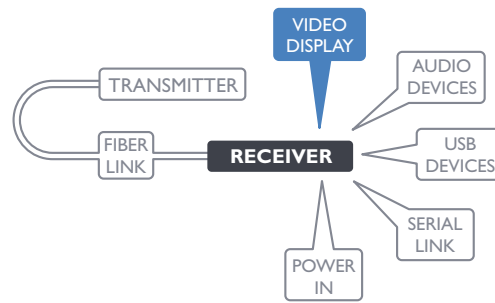

EDID management

The EDID (Extended Display Identification Data) is read from the connected video display at the receiver module; it is then transferred to, and stored within, the transmitter module and then declared to the host computer. If the video display is removed then the cloned EDID stored at the transmitter module will still be presented to the video source.

Receiver audio devices

The AdderLink XD150FX receiver module can support multiple audio devices, such as stereo headphones, a mono microphone or line-level in/out connections.

To connect audio devices

- 1 Connect stereo headphones and/or a mono microphone to the 3.5mm jack audio sockets on the front panel of the receiver module.

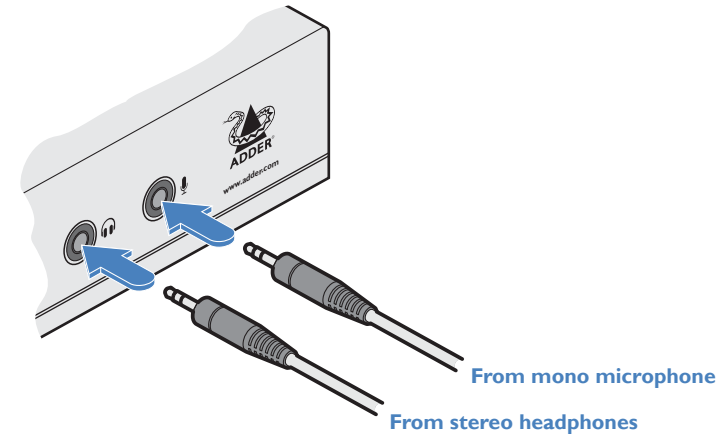
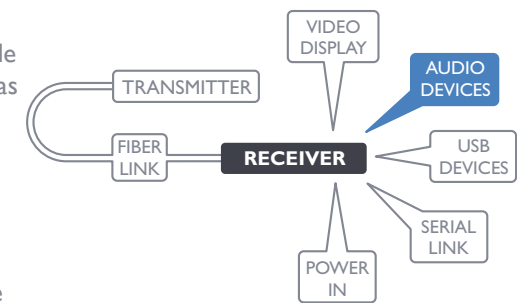

- 2 Optionally use the rear panel 3.5mm jack audio sockets to connect line-level in or out connections from audio devices, such as powered speakers.

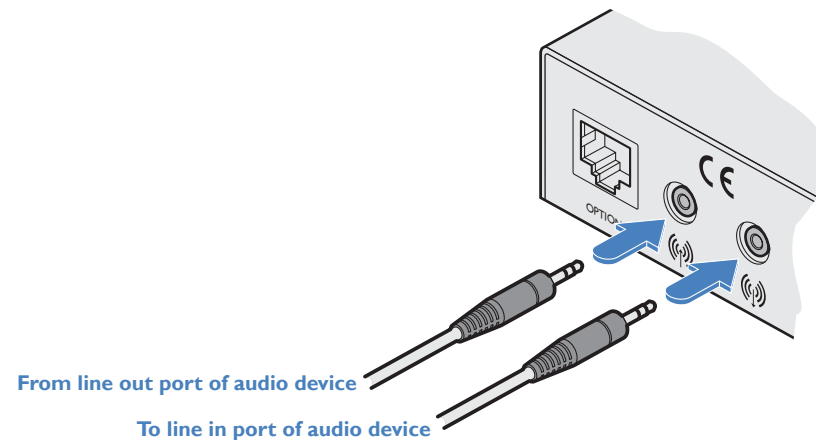

Note: If the microphone port on the front panel is used, the module will disconnect the Line In port on the rear panel.

Receiver USB devices

The receiver module contains a USB hub that can support up to four v2.0 or v1.1 USB devices (in any combination). All four USB sockets are identical in operation.

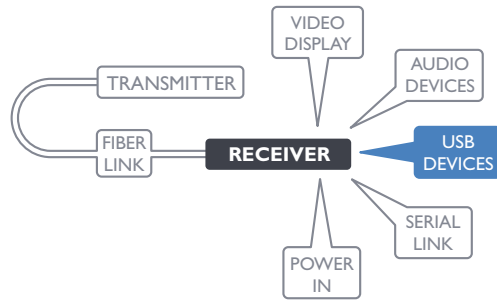

To connect USB devices

1 Connect your USB keyboard, mouse and any other two USB devices to the four sockets distributed on the front and rear panels of the receiver module.

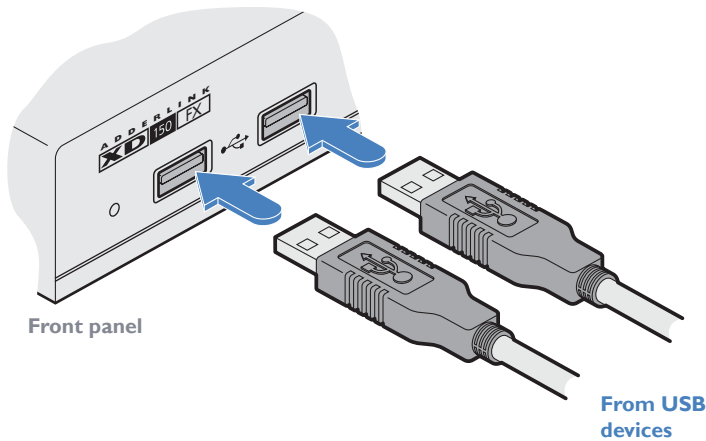
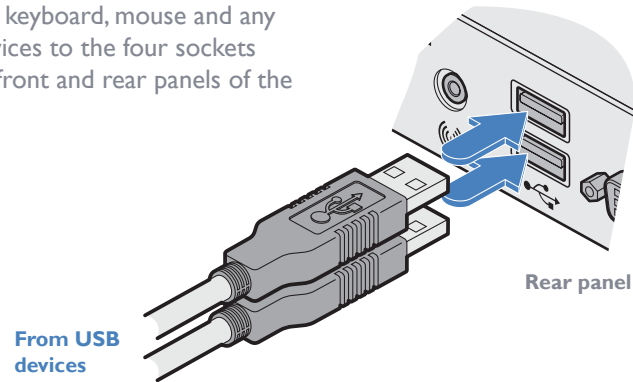

Receiver serial link

The Options port provides an RS232 serial connection with the transmitter module. When serial devices are attached to the Options ports on the transmitter and receiver modules, the units transparently convey the signals between them, via the fiber optic link, at rates up to 115200 baud - no serial configuration is required. An optional serial cable (part number: VSC45) is available from Adder.

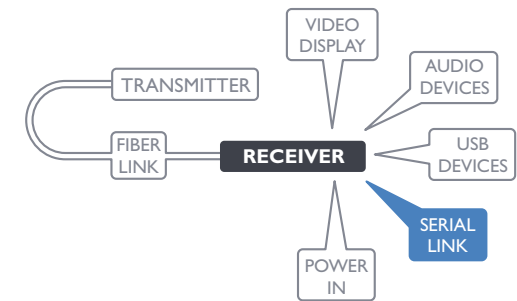

To connect the serial port

1 Use the optional serial cable (VSC45) to link the Options port on the rear panel of the receiver module with your RS232 serial device.

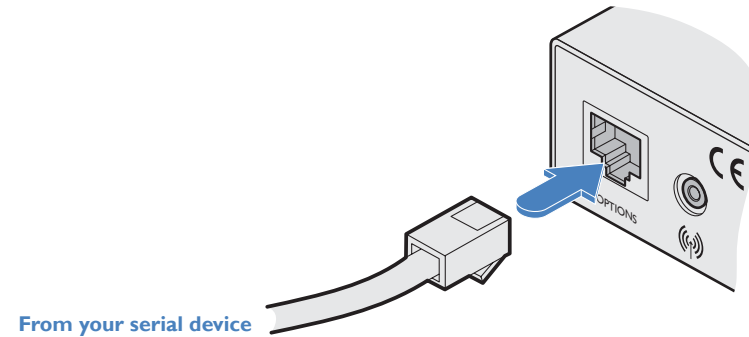

Please see [Appendix I](#) for pin-out details of the Options port.

Receiver power connection

There is no on/off switch on either of the AdderLink XD150FX modules, so operation begins as soon as power is applied. The power adapters supplied with the modules use locking-type plugs to help prevent accidental disconnections; please follow the instructions shown on the right whenever disconnecting a power adapter.

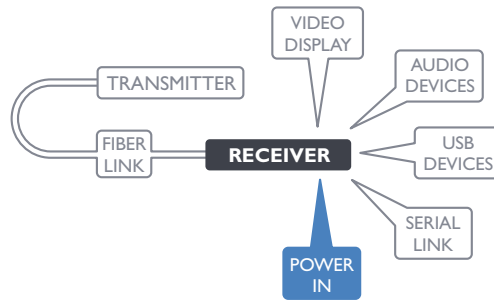

To connect the power adapter

- 1 Attach the output plug of the supplied power adapter to the power input socket on the right side of the rear panel.

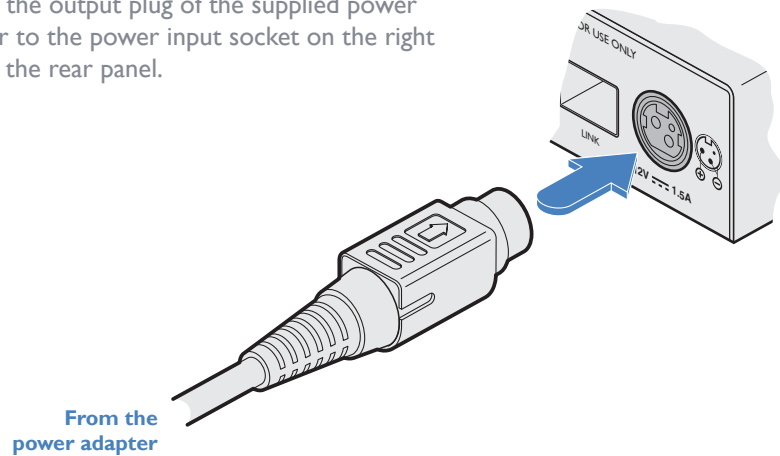

- 2 Connect the IEC connector of the supplied country-specific power cord to the socket of the power adapter.

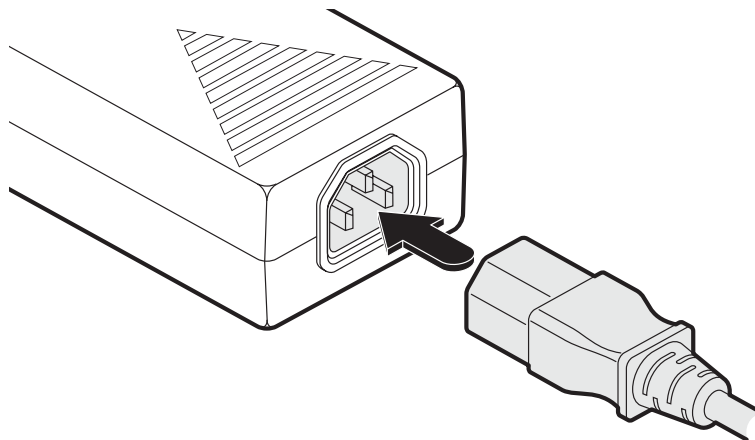

- 3 Connect the power cord to a nearby mains supply socket.

To disconnect the power adapter

- 1 Isolate the power adapter from the mains supply.
- 2 Grasp the outer body of the power adapter plug where it connects with the module.
- 3 Gently pull the body of the outer plug away from the module. As the body of the plug slides back, it will release from the socket and you can fully withdraw the whole plug.

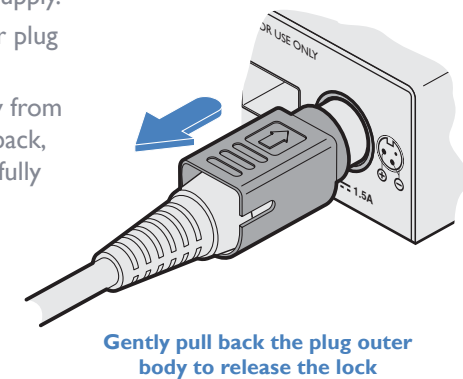

IMPORTANT: Please read and adhere to the electrical safety information given within the [Safety information](#) section of this guide. In particular, do not use an unearthed power socket or extension cable.

Note: Both the modules and the power supplies generate heat when in operation and will become warm to the touch. Do not enclose them or place them in locations where air cannot circulate to cool the equipment. Do not operate the equipment in ambient temperatures exceeding 40 degrees Centigrade. Do not place the products in contact with equipment whose surface temperature exceeds 40 degrees Centigrade.

ACCESSING THE MANAGEMENT APPLICATION

AdderLink XD150FX modules generally configure themselves automatically, collecting EDID information from the attached monitor and passing it to the host computer. In most cases the modules will begin working together correctly as soon as they are connected. Where configuration changes are required (or remote monitoring is required), the management application provides an intuitive user interface.

To access the management application

- 1 Use a computer that is directly or indirectly (i.e. via a network switch) connected to the XD150FX transmitter module. If you need to make a temporary connection, see right ➔
- 2 Run a web browser on your computer and enter the IP address of the transmitter module. By default, the IP address is set to **192.168.1.22**. If required, you can change the default IP address or alternatively, choose automated address selection by DHCP server. See the [Configure page](#).
- 3 If requested, enter the registered password to log on.

Note: The default user and password are 'admin' and 'password' respectively.

The Dashboard page should be displayed ➔

The Dashboard page shows a real-time representation of the XD150FX installation.

Use the menu on the left side to display other pages.

Use the *Online Support* option to make contact with Adder through the main website.

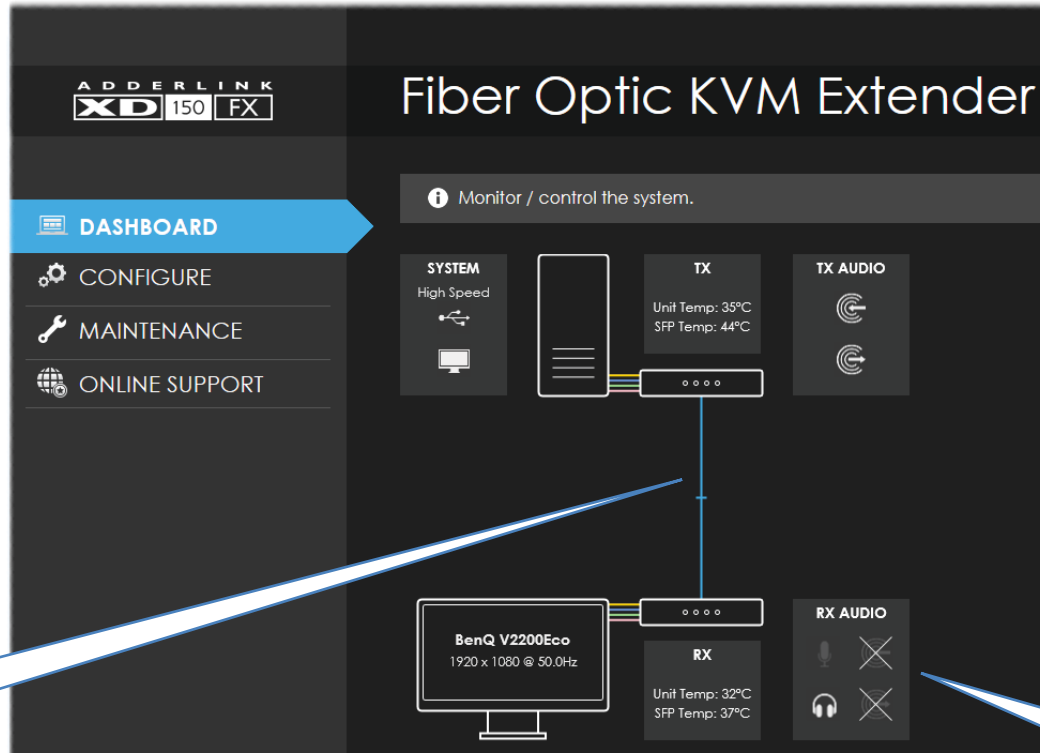

A lost fiber link is shown by a broken red line.

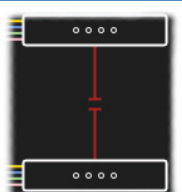

To temporarily connect a computer to the network port

- 1 If you need to make a temporary connection for configuration purposes, use a standard patch cable (cross-over or straight connections are both supported) to link the Ethernet 10/100 network port (SFP) on the rear panel of the XD150FX transmitter module to your computer's network port.

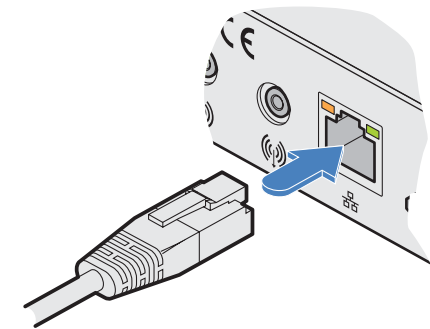

Temporary link from your computer

The appearance of the icons changes:

- **White:** Port is in use.
- **Gray:** Port not used.
- **Gray with cross:** Port is disabled.

The Configure page

The Configure page allows you to control the various peripheral feeds and also determine the network addressing details.

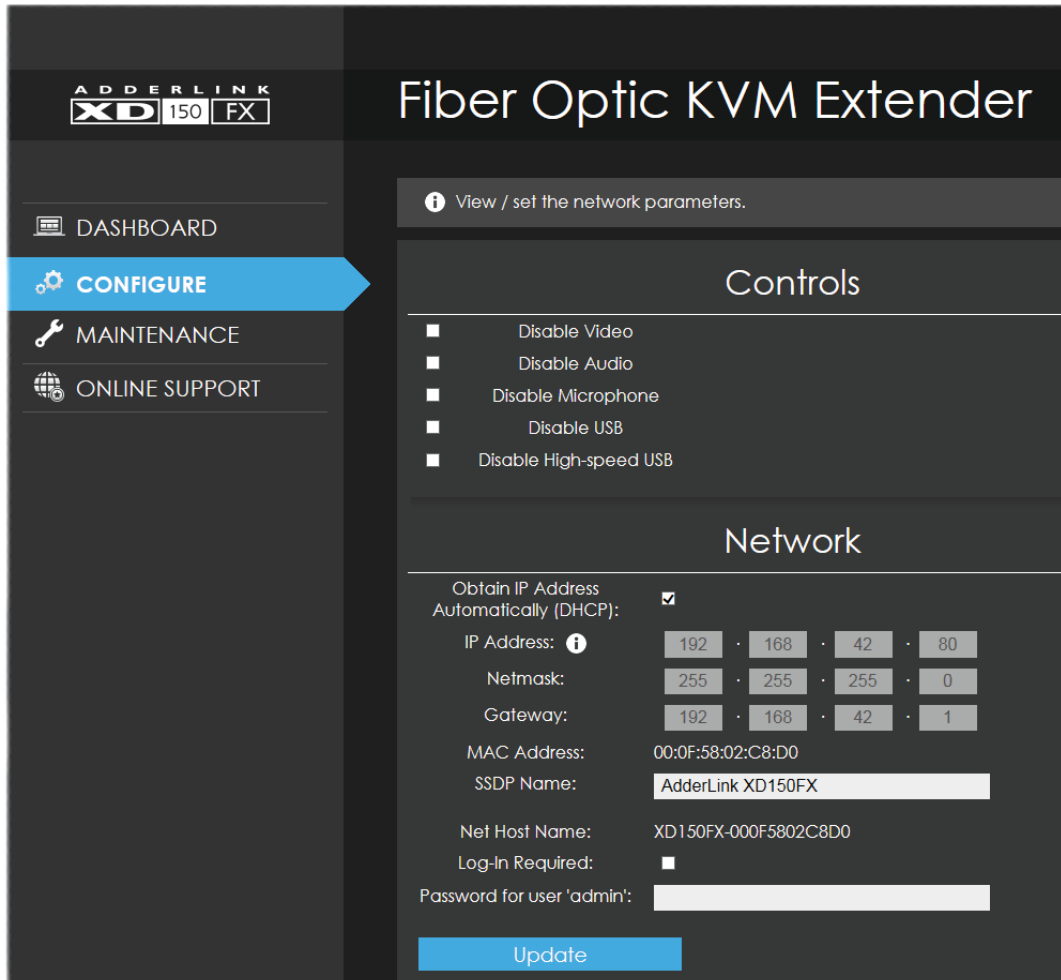

ADDER LINK
XD150FX

Fiber Optic KVM Extender

View / set the network parameters.

Controls

- Disable Video
- Disable Audio
- Disable Microphone
- Disable USB
- Disable High-speed USB

Network

Obtain IP Address Automatically (DHCP):

IP Address: · · ·

Netmask: · · ·

Gateway: · · ·

MAC Address: 00:0F:58:02:C8:D0

SSDP Name:

Net Host Name: XD150FX-000F5802C8D0

Log-In Required:

Password for user 'admin':

Update

Controls

All peripheral feeds are enabled by default. However, this section allows each feed to be disabled as required.

- *Disable High-speed USB* - this option needs to be ticked when connecting to Adder CCS-PRO8 devices.

Network

- *Obtain IP Address automatically (DHCP)* - When ticked, the transmitter module will use the DHCP (Dynamic Host Configuration Protocol) to automatically determine all network settings. When DHCP is used, the next three options are not manually editable.
- *IP Address* - set the IP address for the module.
- *Netmask* - set a subnet mask to accompany the IP address.
- *Gateway* - optionally define a suitable address for a gateway device.
- *MAC Address* - displays the unique (and fixed) MAC address for the module.
- *SSDP Name* - optionally add an identifier for this module.
- *Log-in Required* - when ticked, you will be requested to enter a user name and password.
- *Password for user 'admin'* - define a password here to be used when the 'Log In Required' option above is ticked.

Note: The default user name and password are 'admin' and 'password' respectively. Once changes are made, click the Update button to apply them.

The Maintenance page

The Maintenance page contains numerous features used for monitoring, restarting and upgrading the modules.

ADDERLINK XD 150 FX **Fiber Optic KVM Extender** **ADDER**

Restart, reset and firmware-update the device.

Transmitter		Receiver	
Firmware Version:	0.01.2166	Firmware Version:	0.01.2166
Hardware Version:	1234A6789012 / M1a	Hardware Version:	1234A6789012 / M1a
Unit Temperature:	35°C	Unit Temperature:	32°C
SFP Version:	FINISAR CORP. / FTLF8524P2BNV / PSM1GZU	SFP Version:	FINISAR CORP. / FTLF8524P2BNV / PV31S1D
SFP Temperature:	43°C	SFP Temperature:	36°C
Up-Time:	15 hours, 38 minutes, 29 seconds	Up-Time:	15 hours, 38 minutes, 33 seconds

EDID

Transmitter	Receiver
Monitor: BenQ V2200Eco	Monitor: BenQ V2200Eco
Serial Number: A4A00114026	Serial Number: A4A00114026
Raw: 00 ff ff ff ff ff ff 00 09 d1 04 7d 45 54 00 00 0e 14 01 03 80 30 1f 13 14 05 23 09 07 07 83 01 00 00 00 42 55 40 de 0c 11 80 00 1e 00 00 bf	Raw: 00 ff ff ff ff ff ff 00 09 d1 04 7d 45 54 00 00 0e 14 01 03 80 30 1f 13 14 05 23 09 07 07 83 01 00 00 00 42 55 40 de 0c 11 80 00 1e 00 00 bf

Identify Flash LED

Restart Transmitter Restart Receiver Restart

Factory Reset

WARNING: This operation will perform a full factory reset on both the receiver and the transmitter. This will reset the IP Address to 192.168.1.22.

Factory Reset

Link Quality Test 100% Link Quality Test

Firmware Upgrade

NOTE: To complete the upgrade, you may need to restart the browser or delete this app. from the browser's history.

No upgrade file is selected

Select Firmware File

Transmitter and receiver details

These twin sections list numerous details for each module:

- Firmware, hardware and SFP (optical module) versions.
- Unit (main circuit board) and SFP (optical module) temperatures.
- Up-time.
- *EDID* - lists the currently registered video monitor, together with its serial number and a full raw hex listing of the declared EDID signature.
- *Identify* - Click the *Flash LED* button to flash the front panel indicators of the chosen module. Click once for five flashes, twice for indefinite flashing and a third time to stop the flashing.
- *Restart* - If a module becomes unresponsive, click the relevant *Restart* button to reboot the required module.

Factory Reset

Click this button to perform a full factory reset on both modules. All settings will be returned to their default values; the transmitter module will default to use the IP address of **192.168.1.22**.

Link Quality Test

This section tests and displays the quality of the data link between the two modules.

Firmware Upgrade

Use this section to perform a firmware upgrade on both modules using files available on request from Adder technical support.

Note: Firmware upgrades must be performed in pairs, i.e. the transmitter and receiver together. If one of the modules is not connected, the upgrade will not be carried out.

Download the API description

Click here to view the API description in *YAML* format.

The AdderLink XD150FX modules are designed to be transparent in operation; all peripherals should respond exactly as they would when situated next to your host computer.

INDICATORS

The transmitter and receiver modules contain various indicators to provide you with status information. Both modules have four red indicators on their front panels.

Red status indicators

The red status indicators on the front panels of each module mostly behave in the same manner at the same time:

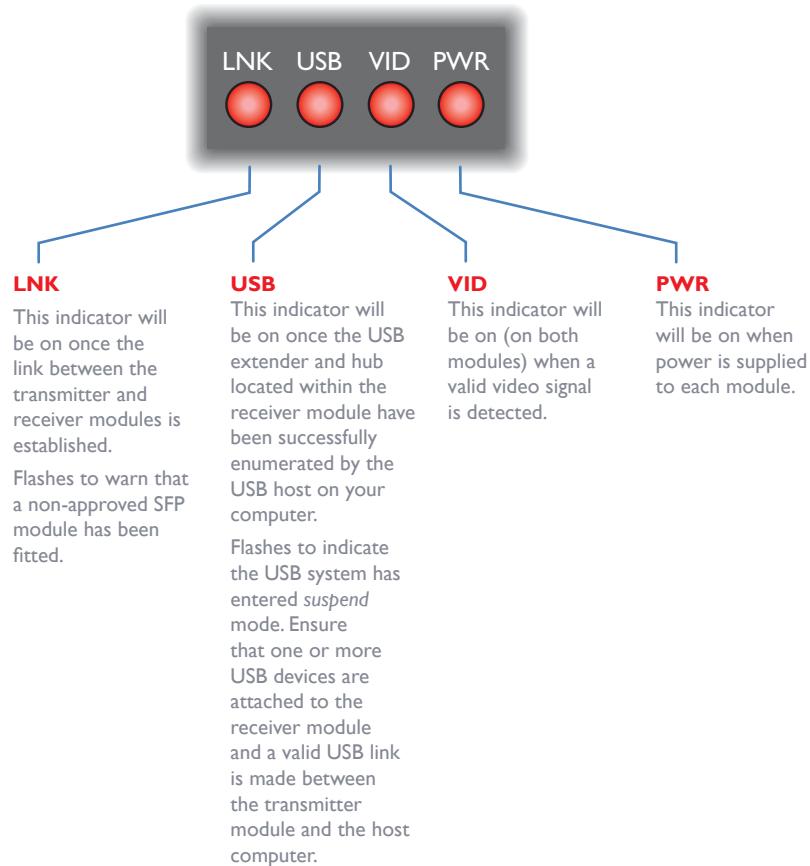

Green and amber status indicators (transmitter module only)

The green and amber status indicators on the network management port connector of the transmitter module (rear panel) provide further status information:

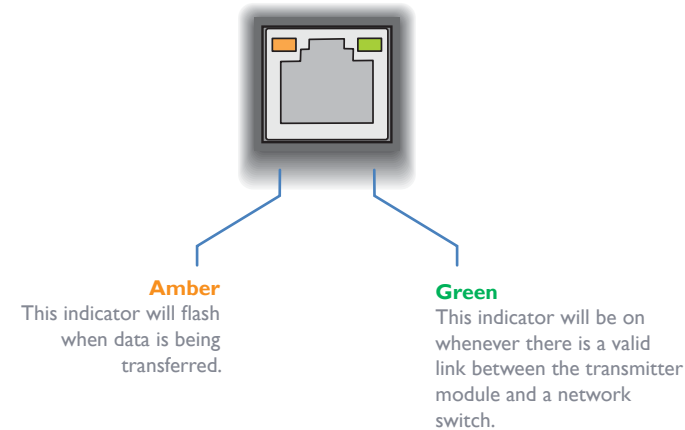

RESETTING A MODULE

On the left side of the front panel of each module, you will find a small hole which is used to invoke special functions. Use a thin implement, such as a straightened paperclip to press and hold the button concealed behind the smaller hole. Depending on when you release the button, the module will either perform a normal reset or completely reset itself to factory defaults:

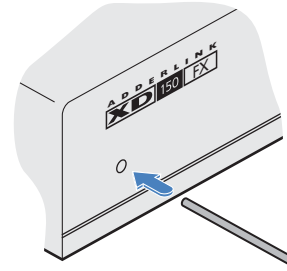

Time (seconds):	0 5 10 15
Indicator(s):	PWR: On All: Alternate flashing All: Rapid flashing together All: Normal
Release button for:	Normal restart Special configuration option (not currently used) Reset to factory defaults Return to normal operation

Further information



This chapter contains a variety of information, including the following:

- Getting assistance - see right
- [Appendix 1](#) - Options port pin-out
- [Appendix 2](#) - Open source licenses

GETTING ASSISTANCE

If you are still experiencing problems after checking the information contained within this guide, then please refer to the Support section of our website:

www.adder.com

INSTALLATION

CONFIGURATION

OPERATION

FURTHER
INFORMATION

INDEX

APPENDIX I - OPTIONS PORT PIN-OUT

The **OPTIONS** port uses a 6p6c socket. The pin-out is listed below.

Note: Although the pin labeled 'Not used' is inactive, it is still connected internally and so no links should be made at all to this pin.

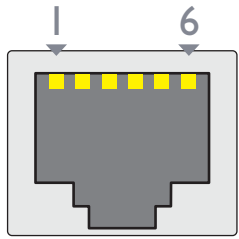

OPTIONS

Pin	Signal	Direction
1	CTSI / RXD2	<i>Input to the module</i>
2	RXD1	<i>Input to the module</i>
3	TXD1	<i>Output from the module</i>
4	RTSI / TXD2	<i>Output from the module</i>
5	Not used	
6	GND	<i>Reference for all signals</i>

APPENDIX 2 - OPEN SOURCE LICENSES

This product includes binaries that are derived from the open source community.

=====

lwIP is licenced under the BSD licence:

Copyright (c) 2001-2004 Swedish Institute of Computer Science.

All rights reserved.

Redistribution and use in source and binary forms, with or without modification, are permitted provided that the following conditions are met:

1. Redistributions of source code must retain the above copyright notice, this list of conditions and the following disclaimer.
2. Redistributions in binary form must reproduce the above copyright notice, this list of conditions and the following disclaimer in the documentation and/or other materials provided with the distribution.
3. The name of the author may not be used to endorse or promote products derived from this software without specific prior written permission.

THIS SOFTWARE IS PROVIDED BY THE AUTHOR "AS IS" AND ANY EXPRESS OR IMPLIED WARRANTIES, INCLUDING, BUT NOT LIMITED TO, THE IMPLIED WARRANTIES OF MERCHANTABILITY AND FITNESS FOR A PARTICULAR PURPOSE ARE DISCLAIMED. IN NO EVENT SHALL THE AUTHOR BE LIABLE FOR ANY DIRECT, INDIRECT, INCIDENTAL, SPECIAL, EXEMPLARY, OR CONSEQUENTIAL DAMAGES (INCLUDING, BUT NOT LIMITED TO, PROCUREMENT OF SUBSTITUTE GOODS OR SERVICES; LOSS OF USE, DATA, OR PROFITS; OR BUSINESS INTERRUPTION) HOWEVER CAUSED AND ON ANY THEORY OF LIABILITY, WHETHER IN CONTRACT, STRICT LIABILITY, OR TORT (INCLUDING NEGLIGENCE OR OTHERWISE) ARISING IN ANY WAY OUT OF THE USE OF THIS SOFTWARE, EVEN IF ADVISED OF THE POSSIBILITY OF SUCH DAMAGE.

=====

jsmn is licenced under the MIT license:

Copyright (c) 2010 Serge A. Zaitsev

Permission is hereby granted, free of charge, to any person obtaining a copy of this software and associated documentation files (the "Software"), to deal in the Software without restriction, including without limitation the rights to use, copy, modify, merge, publish, distribute, sublicense, and/or sell copies of the Software, and to permit persons to whom the Software is furnished to do so, subject to the following conditions:

The above copyright notice and this permission notice shall be included in all copies or substantial portions of the Software.

THE SOFTWARE IS PROVIDED "AS IS", WITHOUT WARRANTY OF ANY KIND, EXPRESS OR IMPLIED, INCLUDING BUT NOT LIMITED TO THE WARRANTIES OF MERCHANTABILITY, FITNESS FOR A PARTICULAR PURPOSE AND NON-INFRINGEMENT. IN NO EVENT SHALL THE AUTHORS OR COPYRIGHT HOLDERS BE LIABLE FOR ANY CLAIM, DAMAGES OR OTHER LIABILITY, WHETHER IN AN ACTION OF CONTRACT, TORT OR OTHERWISE, ARISING FROM, OUT OF OR IN CONNECTION WITH THE SOFTWARE OR THE USE OR OTHER DEALINGS IN THE SOFTWARE.

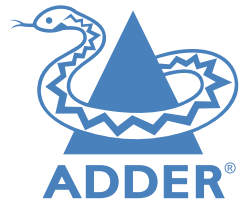

www.adder.com

Documentation by:



www.ctxd.com

© 2020 Adder Technology Limited
All trademarks are acknowledged.
Part No. MAN-XDI50FX-ADDER • Release 1.5

A

Audio
 receiver 12
 transmitter 8

C

CCS4-USB 16
CCS-PRO4 16
Connections
 overview 6

D

DDX Matrix
 accessing 15
Default mode 19
DHCP 16
Disable High-speed USB 16

E

EDID management 12

F

Firmware upgrade 17

G

Gateway 16

I

Indicators 18
IP Address 16

M

MAC Address 16

N

Net Mask 16
Network port
 temporary connection 15

P

Power
 receiver 14
 transmitter 11

R

Reset button 3
Resetting 19
RS232 9,13

S

Serial port
 receiver 13
 transmitter 9

U

USB
 receiver 13

V

Video
 receiver 12
 transmitter 8